

Service Manual

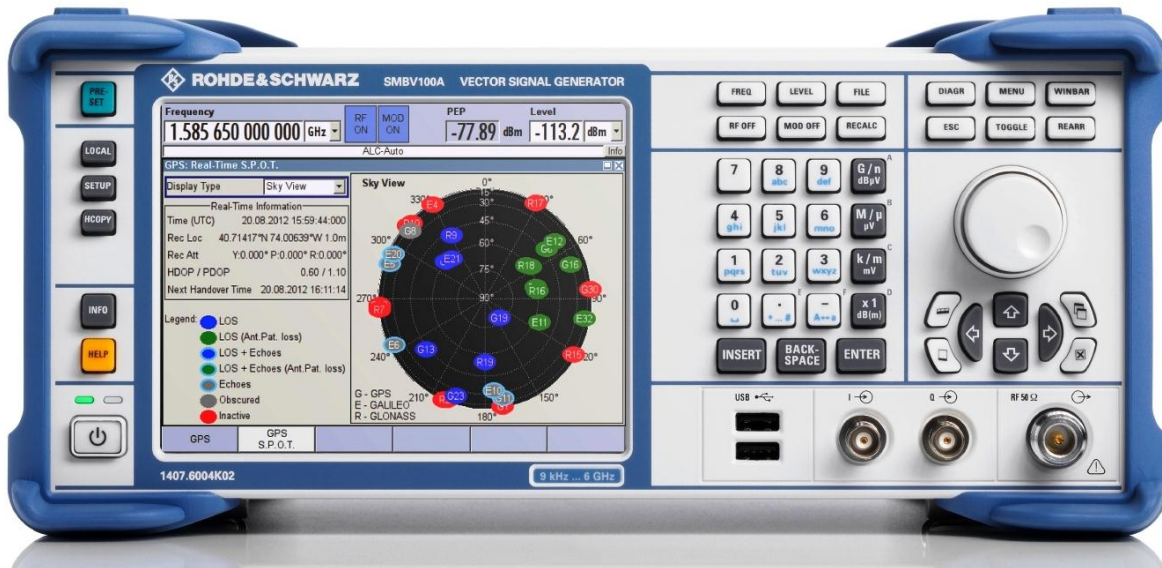

Vector Signal Generator

R&S® SMBV100A

1407.6004K02



R&S® is a registered trademark of Rohde & Schwarz GmbH & Co. KG.
Trade names are trademarks of the owners.

Chapter Overview

Index

Safety Instructions

Certificate of Quality

Customer Support

Procedure in Case of Service and Ordering of Spare Parts

Chapter 1: Performance Test

Chapter 2: Procedures after Module Replacement

Chapter 3: Repair

Chapter 4: Software Update / Installing Options

Chapter 5: Documents

Basic Safety Instructions

Always read through and comply with the following safety instructions!

All plants and locations of the Rohde & Schwarz group of companies make every effort to keep the safety standards of our products up to date and to offer our customers the highest possible degree of safety. Our products and the auxiliary equipment they require are designed, built and tested in accordance with the safety standards that apply in each case. Compliance with these standards is continuously monitored by our quality assurance system. The product described here has been designed, built and tested in accordance with the EC Certificate of Conformity and has left the manufacturer's plant in a condition fully complying with safety standards. To maintain this condition and to ensure safe operation, you must observe all instructions and warnings provided in this manual. If you have any questions regarding these safety instructions, the Rohde & Schwarz group of companies will be happy to answer them.







Furthermore, it is your responsibility to use the product in an appropriate manner. This product is designed for use solely in industrial and laboratory environments or, if expressly permitted, also in the field and must not be used in any way that may cause personal injury or property damage. You are responsible if the product is used for any purpose other than its designated purpose or in disregard of the manufacturer's instructions. The manufacturer shall assume no responsibility for such use of the product.

The product is used for its designated purpose if it is used in accordance with its product documentation and within its performance limits (see data sheet, documentation, the following safety instructions). Using the product requires technical skills and, in some cases, a basic knowledge of English. It is therefore essential that only skilled and specialized staff or thoroughly trained personnel with the required skills be allowed to use the product. If personal safety gear is required for using Rohde & Schwarz products, this will be indicated at the appropriate place in the product documentation. Keep the basic safety instructions and the product documentation in a safe place and pass them on to the subsequent users.











Observing the safety instructions will help prevent personal injury or damage of any kind caused by dangerous situations. Therefore, carefully read through and adhere to the following safety instructions before and when using the product. It is also absolutely essential to observe the additional safety instructions on personal safety, for example, that appear in relevant parts of the product documentation. In these safety instructions, the word "product" refers to all merchandise sold and distributed by the Rohde & Schwarz group of companies, including instruments, systems and all accessories. For product-specific information, see the data sheet and the product documentation.

Safety labels on products

The following safety labels are used on products to warn against risks and dangers.

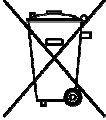
Symbol	Meaning	Symbol	Meaning
	Notice, general danger location Observe product documentation		ON/OFF supply voltage
	Caution when handling heavy equipment		Standby indication
	Danger of electric shock		Direct current (DC)

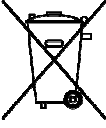
Basic Safety Instructions

Symbol	Meaning	Symbol	Meaning
	Warning! Hot surface		Alternating current (AC)
	Protective conductor terminal		Direct/alternating current (DC/AC)
	Ground		Device fully protected by double (reinforced) insulation
	Ground terminal		EU labeling for batteries and accumulators For additional information, see section "Waste disposal/Environmental protection", item 1.
	Be careful when handling electrostatic sensitive devices		EU labeling for separate collection of electrical and electronic devices For additional information, see section "Waste disposal/Environmental protection", item 2.
	Warning! Laser radiation For additional information, see section "Operation", item 7.		

Signal words and their meaning

The following signal words are used in the product documentation in order to warn the reader about risks and dangers.



Indicates a hazardous situation which, if not avoided, will result in death or serious injury.



Indicates a hazardous situation which, if not avoided, could result in death or serious injury.



Indicates a hazardous situation which, if not avoided, could result in minor or moderate injury.



Indicates information considered important, but not hazard-related, e.g. messages relating to property damage.
In the product documentation, the word ATTENTION is used synonymously.

These signal words are in accordance with the standard definition for civil applications in the European Economic Area. Definitions that deviate from the standard definition may also exist in other economic areas or military applications. It is therefore essential to make sure that the signal words described here are always used only in connection with the related product documentation and the related product. The use of signal words in connection with unrelated products or documentation can result in misinterpretation and in personal injury or material damage.

Basic Safety Instructions

Operating states and operating positions

The product may be operated only under the operating conditions and in the positions specified by the manufacturer, without the product's ventilation being obstructed. If the manufacturer's specifications are not observed, this can result in electric shock, fire and/or serious personal injury or death. Applicable local or national safety regulations and rules for the prevention of accidents must be observed in all work performed.

1. Unless otherwise specified, the following requirements apply to Rohde & Schwarz products: predefined operating position is always with the housing floor facing down, IP protection 2X, use only indoors, max. operating altitude 2000 m above sea level, max. transport altitude 4500 m above sea level. A tolerance of $\pm 10\%$ shall apply to the nominal voltage and $\pm 5\%$ to the nominal frequency, overvoltage category 2, pollution severity 2.
2. Do not place the product on surfaces, vehicles, cabinets or tables that for reasons of weight or stability are unsuitable for this purpose. Always follow the manufacturer's installation instructions when installing the product and fastening it to objects or structures (e.g. walls and shelves). An installation that is not carried out as described in the product documentation could result in personal injury or even death.
3. Do not place the product on heat-generating devices such as radiators or fan heaters. The ambient temperature must not exceed the maximum temperature specified in the product documentation or in the data sheet. Product overheating can cause electric shock, fire and/or serious personal injury or even death.

Electrical safety

If the information on electrical safety is not observed either at all or to the extent necessary, electric shock, fire and/or serious personal injury or death may occur.

1. Prior to switching on the product, always ensure that the nominal voltage setting on the product matches the nominal voltage of the AC supply network. If a different voltage is to be set, the power fuse of the product may have to be changed accordingly.
2. In the case of products of safety class I with movable power cord and connector, operation is permitted only on sockets with a protective conductor contact and protective conductor.
3. Intentionally breaking the protective conductor either in the feed line or in the product itself is not permitted. Doing so can result in the danger of an electric shock from the product. If extension cords or connector strips are implemented, they must be checked on a regular basis to ensure that they are safe to use.
4. If there is no power switch for disconnecting the product from the AC supply network, or if the power switch is not suitable for this purpose, use the plug of the connecting cable to disconnect the product from the AC supply network. In such cases, always ensure that the power plug is easily reachable and accessible at all times. For example, if the power plug is the disconnecting device, the length of the connecting cable must not exceed 3 m. Functional or electronic switches are not suitable for providing disconnection from the AC supply network. If products without power switches are integrated into racks or systems, the disconnecting device must be provided at the system level.
5. Never use the product if the power cable is damaged. Check the power cables on a regular basis to ensure that they are in proper operating condition. By taking appropriate safety measures and carefully laying the power cable, ensure that the cable cannot be damaged and that no one can be hurt by, for example, tripping over the cable or suffering an electric shock.

Basic Safety Instructions

6. The product may be operated only from TN/TT supply networks fuse-protected with max. 16 A (higher fuse only after consulting with the Rohde & Schwarz group of companies).
7. Do not insert the plug into sockets that are dusty or dirty. Insert the plug firmly and all the way into the socket provided for this purpose. Otherwise, sparks that result in fire and/or injuries may occur.
8. Do not overload any sockets, extension cords or connector strips; doing so can cause fire or electric shocks.
9. For measurements in circuits with voltages $V_{rms} > 30$ V, suitable measures (e.g. appropriate measuring equipment, fuse protection, current limiting, electrical separation, insulation) should be taken to avoid any hazards.
10. Ensure that the connections with information technology equipment, e.g. PCs or other industrial computers, comply with the IEC60950-1/EN60950-1 or IEC61010-1/EN 61010-1 standards that apply in each case.
11. Unless expressly permitted, never remove the cover or any part of the housing while the product is in operation. Doing so will expose circuits and components and can lead to injuries, fire or damage to the product.
12. If a product is to be permanently installed, the connection between the protective conductor terminal on site and the product's protective conductor must be made first before any other connection is made. The product may be installed and connected only by a licensed electrician.
13. For permanently installed equipment without built-in fuses, circuit breakers or similar protective devices, the supply circuit must be fuse-protected in such a way that anyone who has access to the product, as well as the product itself, is adequately protected from injury or damage.
14. Use suitable overvoltage protection to ensure that no overvoltage (such as that caused by a bolt of lightning) can reach the product. Otherwise, the person operating the product will be exposed to the danger of an electric shock.
15. Any object that is not designed to be placed in the openings of the housing must not be used for this purpose. Doing so can cause short circuits inside the product and/or electric shocks, fire or injuries.
16. Unless specified otherwise, products are not liquid-proof (see also section "Operating states and operating positions", item 1). Therefore, the equipment must be protected against penetration by liquids. If the necessary precautions are not taken, the user may suffer electric shock or the product itself may be damaged, which can also lead to personal injury.
17. Never use the product under conditions in which condensation has formed or can form in or on the product, e.g. if the product has been moved from a cold to a warm environment. Penetration by water increases the risk of electric shock.
18. Prior to cleaning the product, disconnect it completely from the power supply (e.g. AC supply network or battery). Use a soft, non-linting cloth to clean the product. Never use chemical cleaning agents such as alcohol, acetone or diluents for cellulose lacquers.

Operation

1. Operating the products requires special training and intense concentration. Make sure that persons who use the products are physically, mentally and emotionally fit enough to do so; otherwise, injuries or material damage may occur. It is the responsibility of the employer/operator to select suitable personnel for operating the products.

Basic Safety Instructions

2. Before you move or transport the product, read and observe the section titled "Transport".
3. As with all industrially manufactured goods, the use of substances that induce an allergic reaction (allergens) such as nickel cannot be generally excluded. If you develop an allergic reaction (such as a skin rash, frequent sneezing, red eyes or respiratory difficulties) when using a Rohde & Schwarz product, consult a physician immediately to determine the cause and to prevent health problems or stress.
4. Before you start processing the product mechanically and/or thermally, or before you take it apart, be sure to read and pay special attention to the section titled "Waste disposal/Environmental protection", item 1.
5. Depending on the function, certain products such as RF radio equipment can produce an elevated level of electromagnetic radiation. Considering that unborn babies require increased protection, pregnant women must be protected by appropriate measures. Persons with pacemakers may also be exposed to risks from electromagnetic radiation. The employer/operator must evaluate workplaces where there is a special risk of exposure to radiation and, if necessary, take measures to avert the potential danger.
6. Should a fire occur, the product may release hazardous substances (gases, fluids, etc.) that can cause health problems. Therefore, suitable measures must be taken, e.g. protective masks and protective clothing must be worn.
7. Laser products are given warning labels that are standardized according to their laser class. Lasers can cause biological harm due to the properties of their radiation and due to their extremely concentrated electromagnetic power. If a laser product (e.g. a CD/DVD drive) is integrated into a Rohde & Schwarz product, absolutely no other settings or functions may be used as described in the product documentation. The objective is to prevent personal injury (e.g. due to laser beams).
8. EMC classes (in line with EN 55011/CISPR 11, and analogously with EN 55022/CISPR 22, EN 55032/CISPR 32)
 - Class A equipment:
Equipment suitable for use in all environments except residential environments and environments that are directly connected to a low-voltage supply network that supplies residential buildings
Note: Class A equipment is intended for use in an industrial environment. This equipment may cause radio disturbances in residential environments, due to possible conducted as well as radiated disturbances. In this case, the operator may be required to take appropriate measures to eliminate these disturbances.
 - Class B equipment:
Equipment suitable for use in residential environments and environments that are directly connected to a low-voltage supply network that supplies residential buildings

Repair and service

1. The product may be opened only by authorized, specially trained personnel. Before any work is performed on the product or before the product is opened, it must be disconnected from the AC supply network. Otherwise, personnel will be exposed to the risk of an electric shock.

Basic Safety Instructions

- Adjustments, replacement of parts, maintenance and repair may be performed only by electrical experts authorized by Rohde & Schwarz. Only original parts may be used for replacing parts relevant to safety (e.g. power switches, power transformers, fuses). A safety test must always be performed after parts relevant to safety have been replaced (visual inspection, protective conductor test, insulation resistance measurement, leakage current measurement, functional test). This helps ensure the continued safety of the product.

Batteries and rechargeable batteries/cells

If the information regarding batteries and rechargeable batteries/cells is not observed either at all or to the extent necessary, product users may be exposed to the risk of explosions, fire and/or serious personal injury, and, in some cases, death. Batteries and rechargeable batteries with alkaline electrolytes (e.g. lithium cells) must be handled in accordance with the EN 62133 standard.

- Cells must not be taken apart or crushed.
- Cells or batteries must not be exposed to heat or fire. Storage in direct sunlight must be avoided. Keep cells and batteries clean and dry. Clean soiled connectors using a dry, clean cloth.
- Cells or batteries must not be short-circuited. Cells or batteries must not be stored in a box or in a drawer where they can short-circuit each other, or where they can be short-circuited by other conductive materials. Cells and batteries must not be removed from their original packaging until they are ready to be used.
- Cells and batteries must not be exposed to any mechanical shocks that are stronger than permitted.
- If a cell develops a leak, the fluid must not be allowed to come into contact with the skin or eyes. If contact occurs, wash the affected area with plenty of water and seek medical aid.
- Improperly replacing or charging cells or batteries that contain alkaline electrolytes (e.g. lithium cells) can cause explosions. Replace cells or batteries only with the matching Rohde & Schwarz type (see parts list) in order to ensure the safety of the product.
- Cells and batteries must be recycled and kept separate from residual waste. Rechargeable batteries and normal batteries that contain lead, mercury or cadmium are hazardous waste. Observe the national regulations regarding waste disposal and recycling.

Transport

- The product may be very heavy. Therefore, the product must be handled with care. In some cases, the user may require a suitable means of lifting or moving the product (e.g. with a lift-truck) to avoid back or other physical injuries.
- Handles on the products are designed exclusively to enable personnel to transport the product. It is therefore not permissible to use handles to fasten the product to or on transport equipment such as cranes, fork lifts, wagons, etc. The user is responsible for securely fastening the products to or on the means of transport or lifting. Observe the safety regulations of the manufacturer of the means of transport or lifting. Noncompliance can result in personal injury or material damage.
- If you use the product in a vehicle, it is the sole responsibility of the driver to drive the vehicle safely and properly. The manufacturer assumes no responsibility for accidents or collisions. Never use the product in a moving vehicle if doing so could distract the driver of the vehicle. Adequately secure the product in the vehicle to prevent injuries or other damage in the event of an accident.

Waste disposal/Environmental protection

1. Specially marked equipment has a battery or accumulator that must not be disposed of with unsorted municipal waste, but must be collected separately. It may only be disposed of at a suitable collection point or via a Rohde & Schwarz customer service center.
2. Waste electrical and electronic equipment must not be disposed of with unsorted municipal waste, but must be collected separately.
Rohde & Schwarz GmbH & Co. KG has developed a disposal concept and takes full responsibility for take-back obligations and disposal obligations for manufacturers within the EU. Contact your Rohde & Schwarz customer service center for environmentally responsible disposal of the product.
3. If products or their components are mechanically and/or thermally processed in a manner that goes beyond their intended use, hazardous substances (heavy-metal dust such as lead, beryllium, nickel) may be released. For this reason, the product may only be disassembled by specially trained personnel. Improper disassembly may be hazardous to your health. National waste disposal regulations must be observed.
4. If handling the product releases hazardous substances or fuels that must be disposed of in a special way, e.g. coolants or engine oils that must be replenished regularly, the safety instructions of the manufacturer of the hazardous substances or fuels and the applicable regional waste disposal regulations must be observed. Also observe the relevant safety instructions in the product documentation. The improper disposal of hazardous substances or fuels can cause health problems and lead to environmental damage.

For additional information about environmental protection, visit the Rohde & Schwarz website.

Instrucciones de seguridad elementales

¡Es imprescindible leer y cumplir las siguientes instrucciones e informaciones de seguridad!

El principio del grupo de empresas Rohde & Schwarz consiste en tener nuestros productos siempre al día con los estándares de seguridad y de ofrecer a nuestros clientes el máximo grado de seguridad. Nuestros productos y todos los equipos adicionales son siempre fabricados y examinados según las normas de seguridad vigentes. Nuestro sistema de garantía de calidad controla constantemente que sean cumplidas estas normas. El presente producto ha sido fabricado y examinado según el certificado de conformidad de la UE y ha salido de nuestra planta en estado impecable según los estándares técnicos de seguridad. Para poder preservar este estado y garantizar un funcionamiento libre de peligros, el usuario deberá atenerse a todas las indicaciones, informaciones de seguridad y notas de alerta. El grupo de empresas Rohde & Schwarz está siempre a su disposición en caso de que tengan preguntas referentes a estas informaciones de seguridad.

Además queda en la responsabilidad del usuario utilizar el producto en la forma debida. Este producto está destinado exclusivamente al uso en la industria y el laboratorio o, si ha sido expresamente autorizado, para aplicaciones de campo y de ninguna manera deberá ser utilizado de modo que alguna persona/cosa pueda sufrir daño. El uso del producto fuera de sus fines definidos o sin tener en cuenta las instrucciones del fabricante queda en la responsabilidad del usuario. El fabricante no se hace en ninguna forma responsable de consecuencias a causa del mal uso del producto.















Instrucciones de seguridad elementales

Se parte del uso correcto del producto para los fines definidos si el producto es utilizado conforme a las indicaciones de la correspondiente documentación del producto y dentro del margen de rendimiento definido (ver hoja de datos, documentación, informaciones de seguridad que siguen). El uso del producto hace necesarios conocimientos técnicos y ciertos conocimientos del idioma inglés. Por eso se debe tener en cuenta que el producto solo pueda ser operado por personal especializado o personas instruidas en profundidad con las capacidades correspondientes. Si fuera necesaria indumentaria de seguridad para el uso de productos de Rohde & Schwarz, encontraría la información debida en la documentación del producto en el capítulo correspondiente. Guarde bien las informaciones de seguridad elementales, así como la documentación del producto, y entréguelas a usuarios posteriores.



Tener en cuenta las informaciones de seguridad sirve para evitar en lo posible lesiones o daños por peligros de toda clase. Por eso es imprescindible leer detalladamente y comprender por completo las siguientes informaciones de seguridad antes de usar el producto, y respetarlas durante el uso del producto. Deberán tenerse en cuenta todas las demás informaciones de seguridad, como p. ej. las referentes a la protección de personas, que encontrarán en el capítulo correspondiente de la documentación del producto y que también son de obligado cumplimiento. En las presentes informaciones de seguridad se recogen todos los objetos que distribuye el grupo de empresas Rohde & Schwarz bajo la denominación de "producto", entre ellos también aparatos, instalaciones así como toda clase de accesorios. Los datos específicos del producto figuran en la hoja de datos y en la documentación del producto.

Señalización de seguridad de los productos

Las siguientes señales de seguridad se utilizan en los productos para advertir sobre riesgos y peligros.

Símbolo	Significado	Símbolo	Significado
	Aviso: punto de peligro general Observar la documentación del producto		Tensión de alimentación de PUESTA EN MARCHA / PARADA
	Atención en el manejo de dispositivos de peso elevado		Indicación de estado de espera (standby)
	Peligro de choque eléctrico		Corriente continua (DC)
	Advertencia: superficie caliente		Corriente alterna (AC)
	Conexión a conductor de protección		Corriente continua / Corriente alterna (DC/AC)
	Conexión a tierra		El aparato está protegido en su totalidad por un aislamiento doble (reforzado)
	Conexión a masa		Distintivo de la UE para baterías y acumuladores Más información en la sección "Eliminación/protección del medio ambiente", punto 1.

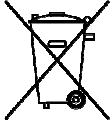
Instrucciones de seguridad elementales

Símbolo	Significado	Símbolo	Significado
	Aviso: Cuidado en el manejo de dispositivos sensibles a la electrostática (ESD)		Distintivo de la UE para la eliminación por separado de dispositivos eléctricos y electrónicos Más información en la sección "Eliminación/protección del medio ambiente", punto 2.
	Advertencia: rayo láser Más información en la sección "Funcionamiento", punto 7.		

Palabras de señal y su significado

En la documentación del producto se utilizan las siguientes palabras de señal con el fin de advertir contra riesgos y peligros.



Indica una situación de peligro que, si no se evita, causa lesiones graves o incluso la muerte.



Indica una situación de peligro que, si no se evita, puede causar lesiones graves o incluso la muerte.



Indica una situación de peligro que, si no se evita, puede causar lesiones leves o moderadas.



Indica información que se considera importante, pero no en relación con situaciones de peligro; p. ej., avisos sobre posibles daños materiales.

En la documentación del producto se emplea de forma sinónima el término CUIDADO.

Las palabras de señal corresponden a la definición habitual para aplicaciones civiles en el área económica europea. Pueden existir definiciones diferentes a esta definición en otras áreas económicas o en aplicaciones militares. Por eso se deberá tener en cuenta que las palabras de señal aquí descritas sean utilizadas siempre solamente en combinación con la correspondiente documentación del producto y solamente en combinación con el producto correspondiente. La utilización de las palabras de señal en combinación con productos o documentaciones que no les correspondan puede llevar a interpretaciones equivocadas y tener por consecuencia daños en personas u objetos.

Estados operativos y posiciones de funcionamiento

El producto solamente debe ser utilizado según lo indicado por el fabricante respecto a los estados operativos y posiciones de funcionamiento sin que se obstruya la ventilación. Si no se siguen las indicaciones del fabricante, pueden producirse choques eléctricos, incendios y/o lesiones graves con posible consecuencia de muerte. En todos los trabajos deberán ser tenidas en cuenta las normas nacionales y locales de seguridad del trabajo y de prevención de accidentes.

Instrucciones de seguridad elementales

1. Si no se convino de otra manera, es para los productos Rohde & Schwarz válido lo que sigue: como posición de funcionamiento se define por principio la posición con el suelo de la caja para abajo, modo de protección IP 2X, uso solamente en estancias interiores, utilización hasta 2000 m sobre el nivel del mar, transporte hasta 4500 m sobre el nivel del mar. Se aplicará una tolerancia de $\pm 10\%$ sobre el voltaje nominal y de $\pm 5\%$ sobre la frecuencia nominal. Categoría de sobrecarga eléctrica 2, índice de suciedad 2.
2. No sitúe el producto encima de superficies, vehículos, estantes o mesas, que por sus características de peso o de estabilidad no sean aptos para él. Siga siempre las instrucciones de instalación del fabricante cuando instale y asegure el producto en objetos o estructuras (p. ej. paredes y estantes). Si se realiza la instalación de modo distinto al indicado en la documentación del producto, se pueden causar lesiones o, en determinadas circunstancias, incluso la muerte.
3. No ponga el producto sobre aparatos que generen calor (p. ej. radiadores o calefactores). La temperatura ambiente no debe superar la temperatura máxima especificada en la documentación del producto o en la hoja de datos. En caso de sobrecalentamiento del producto, pueden producirse choques eléctricos, incendios y/o lesiones graves con posible consecuencia de muerte.

Seguridad eléctrica

Si no se siguen (o se siguen de modo insuficiente) las indicaciones del fabricante en cuanto a seguridad eléctrica, pueden producirse choques eléctricos, incendios y/o lesiones graves con posible consecuencia de muerte.

1. Antes de la puesta en marcha del producto se deberá comprobar siempre que la tensión preseleccionada en el producto coincida con la de la red de alimentación eléctrica. Si es necesario modificar el ajuste de tensión, también se deberán cambiar en caso dado los fusibles correspondientes del producto.
2. Los productos de la clase de protección I con alimentación móvil y enchufe individual solamente podrán enchufarse a tomas de corriente con contacto de seguridad y con conductor de protección conectado.
3. Queda prohibida la interrupción intencionada del conductor de protección, tanto en la toma de corriente como en el mismo producto. La interrupción puede tener como consecuencia el riesgo de que el producto sea fuente de choques eléctricos. Si se utilizan cables alargadores o regletas de enchufe, deberá garantizarse la realización de un examen regular de los mismos en cuanto a su estado técnico de seguridad.
4. Si el producto no está equipado con un interruptor para desconectarlo de la red, o bien si el interruptor existente no resulta apropiado para la desconexión de la red, el enchufe del cable de conexión se deberá considerar como un dispositivo de desconexión. El dispositivo de desconexión se debe poder alcanzar fácilmente y debe estar siempre bien accesible. Si, p. ej., el enchufe de conexión a la red es el dispositivo de desconexión, la longitud del cable de conexión no debe superar 3 m). Los interruptores selectores o electrónicos no son aptos para el corte de la red eléctrica. Si se integran productos sin interruptor en bastidores o instalaciones, se deberá colocar el interruptor en el nivel de la instalación.
5. No utilice nunca el producto si está dañado el cable de conexión a red. Compruebe regularmente el correcto estado de los cables de conexión a red. Asegúrese, mediante las medidas de protección y de instalación adecuadas, de que el cable de conexión a red no pueda ser dañado o de que nadie pueda ser dañado por él, p. ej. al tropezar o por un choque eléctrico.

Instrucciones de seguridad elementales

6. Solamente está permitido el funcionamiento en redes de alimentación TN/TT aseguradas con fusibles de 16 A como máximo (utilización de fusibles de mayor amperaje solo previa consulta con el grupo de empresas Rohde & Schwarz).
7. Nunca conecte el enchufe en tomas de corriente sucias o llenas de polvo. Introduzca el enchufe por completo y fuertemente en la toma de corriente. La no observación de estas medidas puede provocar chispas, fuego y/o lesiones.
8. No sobrecargue las tomas de corriente, los cables alargadores o las regletas de enchufe ya que esto podría causar fuego o choques eléctricos.
9. En las mediciones en circuitos de corriente con una tensión $U_{\text{eff}} > 30 \text{ V}$ se deberán tomar las medidas apropiadas para impedir cualquier peligro (p. ej. medios de medición adecuados, seguros, limitación de tensión, corte protector, aislamiento etc.).
10. Para la conexión con dispositivos informáticos como un PC o un ordenador industrial, debe comprobarse que éstos cumplan los estándares IEC60950-1/EN60950-1 o IEC61010-1/EN 61010-1 válidos en cada caso.
11. A menos que esté permitido expresamente, no retire nunca la tapa ni componentes de la carcasa mientras el producto esté en servicio. Esto pone a descubierto los cables y componentes eléctricos y puede causar lesiones, fuego o daños en el producto.
12. Si un producto se instala en un lugar fijo, se deberá primero conectar el conductor de protección fijo con el conductor de protección del producto antes de hacer cualquier otra conexión. La instalación y la conexión deberán ser efectuadas por un electricista especializado.
13. En el caso de dispositivos fijos que no estén provistos de fusibles, interruptor automático ni otros mecanismos de seguridad similares, el circuito de alimentación debe estar protegido de modo que todas las personas que puedan acceder al producto, así como el producto mismo, estén a salvo de posibles daños.
14. Todo producto debe estar protegido contra sobretensión (debida p. ej. a una caída del rayo) mediante los correspondientes sistemas de protección. Si no, el personal que lo utilice quedará expuesto al peligro de choque eléctrico.
15. No debe introducirse en los orificios de la caja del aparato ningún objeto que no esté destinado a ello. Esto puede producir cortocircuitos en el producto y/o puede causar choques eléctricos, fuego o lesiones.
16. Salvo indicación contraria, los productos no están impermeabilizados (ver también el capítulo "Estados operativos y posiciones de funcionamiento", punto 1). Por eso es necesario tomar las medidas necesarias para evitar la entrada de líquidos. En caso contrario, existe peligro de choque eléctrico para el usuario o de daños en el producto, que también pueden redundar en peligro para las personas.
17. No utilice el producto en condiciones en las que pueda producirse o ya se hayan producido condensaciones sobre el producto o en el interior de éste, como p. ej. al desplazarlo de un lugar frío a otro caliente. La entrada de agua aumenta el riesgo de choque eléctrico.
18. Antes de la limpieza, desconecte por completo el producto de la alimentación de tensión (p. ej. red de alimentación o batería). Realice la limpieza de los aparatos con un paño suave, que no se deshilache. No utilice bajo ningún concepto productos de limpieza químicos como alcohol, acetona o diluyentes para lacas nitrocelulósicas.

Funcionamiento

1. El uso del producto requiere instrucciones especiales y una alta concentración durante el manejo. Debe asegurarse que las personas que manejen el producto estén a la altura de los requerimientos necesarios en cuanto a aptitudes físicas, psíquicas y emocionales, ya que de otra manera no se pueden excluir lesiones o daños de objetos. El empresario u operador es responsable de seleccionar el personal usuario apto para el manejo del producto.
2. Antes de desplazar o transportar el producto, lea y tenga en cuenta el capítulo "Transporte".
3. Como con todo producto de fabricación industrial no puede quedar excluida en general la posibilidad de que se produzcan alergias provocadas por algunos materiales empleados —los llamados alérgenos (p. ej. el níquel)—. Si durante el manejo de productos Rohde & Schwarz se producen reacciones alérgicas, como p. ej. irritaciones cutáneas, estornudos continuos, enrojecimiento de la conjuntiva o dificultades respiratorias, debe avisarse inmediatamente a un médico para investigar las causas y evitar cualquier molestia o daño a la salud.
4. Antes de la manipulación mecánica y/o térmica o el desmontaje del producto, debe tenerse en cuenta imprescindiblemente el capítulo "Eliminación/protección del medio ambiente", punto 1.
5. Ciertos productos, como p. ej. las instalaciones de radiocomunicación RF, pueden a causa de su función natural, emitir una radiación electromagnética aumentada. Deben tomarse todas las medidas necesarias para la protección de las mujeres embarazadas. También las personas con marcapasos pueden correr peligro a causa de la radiación electromagnética. El empresario/operador tiene la obligación de evaluar y señalizar las áreas de trabajo en las que exista un riesgo elevado de exposición a radiaciones.
6. Tenga en cuenta que en caso de incendio pueden desprenderse del producto sustancias tóxicas (gases, líquidos etc.) que pueden generar daños a la salud. Por eso, en caso de incendio deben usarse medidas adecuadas, como p. ej. máscaras antigás e indumentaria de protección.
7. Los productos con láser están provistos de indicaciones de advertencia normalizadas en función de la clase de láser del que se trate. Los rayos láser pueden provocar daños de tipo biológico a causa de las propiedades de su radiación y debido a su concentración extrema de potencia electromagnética. En caso de que un producto Rohde & Schwarz contenga un producto láser (p. ej. un lector de CD/DVD), no debe usarse ninguna otra configuración o función aparte de las descritas en la documentación del producto, a fin de evitar lesiones (p. ej. debidas a irradiación láser).
8. Clases de compatibilidad electromagnética (conforme a EN 55011 / CISPR 11; y en analogía con EN 55022 / CISPR 22, EN 55032 / CISPR 32)
 - Aparato de clase A:
Aparato adecuado para su uso en todos los entornos excepto en los residenciales y en aquellos conectados directamente a una red de distribución de baja tensión que suministra corriente a edificios residenciales.
Nota: Los aparatos de clase A están destinados al uso en entornos industriales. Estos aparatos pueden causar perturbaciones radioeléctricas en entornos residenciales debido a posibles perturbaciones guiadas o radiadas. En este caso, se le podrá solicitar al operador que tome las medidas adecuadas para eliminar estas perturbaciones.
 - Aparato de clase B:
Aparato adecuado para su uso en entornos residenciales, así como en aquellos conectados directamente a una red de distribución de baja tensión que suministra corriente a edificios residenciales.

Reparación y mantenimiento

1. El producto solamente debe ser abierto por personal especializado con autorización para ello. Antes de manipular el producto o abrirlo, es obligatorio desconectarlo de la tensión de alimentación, para evitar toda posibilidad de choque eléctrico.
2. El ajuste, el cambio de partes, el mantenimiento y la reparación deberán ser efectuadas solamente por electricistas autorizados por Rohde & Schwarz. Si se reponen partes con importancia para los aspectos de seguridad (p. ej. el enchufe, los transformadores o los fusibles), solamente podrán ser sustituidos por partes originales. Después de cada cambio de partes relevantes para la seguridad deberá realizarse un control de seguridad (control a primera vista, control del conductor de protección, medición de resistencia de aislamiento, medición de la corriente de fuga, control de funcionamiento). Con esto queda garantizada la seguridad del producto.

Baterías y acumuladores o celdas

Si no se siguen (o se siguen de modo insuficiente) las indicaciones en cuanto a las baterías y acumuladores o celdas, pueden producirse explosiones, incendios y/o lesiones graves con posible consecuencia de muerte. El manejo de baterías y acumuladores con electrolitos alcalinos (p. ej. celdas de litio) debe seguir el estándar EN 62133.

1. No deben desmontarse, abrirse ni triturarse las celdas.
2. Las celdas o baterías no deben someterse a calor ni fuego. Debe evitarse el almacenamiento a la luz directa del sol. Las celdas y baterías deben mantenerse limpias y secas. Limpiar las conexiones sucias con un paño seco y limpio.
3. Las celdas o baterías no deben cortocircuitarse. Es peligroso almacenar las celdas o baterías en estuches o cajones en cuyo interior puedan cortocircuitarse por contacto recíproco o por contacto con otros materiales conductores. No deben extraerse las celdas o baterías de sus embalajes originales hasta el momento en que vayan a utilizarse.
4. Las celdas o baterías no deben someterse a impactos mecánicos fuertes indebidos.
5. En caso de falta de estanqueidad de una celda, el líquido vertido no debe entrar en contacto con la piel ni los ojos. Si se produce contacto, lavar con agua abundante la zona afectada y avisar a un médico.
6. En caso de cambio o recarga inadecuados, las celdas o baterías que contienen electrolitos alcalinos (p. ej. las celdas de litio) pueden explotar. Para garantizar la seguridad del producto, las celdas o baterías solo deben ser sustituidas por el tipo Rohde & Schwarz correspondiente (ver lista de recambios).
7. Las baterías y celdas deben reciclarse y no deben tirarse a la basura doméstica. Las baterías o acumuladores que contienen plomo, mercurio o cadmio deben tratarse como residuos especiales. Respete en esta relación las normas nacionales de eliminación y reciclaje.

Transporte

1. El producto puede tener un peso elevado. Por eso es necesario desplazarlo o transportarlo con precaución y, si es necesario, usando un sistema de elevación adecuado (p. ej. una carretilla elevadora), a fin de evitar lesiones en la espalda u otros daños personales.

Instrucciones de seguridad elementales

2. Las asas instaladas en los productos sirven solamente de ayuda para el transporte del producto por personas. Por eso no está permitido utilizar las asas para la sujeción en o sobre medios de transporte como p. ej. grúas, carretillas elevadoras de horquilla, carros etc. Es responsabilidad suya fijar los productos de manera segura a los medios de transporte o elevación. Para evitar daños personales o daños en el producto, siga las instrucciones de seguridad del fabricante del medio de transporte o elevación utilizado.
3. Si se utiliza el producto dentro de un vehículo, recae de manera exclusiva en el conductor la responsabilidad de conducir el vehículo de manera segura y adecuada. El fabricante no asumirá ninguna responsabilidad por accidentes o colisiones. No utilice nunca el producto dentro de un vehículo en movimiento si esto pudiera distraer al conductor. Asegure el producto dentro del vehículo debidamente para evitar, en caso de un accidente, lesiones u otra clase de daños.

Eliminación/protección del medio ambiente

1. Los dispositivos marcados contienen una batería o un acumulador que no se debe desechar con los residuos domésticos sin clasificar, sino que debe ser recogido por separado. La eliminación se debe efectuar exclusivamente a través de un punto de recogida apropiado o del servicio de atención al cliente de Rohde & Schwarz.
2. Los dispositivos eléctricos usados no se deben desechar con los residuos domésticos sin clasificar, sino que deben ser recogidos por separado.
Rohde & Schwarz GmbH & Co.KG ha elaborado un concepto de eliminación de residuos y asume plenamente los deberes de recogida y eliminación para los fabricantes dentro de la UE. Para desechar el producto de manera respetuosa con el medio ambiente, diríjase a su servicio de atención al cliente de Rohde & Schwarz.
3. Si se trabaja de manera mecánica y/o térmica cualquier producto o componente más allá del funcionamiento previsto, pueden liberarse sustancias peligrosas (povos con contenido de metales pesados como p. ej. plomo, berilio o níquel). Por eso el producto solo debe ser desmontado por personal especializado con formación adecuada. Un desmontaje inadecuado puede ocasionar daños para la salud. Se deben tener en cuenta las directivas nacionales referentes a la eliminación de residuos.
4. En caso de que durante el trato del producto se formen sustancias peligrosas o combustibles que deban tratarse como residuos especiales (p. ej. refrigerantes o aceites de motor con intervalos de cambio definidos), deben tenerse en cuenta las indicaciones de seguridad del fabricante de dichas sustancias y las normas regionales de eliminación de residuos. Tenga en cuenta también en caso necesario las indicaciones de seguridad especiales contenidas en la documentación del producto. La eliminación incorrecta de sustancias peligrosas o combustibles puede causar daños a la salud o daños al medio ambiente.

Se puede encontrar más información sobre la protección del medio ambiente en la página web de Rohde & Schwarz.

Instructions for Electrostatic Discharge Protection

NOTICE

Risk of damaging electronic components

To avoid damage of electronic components, the operational site must be protected against electrostatic discharge (ESD).

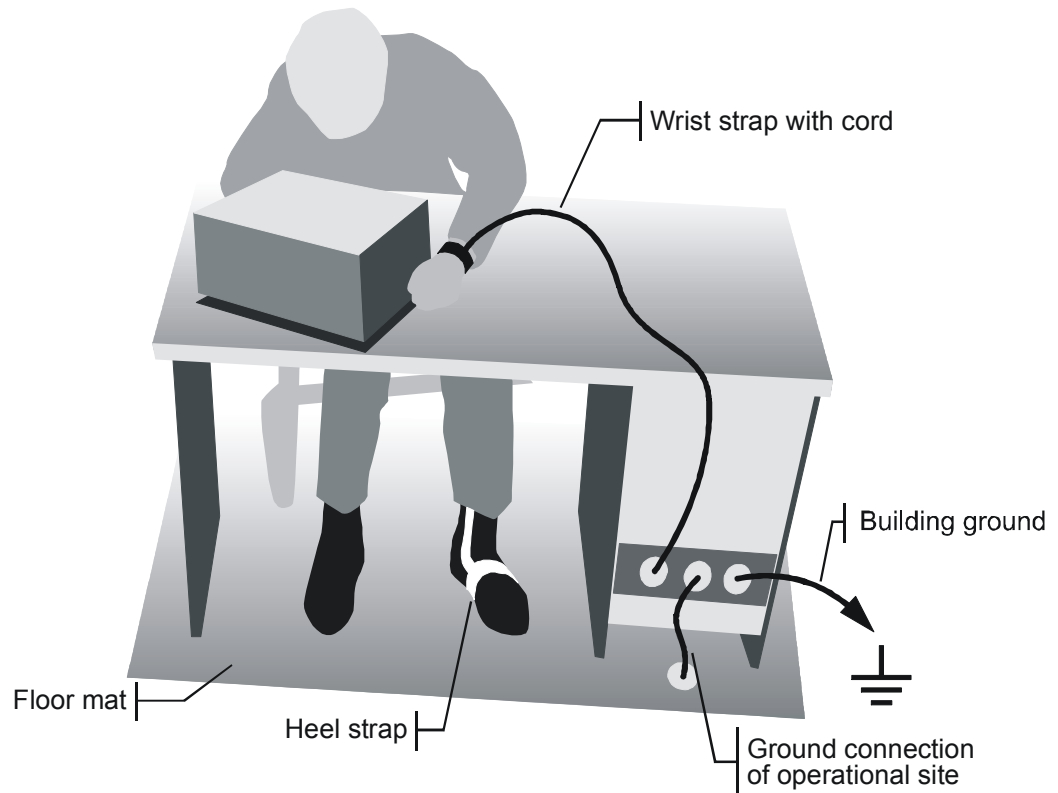

The following two methods of ESD protection may be used together or separately:

- Wrist strap with cord to ground connection
 - Conductive floor mat and heel strap combination
-

Instrucciones para la protección contra descargas electrostáticas

AVISO

Riesgo de avería de los componentes electrónicos

Para evitar averías en los componentes electrónicos, el área de trabajo tiene que estar protegido contra descargas electrostáticas ESD (electrostatic discharge).

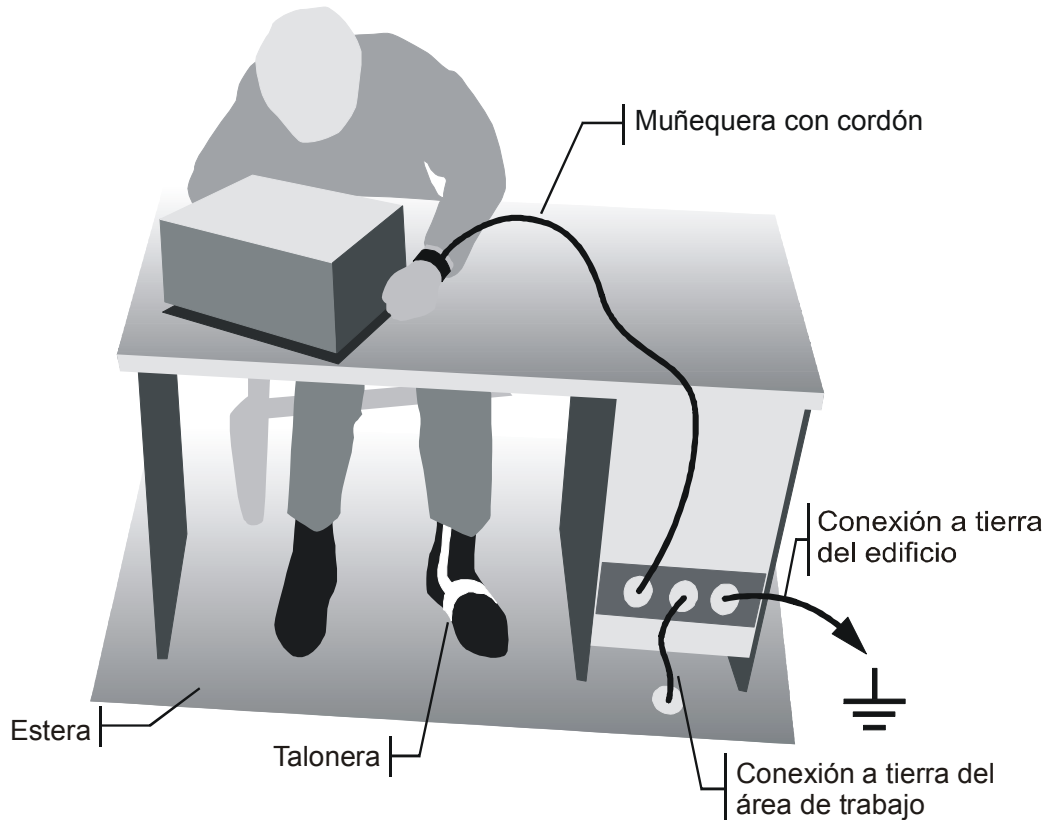

Los siguientes dos métodos de protección ESD pueden ser usados juntos o separados:

- Muñequera con cordón para conexión a tierra
- Combinación de estera antiestática y talonera

Safety Instructions for Units with Removable Cabinet

⚠ WARNING

Danger of injuries

When removing the rear feet, the unit can slip out of the cabinet.

Put the unit onto the front handles, before removing the rear feet and taking off the cabinet. Thus the risk of personal injuries and damages to the unit is avoided.

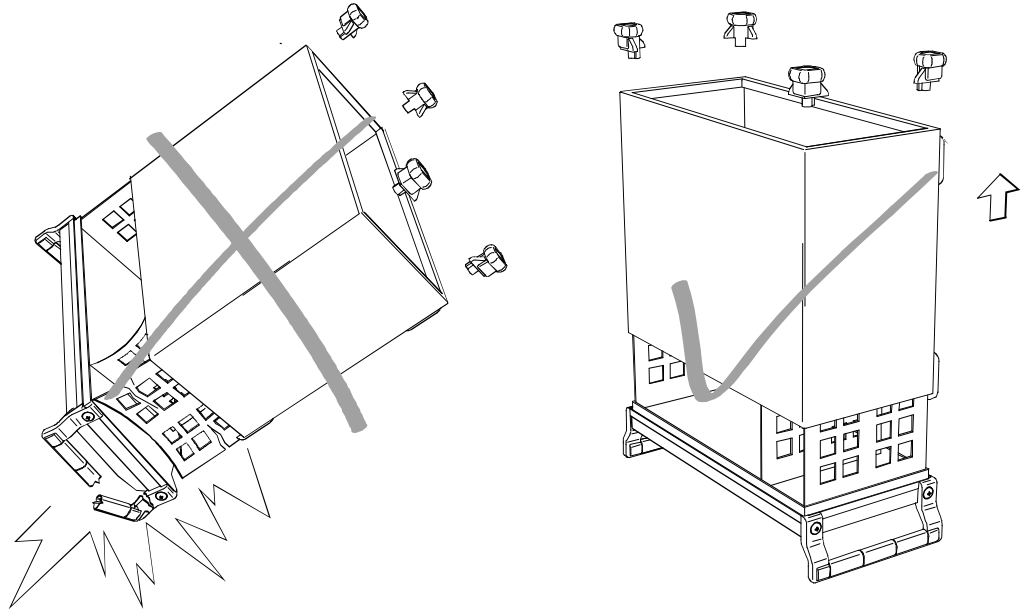

When mounting the cabinet take care not to pen in the fingers. Also pay attention not to damage or pull off cables. Screw the rear feet back on immediately after mounting the cabinet. Do not move the unit with the rear feet missing.

Informaciones de seguridad para aparatos con tubo de quita y pon

⚠ ADVERTENCIA

Peligro de heridas

Al sacar los piés de la pared posterior puede deslizarse el aparato fuera de la caja.

Posicionar el aparato de manera segura sobre las asas delanteras, antes de sacar los piés de la pared posterior y entonces sacar la caja. De esta manera evitarán el riesgo de daños en personas y daños en el aparato.

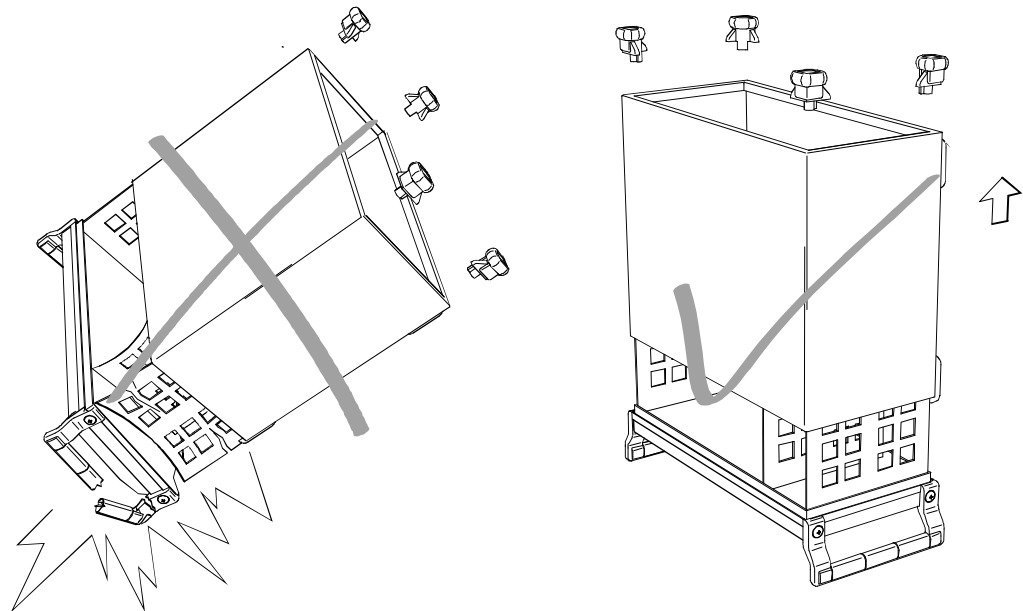

Existe el riesgo de heridas en el momento de poner otra vez la caja, como por ejemplo posiblemente engancharse los dedos. Por favor tengan además en cuenta de que no se enganchen o desconecten cables. Por favor atornillen los piés de la pared posterior directamente despues de poner la caja. No muevan el aparato nunca sin que los piés de la pared posterior estén atornillados.

Procedure in Case of Service and Ordering of Spare Parts

This section contains information on shipping an instrument to your service center and ordering spare parts.

Please contact your local Rohde & Schwarz service center if you need service or repair work of your equipment or to order spare parts. You can find the current address of your representative on our homepage www.rohde-schwarz.com.

Shipping the Instrument

We require the following information in order to answer your inquiry fast and correctly and to determine whether the warranty is still valid for your instrument:

- Instrument model
- Serial number
- Firmware version
- Must the instrument be returned with this firmware?
- Detailed error description in case of repair
- Indication of desired calibration
- Contact person for possible questions

In some countries, an RMA process is available for the return shipment of the instrument. For details, contact your local representative.

When shipping the instrument, be careful to provide for sufficient mechanical and antistatic protection.

- Use the original packaging for transporting or shipping the instrument. The protective caps for the front and rear prevent damage to the operating elements and the connectors.
- If you do not use the original packaging, provide for sufficient padding to prevent the instrument from slipping inside the box. Wrap antistatic packing foil around the instrument to protect it from electrostatic charging.

Rohde & Schwarz offers repair and calibrations of the test systems it produces. The calibration documentation fulfills ISO 17025 requirements.

Shipping Defective Modules

Also when shipping a module, be careful to provide for sufficient mechanical and antistatic protection.

- Ship the module in a sturdy, padded box.
- Wrap the module in antistatic foil.

If the packaging is only antistatic but not conductive, additional conductive packaging is required. The additional packaging is not required if the tightly fitting packaging is conductive.

Exception:

If the module contains a battery, the tightly fitting packaging must always consist of antistatic, non-chargeable material to protect the battery from being discharged.

Ordering Spare Parts

To deliver spare parts promptly and correctly, we need the following information:

- Stock number (see list of spare parts in chapter "Documents")
- Designation
- Component number according to list of spare parts
- Number of pieces
- Instrument type for which the spare part is needed
- Instrument stock number
- Instrument serial number
- Contact person for possible questions

Refurbished Modules

Refurbished modules are an economical alternative to original modules. Bear in mind that refurbished modules are not new, but repaired and fully tested parts. They may have traces from use, but they are electrically and mechanically equivalent to new modules.

Your Rohde & Schwarz representative will be happy to inform you about which modules are available as refurbished modules.

Taking Back Defective Replaced Modules

Defective modules of the replacement program which cannot be repaired are taken back within three months following delivery. A repurchasing value is credited.

Excluded are parts which cannot be repaired, e.g. printed boards that are burnt, broken or damaged by attempts to repair them, incomplete modules, and parts with severe mechanical damage.

Please return the defective replacement modules, together with the accompanying document for returned merchandise, which you received with the spare module. We need the following information:

- Stock number, serial number and designation of the removed part
- Detailed error description
- Stock number, serial number and type of instrument from which the module was removed
- Date of removal
- Name of the engineer/technician who replaced the module
- R&S ordering number
- Service reference number (if available)

Index

A

Adjustments	2.1
Amplitude modulation	
Test procedure	1.30, 1.35

B

Boot problems	
Troubleshooting	3.15

C

Check	
Rated characteristics	1.1
Check Front Panel	3.16

D

Debug Page	3.18
Documents	5.1

E

Error vector	
Test procedure	1.49
External level correction	2.3

F

Fan does not work	3.14
Firmware update	4.1
Frequency	
Test procedure	1.9
Frequency Error	3.39, 3.46
Fuses	3.52

I

I/Q imbalance	
Test procedure	1.51
I/Q modulation	
Test assembly	1.6
Test procedure	1.47
Internal Adjustments	3.21

L

Level	
Test procedure	1.24
Lithium Battery	2.3

M

Measuring equipment	
troubleshooting	3.11
Modulation	
Analog	
Test assembly	1.3
Modulation generator	
Test procedure	1.28
Module replacement	3.47
Modules overview	3.48

N

No baseband signal	3.44
--------------------------	------

O

Option	
Installation	4.5
List	4.5
Output impedance	
Test assembly	1.5

P

Phase noise	
Test assembly	1.4
Power cables	5.2
Pulse modulation	
Test procedure	1.44, 1.73

R

Rated characteristics	
Checking	1.1
Test procedures	1.8
Reference frequency	
Test procedure	1.8
Replacement	
Module	3.47
Replacing Fuses	3.52
Residual	
AM	
Test assembly	1.4

S

Software update	4.1
Spectral purity	
Test procedure	1.13
Switch-on problems	3.12

T

Test assembly	1.3
Analog modulations	1.3
I/Q modulation	1.6
Output impedance	1.5
Residual AM	1.4
SSB phase noise	1.4
Test equipment	1.1
Test frequency (recommended)	1.7
Test Points	3.18
Test procedure	
Amplitude modulation	1.30, 1.35
Error vector	1.49
Frequency	1.9
I/Q imbalance	1.51
I/Q modulation	1.47
Level	1.24
Modulation generator	1.28
Pulse modulation	1.44, 1.73
Spectral purity	1.13
Test procedures	1.8
Troubleshooting	
Problems with booting	3.15
Switch-on problems	3.12
Test points and debug page	3.18
Troubleshooting – Internal Adjustments	3.21

U

Unit cannot be switched on	3.12
Universal Coder	3.10
Update of firmware	4.1
Update of software	4.1
USB Cable Test	3.16

Contents - Chapter 1 "Performance Test"

1 Checking the Rated Characteristics	1.1
Measuring Equipment and Accessories	1.1
Test Assemblies	1.3
Standard Test Assembly for Analog Modulations	1.3
Test Assembly for Pulse Modulation	1.3
Test Assembly for Residual AM	1.4
Test Assembly for SSB Phase Noise and Jitter	1.4
Test Assembly for Output Impedance (VSWR)	1.5
Test Assembly for Setting Time	1.5
Test Assembly for I/Q Modulation	1.6
Preparation, Recommended Test Frequencies and Levels	1.7
Test Procedures	1.8
Reference Frequency	1.8
Output of Internal Reference	1.8
Input for External Reference	1.8
Frequency	1.9
Frequency Setting	1.9
Setting Time	1.9
Spectral Purity	1.13
Harmonics	1.13
Nonharmonics	1.14
Non-systematic nonharmonics	1.15
Wideband Noise	1.16
SSB Phase Noise	1.18
Residual FM	1.20
Residual AM	1.22
Level Data	1.24
Level Uncertainty	1.24
Output Impedance	1.26
Setting Time	1.27
Internal Modulation Generator	1.28
Amplitude Modulation	1.30
AM Setting Uncertainty	1.30
AM Distortion	1.32
AM Frequency Response	1.33
Synchronous PhiM with AM	1.34
Frequency Modulation	1.35
Test Methods	1.35
FM Setting Uncertainty	1.35
FM Distortion	1.36
FM Frequency Response	1.37
Synchronous AM with FM	1.39
Carrier Frequency Offset with FM	1.40
Phase Modulation	1.41
PhiM Setting Uncertainty	1.41
PhiM Distortion	1.42
PhiM Frequency Response	1.43

Pulse Modulation	1.44
ON/OFF Ratio	1.44
Rise/ Fall Time	1.45
Video Crosstalk	1.46
Pulse Generator	1.46
PULSE VIDEO	1.46
I/Q modulation	1.47
Input Impedance (VSWR).....	1.47
RF Frequency Response due to Modulation.....	1.48
Error Vector.....	1.49
Residual Carrier and Leakage	1.50
I/Q Imbalance.....	1.51
Image Rejection	1.52
Adjacent Channel Power for 3GPP FDD	1.53
Internal Baseband Generator	1.54
Modulated RF Frequency Response over the Complete Unit	1.54
Image Rejection over the Complete Unit	1.55
IQ Output.....	1.56
IQ Output, Frequency Response and Imbalance.....	1.56
IQ Output, Offset, Wideband Noise	1.57
IQ Output, Spurious Free Dynamic Range (SFDR)	1.58
Aliasing Filter – D/A Converter, Interpolation Spectra.....	1.59
Bias voltage (only for BBGEN Board Revision \geq 05.00)	1.61
Offset voltage (only for BBGEN Board Revision \geq 05.00)	1.61
Function External Clock	1.62
Function Level Attenuation.....	1.64
BNC Connectors	1.65
DIGITAL IQ IN/OUT Connector	1.65
GSM and GSM Normal Burst.....	1.66
GSM Edge and GSM Edge Burst.....	1.68
Modulation error for WCDMA - 3GPP	1.70
Digital Standards	1.71
GPS (R&S SMBV-K44).....	1.71
3GPP FDD HSUPA (R&S SMBV-K45).....	1.71
CDMA2000 (R&S SMBV-K46).....	1.71
WLAN 802.11 a, b, g (R&S SMBV-K48).....	1.71
WiMAX 802.16-2004 (R&S SMBV-K49).....	1.71
TD-SCDMA (R&S SMBV-K50)	1.71
TD-SCDMA enhanced BS/MS Tests (R&S SMBV-K51).....	1.71
Additive White Gaussian Noise (R&S SMBV-K62)	1.72
Hardware Signals	1.73
SIGNAL VALID.....	1.73
Phase Coherence (Option R&S SMBV-B90)	1.74

1 Checking the Rated Characteristics

This performance test describes the steps for testing the R&S SMB Signal Generator family and the installed options with respect to function and compliance with specifications.

In the following, the term DUT (Device under Test) is used for any signal generator of this family. The tests to be performed depend on the installed options. The values are given in the data sheet of the respective instrument.

Measuring Equipment and Accessories

Table 1-1 Measuring equipment and accessories

Item	Type of Instrument	Required Characteristics	Suitable Instrument	R&S Order No.
1	Frequency counter	1 Hz to RF_{max} , resolution 0.1 Hz (included in spectrum analyzer item 19)		
2	Reference source for SSB noise measurements	Identical generator as DUT or generator with at least 10 dB lower SSB noise as DUT Frequency range up to RF_{max}	R&S SMB100A with suited frequency option Reference Synthesizer or R&S SMA100A with option R&S SMA-B106 or R&S SMU200A with option R&S SMU-B106	1407.6004.02 1158.2878 1400.0000.02 1405.0809.02 1142.2005.02 1141.8803.02
4	Controller	Industry standard PC/XT/AT with IEC-60625 interface and USB interface		
5	Signal generator	0.1 MHz to RF_{max}	R&S SMBV100A with option R&S SMBV-B106 or R&S SMBV-B103 and R&S SMBV-B10 or R&S SMBV-B50 or R&S SMBV-B51 R&S SMU with options R&S SMU-B106, -B10, -B31	1407.6004.02 1407.9703.02 1407.9706.02 1407.8607.02 1407.8907.02 1407.9003.02 1141.2005.02
6	Phase noise test assembly	Phase Noise Test Set or Mixer: 10 MHz to RF_{max} , branching filter 20 MHz, DC decoupling after the mixer	R&S FSUP 8 or R&S FSU or R&S FSQ with phase noise measurement option Mixer: f < 1 GHz: Minicircuits ZFM2H 1 GHz < f < 6 GHz: Miteq DB0118LA2 Preamplifier: based on ADI AD829	1166.3506.08
7	Oscilloscope	Bandwidth \geq 100 MHz, two channels with DC coupling	Hameg HM1500-2 or similar	
8	RF power meter	9 kHz to RF_{max}	R&S NRP with R&S NRP-Z91 R&S NRP-Z51 or R&S NRVD with R&S NRV-Z5 R&S NRV-Z51	1143.8500.02 1168.8004.02 1138.0005.02 0857.8008.02 0828.3818.02 0857.9004.02
9	Low-noise preamplifier	9 kHz to 1 MHz gain > 20 dB, input noise < 4 nV (1 Hz)	based an ADI AD829	

Item	Type of Instrument	Required Characteristics	Suitable Instrument	R&S Order No.
10	VSWR bridge	100 MHz to RF _{max} directivity > 30 dB	f < 4 GHz: R&S ZRC or 2 GHz f < 6 GHz: Agilent 773D	1039.9492.55
12	RF power amplifier	10 MHz to RF _{max} , power > 33 dBm	Mini Circuits ZHL-03-5WF	
13	Pulse generator	Pulse repetition frequency at least 10 kHz	R&S SMBV100A equipped with option R&S SMBV K23 or R&S SMA100A	1406.6000.02
14	Arbitrary wave generator	two channels	included in R&S SMBV100A (item 5)	
15	AC/DC voltmeter	10 Hz to 10 MHz	R&S URE3	350.5315.03
16	Broadband FM demodulator	included in spectrum analyzer (item 19)		
17	RF attenuator	DC to RF _{max} , 10 dB, system N	R&S DNF	0272.4210.50
18	RF attenuator	DC to RF _{max} , 3 dB, system N	R&S DNF	0272.4010.50
19	RF analyzer & Demodulator for analog modulations & FM-demodulator	9 kHz to RF _{max} * 3	R&S FSMR26 with options R&S FSU-B25 R&S FS-B223 or R&S FSQ26 with options R&S FSU-B25 R&S FSQ K7	1166.3311.26 1044.9298.02 1157.1955.26 1155.5001.26 1044.9298.02 1141.1796.02
20	Program for simulation of digital modulations	Generation of data for ARB generator	R&S WinIQSIM, included in item 5	
21	Feed-through termination	50 Ω, BNC system	R&S RAD	0289.8966.00
22	Zero Bias Schottky Detecor	50 Ω	Krytar 202S	
23	DX DIGITAL I/Q CABLE	TVR290 Digital Interface Connection Cable (26 pin Mini D Ribbon Cable 14526-EZHB-XXX- 0QC)		1402.4990.00

Test Assemblies

Standard Test Assembly for Analog Modulations

<p>Test equipment</p>	<ul style="list-style-type: none"> - RF analyzer (Table 1-1, item 19) - Signal generator (Table 1-1, item 5)
<p>Test setup</p>	<p>The RF analyzer is used as a modulation analyzer. The signal generator is used as modulation source in case of external modulation.</p>

Test Assembly for Pulse Modulation

<p>Test equipment</p>	<ul style="list-style-type: none"> - Oscilloscope (Table 1-1, item 7) - Signal generator (Table 1-1, item 5) - Mixer
<p>Test setup</p>	<p>The pulsed RF is mixed down to DC in phase and analyzed with an oscilloscope.</p>

Test Assembly for Residual AM

Test equipment	<ul style="list-style-type: none"> - RF analyzer (Table 1-1, item 19) - Zero Bias Schottky Detector (Table 1-1, item 22) - Low Noise Preamplifier 10 Hz – 30kHz, >30dB Gain (Table 1-1, item 9)
Test setup	<p>The diagram shows a DUT (Device Under Test) and an RF Analyzer. A 10 MHz reference signal is connected to both. The RF output from the DUT is sent to a Detector, then a Preamplifier, and finally to the RF Analyzer.</p>

Test Assembly for SSB Phase Noise and Jitter

Test equipment	<ul style="list-style-type: none"> - SSB reference source (Table 1-1 item 2), - Phase noise test assembly - Spectrum analyzer (Table 1-1 item 19)
Test setup	<p>The diagram shows a Reference source and a DUT. A 10 MHz reference signal is connected to both. The Reference source is connected to a LO Mixer. The DUT's RF output is also connected to the LO Mixer. The LO Mixer has LO, Mixer, RF, and IF ports. The RF output from the DUT and the IF output from the LO Mixer are connected to an RF Analyzer.</p>

Test Assembly for Output Impedance (VSWR)

<p>Test equipment</p>	<ul style="list-style-type: none"> - VSWR bridge (Table 1-1, item 10), - Second signal generator (Table 1-1, item 5) - Spectrum analyzer (Table 1-1, item 19)
<p>Test setup</p>	
	<p>Note: <i>The INPUT of the directional coupler is directly screwed to the DUT. The second signal generator is connected to the line connector (OUTPUT), the analyzer to the coupling output (COUPLED) of the directional coupler.</i></p>

Test Assembly for Setting Time

<p>Test equipment</p>	<ul style="list-style-type: none"> - Spectrum analyzer (Table 1-1, item 19) - Pulse generator (Table 1-1, item 13)
<p>Test setup</p>	

Test Assembly for I/Q Modulation

<p>Test equipment</p>	<ul style="list-style-type: none"> ➤ - Demodulator for digital modulation (<i>Table 1-1</i>, item 19) ➤ - Arbitrary waveform generator (<i>Table 1-1</i>, item 14) ➤ - Program for simulation of digital modulations (<i>Table 1-1</i>, item 20) ➤ - Controller to industry standard (<i>Table 1-1</i>, item 4)
<p>Test setup</p>	<p>The diagram illustrates the test setup for I/Q modulation. It features a central Device Under Test (DUT) with a control panel. To its right, an ARB generator provides I and Q signals to the DUT. Below the DUT, an RF analyzer (digital demodulation) provides a 10 MHz reference signal to the DUT and receives an RF signal from the DUT. A Processor is connected to the ARB generator via a IEEE(IEC) Bus.</p>

Preparation, Recommended Test Frequencies and Levels

To ensure proper conditions for the performance test and prevent setting errors, the instrument must be prepared as follows:

- Allow for a minimum **warm-up time of 30 minutes** at ambient temperature.
- Carry out all **internal adjustments** (see operating manual, chapter 4, section "Internal Adjustment - Setup-System").
- Press **[PRESET]** to establish a defined **initial** state before configuring a new measurement.

The following sections describe the **procedures** for checking the rated values. The **values** are specified in the **data sheet**. Additional uncertainties introduced by the measurement equipment must be taken into account when checking the rated values.

The following table lists the important internal switch point frequencies and the recommended measurement frequencies derived from these frequencies. We recommend measurements at these frequencies unless particular test frequencies are specified. In the following, RF_{max} is the maximal settable RF (depending on installed options).

Table 1-2 Range limits, main test frequencies for CW Mode

Range	Frequency	Hardware switching points	Recommended test frequencies
Direct DDS Synthesis	$9 \text{ kHz} \leq f \leq 23.4375 \text{ MHz}$	-	9 kHz; 200 kHz; 1 MHz; 5 MHz; 10 MHz; 23.4375 MHz
Divider/128	$23.4375 \text{ MHz} < f \leq 46.875 \text{ MHz}$	-	23.438 MHz; 46.875 MHz
Divider /64	$46.875 \text{ MHz} < f \leq 93.75 \text{ MHz}$	47MHz; 66MHz	46.885 MHz; 65.9 MHz; 93.75 MHz
Divider /32	$93.75 \text{ MHz} < f \leq 187.5 \text{ MHz}$	94 MHz; 144 MHz; 187 MHz	93.76 MHz; 143.9 MHz; 186.9 MHz
Divider /16	$187.5 \text{ MHz} < f \leq 375 \text{ MHz}$	265 MHz; 375MHz	187.6 MHz; 264.9 MHz; 374.9 MHz
Divider /8	$375 \text{ MHz} < f \leq 750 \text{ MHz}$	530MHz; 750MHz	375.1 MHz; 529.9 MHz; 749.9 MHz
Divider /4	$750 \text{ MHz} < f \leq 1500 \text{ MHz}$	1060MHz; 1500 MHz	750.1 MHz; 1059.9 MHz; 1100 MHz; 1499.9 MHz
Divider /2	$1500 \text{ MHz} < f \leq 3 \text{ GHz}$	2121 MHz; 3000 MHz	1500.1 MHz; 2120.9 MHz; 2200 MHz; 2999.9 MHz
Base octave	$3 \text{ GHz} < f \leq 6 \text{ GHz}$	4242 MHz	3000.1 MHz; 3200 MHz; 4241.9 MHz; 5 GHz; 6 GHz

RF_{max} is the maximum output frequency of the instrument according to its frequency option (1.1 GHz, 2.2 GHz, 3.2 GHz or 6 GHz).

For **high-resolution measurements** in the entire frequency range, a logarithmic frequency grid in 1-2-5 sequence is recommended up to 50 MHz; above this value, linear 50 MHz steps should be used up to the upper limit frequency.

The recommended **test levels** are at the upper and lower switching threshold of the attenuator. The electronic attenuator of the DUT is switched depending on frequency, modulation parameters and level according to an internal stored table in approximately 5 dB steps. The switching thresholds can be detected under **Attenuator fixed range** in the **Level** menu. After setting all other parameters, the threshold level can be detected by level variation. The level at which the attenuator fixed range changes is the threshold. By measuring at the last level setting of one range and the first level setting of the next range, the internal setting range borders are used. In the following, P_{min} is the lowest level before switching the attenuator, and P_{max} the highest

Test Procedures

Reference Frequency

Output of Internal Reference

Important: Allow the DUT to warm up for at least 2 hours before the measurement.

Test equipment	- Frequency counter (Table 1-1 , item 1)
Test setup	➤ Connect a calibrated frequency counter to the REF OUT output (on rear panel).
Measurement	➤ Measure the frequency. ⇒ The frequency deviation must not exceed the sum of deviations resulting from the frequency error in the rated temperature range and from aging.

Input for External Reference

Test equipment	- Frequency counter (Table 1-1 , item 1) - Signal generator (Table 1-1 , item 5)						
Test method	The external reference input frequency of the DUT is varied according to the data sheet and the RF output signal frequency is controlled with a frequency counter to follow this variation.						
Preparation of measurement	<ul style="list-style-type: none"> ➤ Connect the signal generator RF output to the REF IN input for the external reference (on rear panel) of the DUT. Connect a calibrated frequency counter to the RF output. Synchronize the signal generator and the frequency counter. ➤ Setting on DUT: <ul style="list-style-type: none"> - RF on - Level: 0 dBm (suitable level for the frequency counter) - Frequency: 1 GHz - Setup ⇒ Reference Oscillator ⇒ Source: External ➤ Setting on signal generator: <ul style="list-style-type: none"> - RF on - Level: 0 dBm 						
Measurement	<ul style="list-style-type: none"> ➤ Set the signal generator frequency to 9.99997 MHz and 10.0003 MHz. Measure the output frequency of the DUT. <table border="1" style="margin-left: auto; margin-right: auto;"> <tr> <td>Signal generator frequency</td> <td>9.99997 MHz</td> <td>10.0003 MHz</td> </tr> <tr> <td>DUT frequency</td> <td>999.997 MHz</td> <td>1000.03 MHz</td> </tr> </table> <p>There must be no relative frequency error and no error message in the display of the DUT.</p>	Signal generator frequency	9.99997 MHz	10.0003 MHz	DUT frequency	999.997 MHz	1000.03 MHz
Signal generator frequency	9.99997 MHz	10.0003 MHz					
DUT frequency	999.997 MHz	1000.03 MHz					

Frequency

Frequency Setting

Test equipment	- Frequency counter (Table 1-1 , item 1)
Test method	The frequency setting is checked by running the internal synthesizer adjustments to check the frequency overlap of the VCOs
Measurement	➤ Run: Setup ⇨ Internal Adjustments ⇨ Adjust Synthesis There must be no error message.

Setting Time

Test assembly	See section " Test Assembly for Setting Time ", page 1.5 . For measuring after IEC/IEEE bus delimiter the EOI-line of the IEC/IEEE bus is used as trigger signal instead of the pulse generator.
Test method	The spectrum analyzer operates as an FM demodulator. A controller transmits the start and the stop frequency via the IEC/IEEE bus. The analyzer is triggered by the positive edge on the EOI line of the IEC/IEEE bus or the trigger pulse in list mode. At switch over from start to stop frequency, the settling procedure is displayed on the screen of the analyzer.
Preparation of measurement	<ul style="list-style-type: none"> ➤ Synchronize the reference frequencies of the DUT and the analyzer. ➤ Make IEC/IEEE bus and RF connections. ➤ Connect spectrum analyzers trigger connector to EOI line (pin 5) of IEC/IEEE bus. ➤ Settings on DUT: <ul style="list-style-type: none"> - Frequency: start frequency unmodulated, - Level: 0 dBm ➤ Settings on spectrum analyzer: <ul style="list-style-type: none"> - AMPT/REF LEVEL 0 dBm - FREQ/CENTER/STOP FREQUENCY - FM DEMOD ON - DEMOD BW 50 kHz - RANGE /DEVIATION PER DIV 200 Hz - MEAS TIME 10 ms - TRIGGER EXTERN - External triggering by positive edge at 1.4 V.

<p>Measurement</p>	<ul style="list-style-type: none"> ➤ Settings on analyzer: - Set the analyzer to the stop frequency ➤ Set the DUT to the start frequency f_{start} ➤ Send the stop frequency f_{stop} from the controller to the DUT. <ul style="list-style-type: none"> ⇒ The externally triggered analyzer displays the settling curve. The setting time is defined as the time from which on the frequency deviation from the stop frequency is less than the specified deviation in the data sheet. ➤ Repeat the measurement with ALC state Off: <ul style="list-style-type: none"> ⇒ RF ⇒ Automatic Level Control ⇒ State ⇒ OFF (Sample & Hold) ➤ Switch on IQ-Modulation: <ul style="list-style-type: none"> I/Q Settings menu: Source Analog Wideband I/Q Input State On and supply 0.5 V DC to the I_{ext} Input Repeat the measurement with <ul style="list-style-type: none"> ⇒ RF ⇒ Automatic Level Control ⇒ ALC state on, ⇒ RF ⇒ Automatic Level Control ⇒ ALC state Off (Sample & Hold) and with <ul style="list-style-type: none"> ⇒ RF ⇒ Automatic Level Control ⇒ ALC state Off (Table)
<p>Measurements in List mode</p>	<ul style="list-style-type: none"> ➤ Connect a trigger source (digital voltage levels: $U1 < 0.8\text{ V}$ and $U2 > 2\text{ V}$) to the INSTR TRIG connector of DUT and analyzer. The pulse generator can be used as trigger source for example. ➤ Settings on DUT: <ul style="list-style-type: none"> - In the List mode menu, generate a list containing the two test frequencies f_{start} and f_{stop} with a level of 0 dBm each. - Set operating mode to External Step. ➤ Settings on spectrum analyzer: <ul style="list-style-type: none"> - Set DEMOD BW to 200 kHz - Set MEAS TIME to 2 ms ➤ Toggle the output voltage of the trigger source. (Settings on pulse generator: single shot) ➤ With each rising edge from the trigger source the frequency toggles between f_{start} and f_{stop}. <ul style="list-style-type: none"> ⇒ The externally triggered analyzer displays the settling curve. The setting time is defined as the time when the frequency deviation from the stop frequency is less than the specified deviation in the data sheet. ➤ Repeat the measurement with IQ-Modulation switched on: <ul style="list-style-type: none"> I/Q Settings menu: Source Analog Wideband I/Q Input State On and supply 0.5 V DC to the I_{ext} Input

Recommended test frequencies

f_{start}	f_{stop}	Deviation
23.4 MHz	1100 MHz	±110 Hz
46.8 MHz	46.9 MHz	±20 Hz
46.9 MHz	46.8 MHz	±20 Hz
93.7 MHz	93.8 MHz	±20 Hz
93.8 MHz	93.7 MHz	±20 Hz
187.4 MHz	187.6 MHz	±20 Hz
187.6 MHz	187.4 MHz	±20 Hz
374.9 MHz	375.1 MHz	±37.5 Hz
375.1 MHz	374.9 MHz	±37.5 Hz
749.9 MHz	750.1 MHz	±75 Hz
750.1 MHz	749.9 MHz	±75 Hz
1499.9 MHz	1500.1 MHz	±150 Hz
1500.1 MHz	1499.9 MHz	±150 Hz
2999.9 MHz	3000.1 MHz	±300 Hz
3000.1 MHz	2999.9 MHz	±300 Hz
3000.1 MHz	6000 MHz	±600 Hz
6000 MHz	3000.1 MHz	±300 Hz

Example of Measurement:

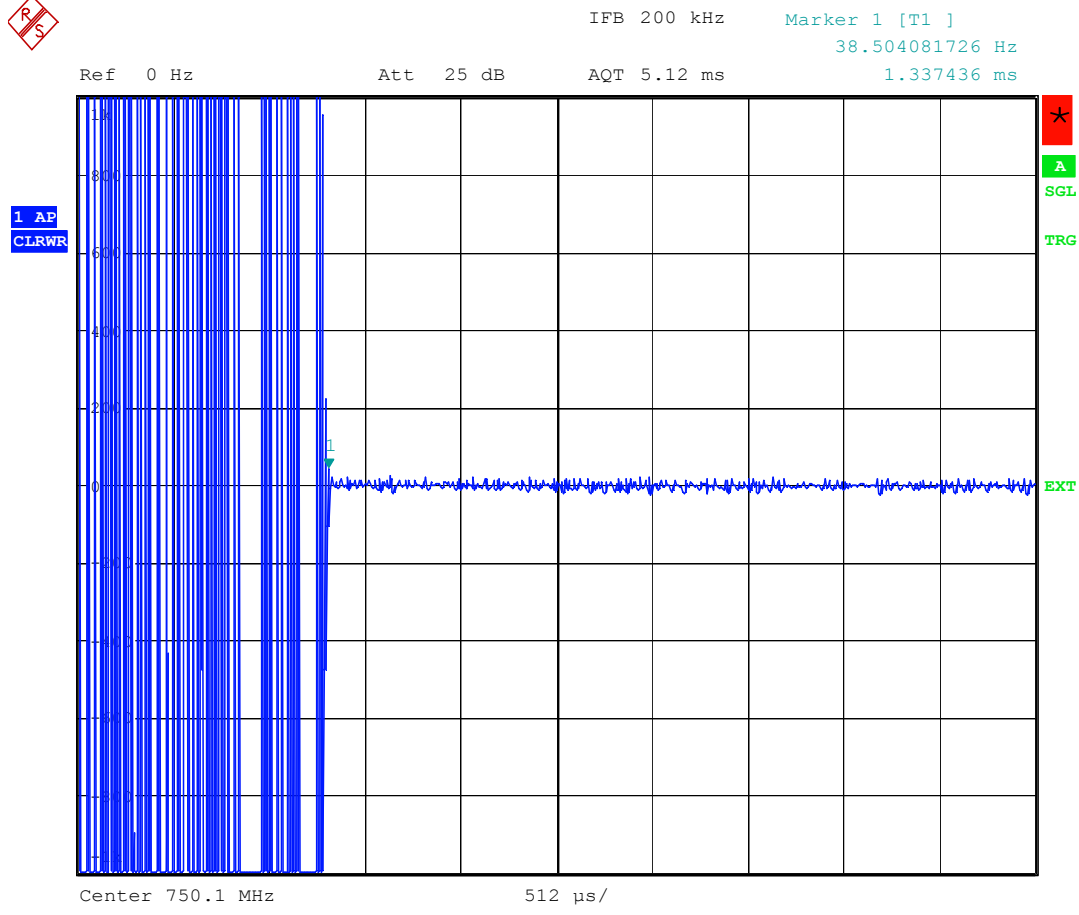

Date: 14.FEB.2008 18:58:23

The marker is set to the time when the trace enters the specified interval of 750.1 MHz ± 75 Hz. The setting time is 1.34 ms.

Spectral Purity

Harmonics

Test equipment	Spectrum analyzer (Table 1-1 , item 19)
Test setup	<ul style="list-style-type: none"> ➤ Connect the spectrum analyzer to the RF output of the DUT. ➤ Synchronize the reference frequencies of analyzer and DUT.
Measurement	<ul style="list-style-type: none"> ➤ Settings on analyzer: Reference level = 20 dBm, 10 dB/div. Span 0 Hz, Resolution bandwidth 10 kHz ➤ Settings on DUT: - Frequency: test frequencies, unmodulated - Level: test levels ➤ First measure the level of the fundamental P_f at the test frequency f as a reference. Then measure the signal levels P_{2*f} and P_{3*f} at twice and three times the carrier frequency f. ⇒ The harmonic spacing is the measured harmonic level referred to the fundamental: HD2 = $P_f - P_{2*f}$ HD3 = $P_f - P_{3*f}$ (in dBc = referred to the carrier)
Recommended test frequencies and levels	<p>Test frequencies: 1 MHz, 5 MHz, 10 MHz, 23.4375 MHz, 23.438 MHz, 46.875 MHz, 46.885 MHz, 65.9 MHz, 66.1 MHz, 93.75 MHz, 93.76 MHz, 143.9 MHz, 186.9 MHz, 187.6 MHz, 264.9 MHz, 374.9 MHz, 375.1 MHz, 529.9 MHz, 530.1 MHz, 749.9 MHz, 750.1 MHz, 1059.9 MHz, 1060.1 MHz, 1100 MHz, 1499.9 MHz, 1500.1 MHz, 2120.9 MHz, 2121.1 MHz, 2200 MHz, 2999.9 MHz, 3000.1 MHz, 3200 MHz, 4241.9 MHz, 4242.1 MHz, 5 GHz, 6 GHz</p> <p>Test level: +8dBm</p>

Nonharmonics

Test equipment	Same as for harmonics
Test setup	Same as for harmonics
Measurement	<ul style="list-style-type: none"> ➤ Setting on analyzer: Reference level = 0 dBm, 10 dB/div. Span 50 Hz, Resolution bandwidth 10 Hz ➤ Setting on DUT Level = 0 dBm ➤ First the carrier level P_f is measured at the test frequency f as reference and then the signal level P_{search} is measured at the analyzer search frequency. <ul style="list-style-type: none"> ⇒ The nonharmonic spacing D is the measured level referred to the reference level: $D = P_f - P_{search}$ (in dBc = referred to the carrier)
	<p>Note: <i>Some of the nonharmonics suppression values measured might be outside the analyzer specifications. In case of doubt, repeat the measurement with a 3 dB attenuator at the analyzer input. If the nonharmonic spacing changes the nonharmonic is due to the analyzer.</i></p> <p>Alternative: <i>Check with a second source with differing synthesizer architecture (not a R&S SMB)</i></p>

Recommended settings and search frequencies:

DUT Frequency	Analyzer search frequency
13 MHz	9 MHz
13 MHz	22 MHz
17 MHz	15 MHz
23.4375 MHz	6.25 MHz
23.4375 MHz	29.6875 MHz
511.2 MHz	511.392 MHz
1050.1 MHz	1050.15714 MHz
1100.01 MHz	1100.02 MHz
2045 MHz	2045.133329 MHz
4086 MHz	4086.72 MHz
4289.8 MHz	4293.42975 MHz
4521.6 MHz	4522.351807 MHz
4745 MHz	4745.05747 MHz
5180 MHz	5184.473684 MHz

Repeat the measurement with IQ-Modulation switched on:

I/Q Settings menu:

Source Analog Wideband I/Q Input

State On

and supply 0.5 V DC to the I_{ext} Input

DUT Frequency	Analyzer search frequency
101 MHz	200 MHz
101 MHz	1200 MHz
101 MHz	1301 MHz
2200 MHz	200 MHz
2200 MHz	600 MHz
2200 MHz	1000 MHz
2200 MHz	1200 MHz
2200 MHz	2400 MHz
2200 MHz	3600 MHz

Non-systematic nonharmonics

<p>Measurement</p>	<ul style="list-style-type: none"> ➤ Settings on DUT: <ul style="list-style-type: none"> - Test frequencies: 34 MHz, 65.9 MHz, 100 MHz, 143.9 MHz, 264.8 MHz, 529.9 MHz, 1059.9 MHz, 2120.9 MHz, 3000 MHz, 4241.9 MHz - Test level 0dBm unmodulated ➤ Recommended settings on analyzer: <ul style="list-style-type: none"> - Max peak detector - Filter Type: FFT - Ref-Level 0 dBm ➤ - Set analyzer center frequency to the test frequency, span to 40 MHz and resolution bandwidth to 2 kHz <ul style="list-style-type: none"> - Measure carrier level P - all signals other than the carrier must be below P – 70 dB - Set analyzer span to 100 kHz and resolution bandwidth to 200 Hz <ul style="list-style-type: none"> - all signals other than the carrier must be below P – 70 dB ➤ Repeat the measurement at 1 GHz with IQ-Modulation switched on: I/Q Settings menu: Source Analog Wideband I/Q Input State On and supply 0.5 V DC to the I_{ext} Input
	<p>Note: <i>Some of the nonharmonics suppression values to be measured might be outside analyzer specifications. In case of doubt, repeat the measurement with a 3 dB attenuator pad at the analyzer input. If the nonharmonics suppression changes the nonharmonics are due to the analyzer. Because of the bell-shaped noise of the analyzer near the carrier, smaller resolution bandwidths may have to be used. To exclude amplitude independent nonharmonics of the analyzer, use a second generator with different synthesis architecture.</i></p>

Wideband Noise

Test assembly	Connect spectrum analyzer to RF socket of the DUT.
Test method	The carrier power is measured first. Then the center frequency of the analyzer is increased by 10 MHz and the noise power in a small bandwidth is measured. The difference of the carrier power and the noise power in 1 Hz bandwidth, which is calculated from the measurement, is defined as wideband noise. Because wideband noise degrades with lower electronic levels in front of the output step attenuator the output level of the generator has to be set to the lowest level before switching the step attenuator.
Measurement	<ul style="list-style-type: none"> ➤ Settings on DUT: <ul style="list-style-type: none"> - frequency: test frequency - Level: 0 dBm - determine Att-fixed range upper Level P_{upper}: - \Rightarrow RF \Rightarrow Level \Rightarrow Att fixed range \Rightarrow upper - set level to $P_{upper} + 0.1$ dB ➤ Settings on analyzer: <ul style="list-style-type: none"> - center: test frequency - reference level $P_{upper} + 1$ dB - Attenuator $D_{min} = P_{upper} - P_{1dBm} + 5dB \Rightarrow$ round to next larger available Attenuation of the analyzer ($P_{1dBm} =$ analyzer P1dB level at test frequency) - span 110 kHz - Detector RMS - Sweep Time Manual 1s - switch on channel power measurement with 100 kHz bandwidth ➤ Determine the channel power with the center frequency of the analyzer set to the test frequency and note it down as P_{ref}. ➤ Increase the analyzer center frequency by 9.9 MHz. ➤ Inhibit the switching of the attenuator with AMPT RF ATTEN MANUAL without entering a value so that the input mixer is not overdriven. ➤ Lower the reference level of the analyzer by 20 dB, read the new channel power P_{noise}. ➤ Minimize the output level on the DUT by means of RF OFF, read the channel power P_{res}.

<p>Evaluation</p>	<ul style="list-style-type: none"> ➤ If the power $P_{res} < P_{noise} - 0.41 \text{ dB}$ the inherent noise power of the analyzer can be subtracted: $W_{Noise} = -P_{ref} + 10 * \log_{10}(10^{P_{noise}/10} - 10^{P_{res}/10}) - 50 \text{ dB}$ ➤ If the power $P_{res} > P_{noise} - 0.41 \text{ dB}$ the analyzer resolution is not sufficient for a precise measurement. The true result is in such case certainly more than 10 dB below the measured value. The result than is at least: $W_{Noise} = -P_{ref} + P_{noise} - 50 \text{ dB} - 10 \text{ dB}$ <p>⇒ The difference between the (possibly corrected) power P_{noise} in dBm and the power P_{ref} in dBm is the broadband noise floor in dBc.</p>
<ul style="list-style-type: none"> ➤ Recommended test frequencies 	<ul style="list-style-type: none"> ➤ 1.02 MHz, 10.1 MHz, 23.4375 MHz, 23.438 MHz, 46.875 MHz, 46.885 MHz, 65.9 MHz, 66.1 MHz, 93.75 MHz, 93.76 MHz, 143.9 MHz, 186.9 MHz, 187.6 MHz, 264.9 MHz, 374.9 MHz, 375.1 MHz, 529.9 MHz, 530.1 MHz, 749.9 MHz, 750.1 MHz, 1059.9 MHz, 1060.1 MHz, 1100 MHz, 1499.9 MHz, 1500.1 MHz, 2120.9 MHz, 2121.1 MHz, 2200 MHz, 2999.9 MHz, 3000.1 MHz, 3200 MHz, 4241.9 MHz, 4242.1 MHz, 5 GHz, 6 GHz

SSB Phase Noise

The SSB phase noise of the DUT can be measured direct if a Phase Noise Test Set is available. An R&S FSUP or any other analyzer with phase noise option is suitable if its own phase noise is at least 6 dB less than the guaranteed DUT Phase noise in the data sheet.

Measurement: Set the Level of the DUT to 0 dBm and measure the phase noise at 20 kHz offset with the analyzer in phase noise mode.

If no suited analyzer is available, the Phase noise can be measured with the aid of a second generator and a mixer:

Test assembly	See section " Test Assembly for SSB Phase Noise and Jitter ", page 1.4.
Test method	The two generators are set to the test frequency and synchronized with a phase offset of 90° (phase quadrature). Mixing to 0 Hz suppresses the RF carrier. Due to the phase quadrature, the mixer supplies a voltage representing the phase difference between the input signals. This voltage is measured with the spectrum analyzer.
Measurement	<ul style="list-style-type: none"> ➤ Set the levels of the two generators in accordance with the specifications of the mixer used. (For the MITEQ-DB0118 mixer set the LO-level to +10 dBm and the RF-level to 0 dBm.) ➤ Settings of the DUT: <ul style="list-style-type: none"> - PM int - PM deviation 0.01 rad - Modulation frequency 19 kHz ➤ Settings on the analyzer: <ul style="list-style-type: none"> - Center frequency 19.5 kHz - Span 2 kHz - Input coupling DC - Attenuator manual 0 dB - average on, count = 10 - average mode: linear/ power - Filter Type: FFT - Resolution Bandwidth 10 Hz - set marker to 19 kHz. - set delta marker to 20 kHz ➤ Adjust the phase of the DUT for phase quadrature: Set the Delta Phase in the Frequency/Phase menu for maximum marker readout at 19 kHz in the Delta Phase range of 0° to 180°. Note down the relative Delta marker level D. ➤ Calculate the SSB phase noise in dbc/Hz: <ul style="list-style-type: none"> - The Delta Marker measures the noise in 10 Hz bandwidth. The power in 1 Hz bandwidth is one tenth of this power: $\log_{10}(10)$ - The PM with a modulation rate of 0.01 rad in baseband is equivalent to a phase noise of -46 dBc. - The phase noises of the two generators add together: - 3dB if they are of the same type. <p>If the reference generator is of the same type as the DUT: $PN = D - 10 * \log_{10}(10) - 46 \text{ dB} - 3 \text{ dB}$ PN = D - 59 dB</p> <p>If the phase noise of the reference generator is at least 10 dB better than the phase noise of the DUT: $PN = D - \log_{10}(10) - 46 \text{ dB}$ PN = D - 56 dB</p>

Residual FM

Test assembly	Connect spectrum analyzer to RF socket of the DUT.
Test method	The FM demodulator of the analyzer is used to FM-demodulate the CW signal of the DUT. By setting the AF-low-pass and high-pass-filters the RMS value in the desired bandwidth can be measured. The value displayed is the sum of the analyzer residual FM and the DUT residual FM. Because they are uncorrelated, the displayed result is worse than residual RMS of the DUT alone. Therefore, if the sum is in tolerance according to the data sheet the DUT is also in tolerance.
Measurement	<ul style="list-style-type: none"> ➤ Settings on DUT: <ul style="list-style-type: none"> - frequency: 1 GHz - Level: 0 dBm ➤ Settings on analyzer: <ul style="list-style-type: none"> - CENTER: 1 GHz - REFERENCE LEVEL: 1 dBm - FM DEMOD - FM DEMOD ⇨ MEAS TIME: 100ms - FM DEMOD ⇨ DEMOD BW: 200 kHz - FM DEMOD ⇨ AF-FILTER ⇨ HIGH PASS AF FILTER: 300 Hz - FM DEMOD ⇨ AF-FILTER ⇨ LOW PASS AF FILTER: 3 kHz ➤ The Residual FM in the frequency range 300 Hz – 3 kHz is the RMS value displayed. ➤ Repeat the measurement with setting the HIGH PASS AF FILTER: to 20 Hz and the LOW PASS AF FILTER to 23 kHz.

Example:

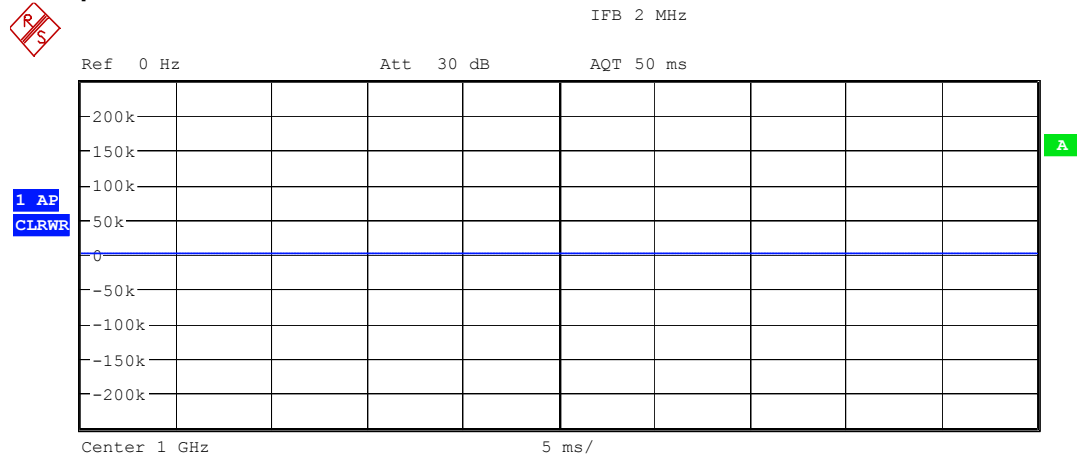

Frequency Modulation Summary

Coupling	DC		Carrier Offset	45.639 Hz
Deviation	+peak	12.93 Hz	Carrier Power	-0.91 dBm
	-peak	-12.41 Hz	Modulation Frequency	--- Hz
	±peak/2	12.67 Hz	Sampling Rate	250 kHz
	RMS	3.465 Hz	Record Length	12501
			Demod Bandwidth	200 kHz
			AF Filter	HP 20 Hz
				LP 23 kHz

Date: 22.FEB.2008 17:35:25

Residual FM = 3.465 Hz

Residual AM

Test assembly	Connect spectrum analyzer to RF socket of the DUT.
Test method	The FM demodulator of the analyzer is used to AM-demodulate the CW signal of the DUT. By setting the AF-low-pass and high-pass-filters the RMS value in the desired bandwidth can be measured. The value displayed is the sum of the analyzer residual AM and the DUT residual AM. Because they are uncorrelated, the displayed result is worse than residual RMS of the DUT alone. Therefore, if the sum is in tolerance according to the data sheet the DUT is also in tolerance.
Measurement	<ul style="list-style-type: none"> ➤ Settings on DUT: <ul style="list-style-type: none"> - frequency: 1 GHz - Level: 0 dBm ➤ Settings on analyzer: <ul style="list-style-type: none"> - CENTER: 1 GHz - REFERENCE LEVEL: 1 dBm - AMPT ⇒ RF ATTEN MANUAL: 10 dB - FM DEMOD - FM DEMOD ⇒ RESULT DISPLAY ⇒ AM - FM DEMOD ⇒ MEAS TIME: 100ms - FM DEMOD ⇒ DEMOD BW: 200 kHz - FM DEMOD ⇒ AF-FILTER ⇒ HIGH PASS AF FILTER: 20 Hz - FM DEMOD ⇒ AF-FILTER ⇒ LOW PASS AF FILTER: 20 kHz ➤ The Residual AM in the frequency range 20 Hz – 23 kHz is the RMS value displayed.
Test frequencies	5 MHz, 450 MHz, 1 GHz, 2.2 GHz, 3.2 GHz, 4.5 GHz, 6 GHz

Example:

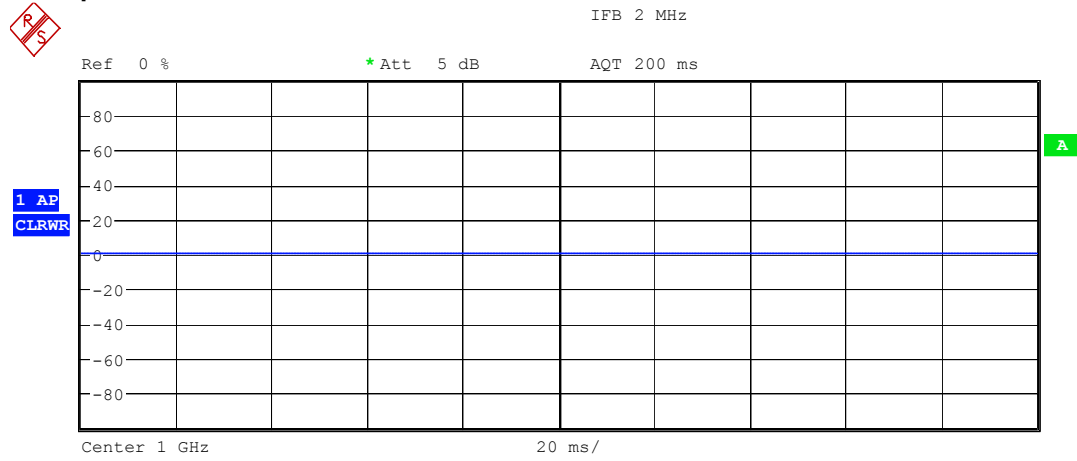

Amplitude Modulation Summary

Modulation Depth	0.022 %	Carrier Power	-0.87 dBm
Modulation +peak	0.022 %	Modulation Frequency	--- Hz
-peak	-0.023 %	Sampling Rate	250 kHz
±peak/2	0.022 %	Record Length	50001
RMS	0.005 %	Demod Bandwidth	200 kHz
		AF Filter	HP 20 Hz
			LP 23 kHz

Date: 25.FEB.2008 16:33:44

Residual AM = 0.005 %

Level Data

Level Uncertainty

Test method	The level uncertainty is measured in two steps. First, the frequency response is measured at a fixed level with high frequency resolution. Then the level dependant uncertainty is measured at fixed frequencies over the specified range.
Test equipment	<ul style="list-style-type: none"> - Power meter (Table 1-1, item 8) - Spectrum analyzer (Table 1-1, item 19) - Low-noise preamplifier (Table 1-1, item 9)

Test method for levels in measurement range of power meter

Test setup	Connect power meter to RF output socket.
Measurement	<ul style="list-style-type: none"> ➤ Setting on DUT: <ul style="list-style-type: none"> - Levels : +18 dBm in level Mode AUTO ➤ Measure the level $P_{absolute}$ at the recommended test frequencies up to RF_{max}. <ul style="list-style-type: none"> ⇒ The level error is the deviation of the measured level from the set value. ➤ Repeat this measurement at + 13 dBm in level Mode OFF (Sample & Hold) at 200 kHz, 25 MHz, 100 MHz, 1.1 GHz, 2.2 GHz, 3.2 GHz and 6 GHz ➤ Repeat the measurement with IQ-Modulation switched on: <ul style="list-style-type: none"> I/Q Settings menu: <ul style="list-style-type: none"> Source Analog Wideband I/Q Input State On supply 0.5 V DC to the I_{ext} Input Level 0 dBm Automatic Level Control menu <ul style="list-style-type: none"> State off ALC Off Mode Sample & Hold ➤ Repeat the measurement with <ul style="list-style-type: none"> Level 8 dBm ALC Off Mode Table
Recommended test frequencies for the level frequency response measurement	200 kHz, 500 kHz, 1 MHz; 5 MHz; 7.00000001 MHz; 10 MHz; 23.4375 MHz 25 MHz to 95 MHz in 10 MHz Steps 112.5 MHz to 6 GHz in 25 MHz Steps

Test method for low levels

Test principle	<p>Low levels can only be measured using a frequency selective measurement instrument. Spectrum analyzers with digital IF are best suited for this measurement due to their low linearity error. The absolute accuracy of these analyzers is not sufficient for this measurement. So a relative measurement referred to the measurements performed with the power meter is used to increase the accuracy of the measurement.</p> <p>Only by switching the input attenuator and preamplifier (when available) of the analyzer the needed dynamic range of more than 120 dB can be reached. After switching the analyzer attenuator or preamplifier, a continuity calibration is to be carried out. It is therefore recommended to switch the attenuator not until reaching 50 dB under full scale, since the linearity errors are very small in this range.</p>
Test setup	<ul style="list-style-type: none"> ➤ Connect the spectrum analyzer to the RF output of the DUT with hermetically sealed RF measurement cables.
Measurement	<ul style="list-style-type: none"> ➤ Settings on DUT <ul style="list-style-type: none"> Frequency recommended test frequencies Level +18 dBm, unmodulated ➤ Setting on the analyzer <ul style="list-style-type: none"> Test frequency SPAN 10 Hz FILTER TYPE FFT RES BW 5 Hz set Marker to test frequency Reference level $P_{ref} = +20$ dBm ➤ Read the marker level P_{Marker} and calculate the correction factor $C = P_{absolute} - P_{Marker}$ <ul style="list-style-type: none"> with $P_{absolute}$ from the measurements performed with the power meter. ➤ Now decrease the DUT level in 5 dB steps and calculate the output power P by adding the Correction factor C to the marker readout. ➤ As soon as the marker level P_{Att1} is lower than $P_{ref} - 45$ dB increase the sensitivity of the analyzer by reducing the input attenuation, switching on the internal preamplifier if available and reducing the resolution bandwidth to 1 Hz for levels below -90 dBm. Set the analyzer reference level to $P_{Att1} + 1$ dB. After switching the analyzer sensitivity read out the marker level P_{Att2} and recalculate the Correction factor: $C_{new} = C_{old} + P_{Att1} - P_{Att2}$ ➤ Continue the measurement down to -120 dBm in 5 dB steps.
Recommended test frequencies.	201 kHz, 512.5 MHz, 1087.5 MHz, 2187.5 MHz, 3187.5 MHz, 4012.5 MHz, 5012.5 MHz, 5987.5 MHz

Output Impedance

Test assembly	"Test Assembly for Output Impedance (VSWR)" (page 1.5).
Test method	<p>For the VSWR measurement of a source the effect of the level control must be taken into account. For this purpose, an auxiliary generator is used which transmits a wave with a slightly offset carrier frequency into the DUT. The difference frequency has to be within the control bandwidth of the level control. In the case of ideal source impedance, the wave from the auxiliary generator is not reflected by the DUT. In the case of not ideal DUT source impedance, the output wave of the DUT and the reflected wave of the auxiliary generator are superimposed on one another. A directional coupler couples a part of these outgoing superimposed waves to an analyzer. The frequency offset, results in a beat of the superimposed outgoing waves. The VSWR is the ratio between the maximum and minimum amplitude of the beat.</p>
Measurement	<ul style="list-style-type: none"> ➤ Settings on DUT: <ul style="list-style-type: none"> - Level: test level - Frequency: test frequency, unmodulated ➤ Settings on spectrum analyzer: <ul style="list-style-type: none"> - Test frequency, span 0 Hz, test level - Resolution and video bandwidth 10 kHz - Linear level scale - Sweep time 20 ms ➤ Settings on second signal generator: <ul style="list-style-type: none"> - set the frequency to the test frequency – 100 Hz, - set minimum level, unmodulated. ➤ Vary the reference level to bring the line displayed on the screen of the spectrum analyzer approximately into the middle of the screen. Measure the voltage of the signal V_{ref}. ➤ Unscrew the VSWR bridge from the DUT and let the test port open. Increase the level of the second signal generator until the voltage on the analyzer is $V_{ref} \pm 0.5 \%$. ➤ Screw the VSWR bridge onto the DUT again. ➤ Measure the maximum voltage V_{max} and minimum voltage V_{min} of the sinusoidal trace. Calculate the VSWR: $VSWR = V_{max}/V_{min}$
Recommended test frequencies and levels	<ul style="list-style-type: none"> ➤ Test frequencies: from 200 kHz every 50 MHz up to RF_{max}. ➤ Test levels: +2 dBm and +10 dBm.

Setting Time

Test assembly	Connect the spectrum analyzer (<i>Table 1-1</i> , item 19) to the RF connector of the DUT.
Test method	The spectrum analyzer is operated as a fast level meter in zero span. A controller transfers the start and the stop level via the IEC/IEEE bus. The analyzer is triggered by the positive edge on the EOI line of the IEC/IEEE bus. At switch over from start to stop level, the settling procedure is displayed on the screen of the analyzer.
Preparation of measurement	<ul style="list-style-type: none"> ➤ Synchronize the reference frequencies of the DUT and the analyzer. ➤ Make IEC/IEEE bus and RF connections. ➤ Connect spectrum analyzers trigger connector to EOI line (pin 5) of IEC/IEEE bus. ➤ Setting on DUT: <ul style="list-style-type: none"> - Frequency: test frequency unmodulated, - Level: start level ➤ Settings on spectrum analyzer: <ul style="list-style-type: none"> - REFERENCE LEVEL: target level + 3 dB - AMPLITUDE LOG RANGE 10 dB - RESOLUTION BANDWIDTH 200 kHz - VIDEO BANDWIDTH 2 MHz - SPAN 0 Hz - SWEEP TIME: 10 ms - TRIGGER EXTERN - External triggering by positive edge at 1.4 V.
Measurement	<ul style="list-style-type: none"> ➤ Send the stop level from the controller to the DUT. <ul style="list-style-type: none"> ⇒ The externally triggered analyzer displays the settling curve. The setting time is defined as the time from which on the level deviation from the final level is less than the specified deviation in the data sheet. ➤ Measure the following steps with ALC state AUTO, with ALC state OFF (Sample & Hold) and in List mode. ➤ Repeat the measurement with IQ-Modulation switched on: I/Q Settings menu: Source Analog Wideband I/Q Input State On supply 0.5 V DC to the I_{ext} Input Automatic Level Control menu State off ALC Off Mode Sample & Hold ➤ Repeat the measurement with ALC Off Mode Table ➤ Repeat the measurement with ALC State = on and in List-Mode

Recommended test frequencies and levels

Frequencies: 1 MHz, 30 MHz, 375 MHz, 1.1 GHz, 2.2 GHz, 3.2 GHz and 6 GHz

Start level	Stop level
-130 dBm	+18 dBm
-35 dBm	-5 dBm

Internal Modulation Generator

Frequency accuracy

The LF-Generator is integrated into an FPGA clocked with the same reference frequency as the synthesizer. Therefore, the LF frequency has the same accuracy as the RF and has not to be measured.

Distortions

Test equipment	Spectrum analyzer (Table 1-1 , item 19)
Test method	The fundamental and harmonics of the LF-generator are measured with the analyzer. The analyzer calculates the Total Harmonic Distortion with the 'Harmonic Distortion' function.
Test setup	<ul style="list-style-type: none"> ➤ Connect the spectrum analyzer to the LF socket of the DUT through a 150 Ω series resistor. This is necessary, because the LF output can only drive 200 Ω loads with very good harmonic distortion. If the instrument is equipped with a RFBOARD 1406.7207.xx switch the LF Gen output impedance to 600 Ω and omit the 150 Ω series resistor.
Measurement of frequency settings and distortion	<ul style="list-style-type: none"> ➤ Settings on DUT: LF Output menu: LF Gen Voltage 1 V LF Gen Frequency 1 kHz ➤ Settings of the spectrum analyzer: RF INPUT DC AMPT REF LEVEL 10 dBm FREQ CENTER = LF Gen Frequency MEAS ⇒ HARMONIC DISTOR RF ATTEN MANUAL increase by 10 dB ➤ Read the THD ➤ repeat the measurement at the recommended test frequencies by changing the DUT LF Gen Frequency and the analyzer center frequency.
Recommended test frequencies	100 Hz, 300 Hz, 1 kHz, 3 kHz, 10 kHz, 30 kHz, 100 kHz

Level Accuracy and Frequency response

Test equipment	AC voltmeter (<i>Table 1-1</i> , item 15)
Test method	The output level of the LF Generator is measured direct with an AC voltmeter.
Test setup	➤ Connect the AC voltmeter to the LF socket of the DUT.
Measurement of Level Accuracy	➤ Settings on DUT: LF Output menu: LF Gen Frequency 1 kHz set LF Output Voltage to recommended levels and measure the output level
Recommended test levels for Level Accuracy	3 mV, 10 mV, 30 mV, 100 mV, 300 mV, 1 V and 3 V
Measurement of Frequency response	➤ Settings on DUT: LF Output menu: LF Output Voltage 1 V set LF Gen Frequency to recommended test frequencies and measure the output level ⇒ Determine the highest and the lowest level V_{\max} and V_{\min} . The frequency response in dB is defined as: $D = 20 \cdot \log_{10}(V_{\max}) - 20 \cdot \log_{10}(V_{\min})$
Recommended test frequencies	10 Hz, 1 kHz, 10 kHz, 100 kHz and 1 MHz

Note: *The settling time is a pure computer time and needs therefore not to be measured.*

Amplitude Modulation

AM Setting Uncertainty

Test assembly	See section " Standard Test Assembly for Analog Modulations ", page 1.3 .
Measurement of accuracy versus modulation depth	<ul style="list-style-type: none"> ➤ Settings on DUT: <ul style="list-style-type: none"> RF On Frequency 150 MHz Level: 0 dBm Amplitude Modulation On <li style="padding-left: 20px;">AM Source Internal <li style="padding-left: 20px;">LF Gen Frequency 1 kHz ➤ Settings on analyzer: <ul style="list-style-type: none"> AMPTD ⇨ REF LEVEL test level + 6 dB , FREQ ⇨ CENTER 150 MHz FM DEMOD, <li style="padding-left: 20px;">FMDEMOD ON, <li style="padding-left: 20px;">RESULT DISPLAY ⇨ AM <li style="padding-left: 20px;">DEMOD BW 50 kHz <li style="padding-left: 20px;">RANGE ⇨ DEVIATION PER DIV 20 % <li style="padding-left: 20px;">MEAS TIME 100 ms ➤ set the AM Depth to the recommended modulation depths and read the modulation depth $\pm peak/2$ from the analyzer. ➤ set DUT to <ul style="list-style-type: none"> AM Source External, AM Ext Coupling AC, AM Depth 80%, LF Gen Output On, Connect LF output to MOD EXT input and read the modulation depth $\pm peak/2$ from the analyzer.
Recommended modulation depths	m = 5%, 10 %, 20 %, 40 %, 60 %, 80 %

<p>Measurement of accuracy versus RF</p>	<ul style="list-style-type: none"> ➤ Settings on DUT: RF On Frequency recommended test frequencies Level: 0 dBm Amplitude Modulation On AM Source Internal LF Gen Frequency 1 kHz AM Depth 80 % ➤ Settings on analyzer: AMPTD ⇨ REF LEVEL 6 dBm , FREQ ⇨ CENTER same as DUT FM DEMOD, FMDEMOD ON, RESULT DISPLAY ⇨ AM DEMOD BW 50 kHz RANGE ⇨ DEVIATION PER DIV 20 % MEAS TIME 100 ms ➤ measure the modulation depth for all recommended test frequencies
<p>Recommended test frequencies</p>	<ul style="list-style-type: none"> ➤ 100 kHz; 23.4375 MHz; 23.438 MHz; 374.9 MHz; 375 MHz; 529.9 MHz; 530 MHz; 1449.9 MHz; 1450 MHz; 2120.9 MHz; 2121 MHz; 2999.9 MHz; 3000 MHz; 3999.9 MHz; 4 GHz; 6 GHz

AM Distortion

Test assembly	See section " Standard Test Assembly for Analog Modulations ", page 1.3.
Measurement	<ul style="list-style-type: none"> ➤ Settings on DUT: RF On Level 0 dBm Amplitude Modulation menu: LF Gen Frequency 1 kHz Source Internal AM depth 30%. ➤ Settings on R&S FSQ: AMPTD / REF LEVEL 6 dBm, FREQ / CENTER test frequency FM DEMOD, FMDEMOD ON, RESULT DISPLAY ⇒ AM RESULT DISPLAY ⇒ AF SPECTRUM DEMOD BW > 7* f_{mod}, RANGE ⇒ DEVIATION PER DIV 20 % MEAS TIME 0.16 s ➤ Measure the THD for all recommended test frequencies. To convert the displayed THD value in dB to percent calculate: $THD_{pct} = 100 * 10^{(THD_{dB}/20)}$. ➤ Repeat the measurement with AM depth set to 80 %.
Recommended test frequencies	<ul style="list-style-type: none"> ➤ 100 kHz, 23.4375 MHz; 23.438 MHz, 374.9 MHz; 375 MHz; 529.9 MHz; 530 MHz; 1449.9 MHz; 1450 MHz; 2120.9 MHz; 2121 MHz; 2999.9 MHz; 3000 MHz; 3999.9 MHz; 4 GHz; 6 GHz

AM Frequency Response

Test assembly	See section " Standard Test Assembly for Analog Modulations ", page 1.3.												
Measurement	<ul style="list-style-type: none"> ➤ Settings on DUT: RF On Level 0 dBm Amplitude Modulation menu: Source External External Coupling DC AM depth 60%. ➤ Settings on R&S FSQ: AMPTD / REF LEVEL 6 dBm, FREQ / CENTER test frequency FM DEMOD, FMDEMOD ON, RESULT DISPLAY ⇒ AM RESULT DISPLAY ⇒ AF SPECTRUM DEMOD BW 200 kHz, RANGE ⇒ DEVIATION PER DIV 20 % MEAS TIME ≥ 16/fmod s ➤ Vary the carrier frequency from 1 MHz to RF_{max}. Recommended test frequencies 1 MHz, 46.87 MHz, 186.9 MHz, 1.1 GHz, 2.2GHz, 3.2 GHz, 6 GHz . ➤ Settings on the signal generator: - LF Output ON - LFGen Voltage 1 V (V_{peak}). ➤ Set the generator frequency to the frequencies given below and measure the modulation depth in RMS. <table border="1" data-bbox="616 1195 1342 1278" style="width: 100%; border-collapse: collapse; text-align: center;"> <tr> <td style="padding: 2px;">Gen. frequency</td> <td style="padding: 2px;">10 Hz</td> <td style="padding: 2px;">100 Hz</td> <td style="padding: 2px;">1 kHz</td> <td style="padding: 2px;">10 kHz</td> <td style="padding: 2px;">50 kHz</td> </tr> <tr> <td style="padding: 2px;">MEAS TIME</td> <td style="padding: 2px;">1.6 s</td> <td style="padding: 2px;">0.2 s</td> <td style="padding: 2px;">0.2 s</td> <td style="padding: 2px;">0.2 s</td> <td style="padding: 2px;">0.2 s</td> </tr> </table> <p style="margin-left: 20px;">⇒ The modulation frequency response in dB is the difference between the greatest and the smallest modulation depth m_{max} and m_{min}:</p> $m_{\text{max-min}} = 20 * \log_{10}(m_{\text{max}}) - 20 * \log_{10}(m_{\text{min}})$	Gen. frequency	10 Hz	100 Hz	1 kHz	10 kHz	50 kHz	MEAS TIME	1.6 s	0.2 s	0.2 s	0.2 s	0.2 s
Gen. frequency	10 Hz	100 Hz	1 kHz	10 kHz	50 kHz								
MEAS TIME	1.6 s	0.2 s	0.2 s	0.2 s	0.2 s								
	<ul style="list-style-type: none"> ➤ Repeat the measurement at RF = 1 GHz with the setting Amplitude Modulation ⇒ External Coupling AC ➤ Repeat the measurement at RF = 1 GHz with the internal modulation generator with the setting Amplitude Modulation ⇒ Source Internal. 												

Synchronous PhiM with AM

<p>Test assembly</p>	<p>See section "Standard Test Assembly for Analog Modulations", page 1.3.</p>
<p>➤ Measurement</p>	<ul style="list-style-type: none"> ➤ Settings on DUT: <ul style="list-style-type: none"> RF On Level PEP = P_{max}0 dBm Amplitude Modulation menu: <ul style="list-style-type: none"> LF Gen Frequency 1 kHz Source Internal AM depth 30%. ➤ Settings on spectrum analyzer <ul style="list-style-type: none"> AMPTD / REF LEVEL 3 dBm , FM DEMOD <ul style="list-style-type: none"> DEMOD BW 12.5 kHz MEAS TIME 100 ms RESULT DISPLAY ⇨ PM ➤ Recommended test frequencies. 23.4375 MHz, 46.87 MHz, 186.9 MHz, 1.1 GHz, 2.2GHz, 3.2 GHz, 4 GHz, 5 GHz, 6 GHz ➤ Measure the resulting phase modulation with peak detection ($\pm peak/2$-value).

Frequency Modulation

Test Methods

Test assembly	See section " Standard Test Assembly for Analog Modulations ", page 1.3.
Test Method "FFT Demodulation (Option R&S FS-K7)"	<p>The FM deviation and distortion are determined by digital signal processing in the spectrum analyzer.</p> <ul style="list-style-type: none"> ➤ Settings on R&S FSQ: <ul style="list-style-type: none"> AMPTD / REF LEVEL test level, FREQ / CENTER test frequency FMDEMOMOD, FMDEMOMOD ON, RESULT DISPLAY / FM resp. PM DEMOMOD BW > 2 * (deviation + fmod) for FM, DEMOMOD BW > 2 * fmod * (1 + deviation) for PM, RANGE / DEVIATION PER DIV 0.5 * deviation MEAS TIME 3/fmod for distortion (up to 3rd harmonic) <ul style="list-style-type: none"> RESULT DISPLAY / FM resp. PM / AF SPECTRUM DEMOMOD BW > 2 * (deviation + 3.5 * fmod) for FM, DEMOMOD BW > 7 * fmod * (1 + deviation) for PM, MEAS TIME 16/fmod

FM Setting Uncertainty

Test Method	➤ FFT Demodulation (see chapter " Test ")
Measurement	<ul style="list-style-type: none"> ➤ Settings on DUT: <ul style="list-style-type: none"> RF On Level 0 dBm: Frequency Modulation menu: State on FM Source Internal FM Mode Normal
Recommended settings	<ul style="list-style-type: none"> ➤ Recommended test frequencies: 10 MHz, 1000 MHz with LFGen Freq = 1 kHz, FM Deviation = 100 kHz ➤ Repeat measurement at 1000 MHz with changing settings to <ul style="list-style-type: none"> FM Source External FM Ext Coupling AC feed in a 1 kHz, 1Vp external modulation signal at the MOD EXT connector

FM Distortion

Test Method	FFT Demodulation (see chapter " Test ")
Measurement	<ul style="list-style-type: none"> ➤ Settings on DUT: RF On Level 0 dBm: Frequency Modulation menu: State on FM Source Internal FM Mode Normal LFGGen Frequency 2 kHz. ➤ Settings on R&S FSQ: DEMOD BW 5 * FM deviation, RANGE / DEVIATION PER DIV 250 kHz, RESULT DISPLAY / FM, AF SPECTRUM, SWEEP / MEAS TIME 50 ms, FREQ / AF STOP 50 kHz. ➤ Read the THD from the display. To convert to percent calculate $THD_{pct} = 100 * 10^{(THD_{dB}/20)}$.
Recommended settings	<ul style="list-style-type: none"> ➤ CF sweep Recommended test frequencies with FM deviation 250 kHz: 10 MHz, with FM deviation 500 kHz: 375.1 MHz, 500 MHz, 625 MHz, 750 MHz, with FM deviation 1 MHz: 1100 MHz, with FM deviation 2 MHz: 2200 MHz, with FM deviation 4 MHz: 3200 MHz, 6 GHz ➤ Repeat measurement with changing settings to FM Mode Low Noise FM deviation 500 kHz for test frequencies: 375.1 MHz, 750 MHz ➤ Repeat measurement with changing settings to FM Mode High Deviation FM deviation 500 kHz for test frequencies: 375.1 MHz, 750 MHz

FM Frequency Response

Test Method	FFT Demodulation (see chapter " Test ")
Measurement	<ul style="list-style-type: none">➤ Settings on DUT: RF On Level 0 dBm Frequency Modulation menu: FM Source External FM Ext Coupling DC FM Mode Normal FM deviation: 100 kHz ➤ Setting on the signal generator: The internal LF generator of the signal generator delivers the modulation signal to the external modulation input of the DUT. The level of the modulation signal is controlled by use of an AC voltmeter (Item 15 of Table 1-1).<ul style="list-style-type: none">- LFGGen Voltage 1 V peak- State ON ➤ Settings on R&S FSQ: FFT Demodulation ➤ Vary the signal generator frequency and measure the modulation deviation. ⇨ The modulation frequency response is the factor between the greatest and the smallest modulation deviation.

<p>Recommended settings</p>	<ul style="list-style-type: none"> ➤ LF in logarithmic steps, 3 steps per decade (1, 2, 5) from 10 Hz to 500 kHz ➤ Perform the measurement for test frequency 23 MHz. ➤ Repeat the measurement with changing the settings to FM Ext Coupling AC for test frequency 23 MHz. ➤ Repeat the measurement with changing the settings to FM Ext Coupling AC FM deviation: 1 MHz for test frequencies: 375.1 MHz, 500 MHz, 625 MHz, 750 MHz. LF sweep from 1 kHz to 500 kHz ➤ Repeat the measurement with changing the settings to FM Ext Coupling AC FM Mode Low Noise FM deviation 500 kHz at test frequency 500 MHz. LF sweep from 1 kHz to 100 kHz ➤ Repeat the measurement with changing the settings to FM Ext Coupling AC FM Mode High Deviation FM deviation 2 MHz at test frequency 500 MHz. LF sweep from 1 kHz to 100 kHz ➤ Repeat the measurement with changing the settings to FM Source Internal FM Mode Normal FM deviation 1 MHz at test frequency 500 MHz. LF sweep from 1 kHz to 500 kHz
-----------------------------	---

Synchronous AM with FM

Test assembly	See section " Standard Test Assembly for Analog Modulations ", page 1.3.
Measurement	<ul style="list-style-type: none"> ➤ Settings on DUT: <ul style="list-style-type: none"> RF On Level 0 dBm Frequency Modulation menu: <ul style="list-style-type: none"> State on FM Source Internal FM Mode Normal FM deviation 40 kHz LFGen Frequency 1 kHz. ➤ Settings on spectrum analyzer <ul style="list-style-type: none"> AMPTD / REF LEVEL 6 dBm FREQ / CENTER test frequency FMDEMOD, FMDEMOD ON, RESULT DISPLAY / AM / AF Spectrum AF Start = 0 Hz AF Stop = 5 kHz RES BW = 30 Hz DEMOD BW = 100 kHz IF BW MANUAL 10 MHz, RANGE / REFERENCE VALUE 0.2 % MEAS TIME 3 ms ➤ Read the AM depth at 1 kHz modulation frequency from the demodulated AF spectrum.
Recommended settings	<ul style="list-style-type: none"> ➤ CF sweep Recommended test frequencies: 23.4 MHz, 375 MHz, 500 MHz, 750 MHz, 1100 MHz, 2200 MHz, 3200 MHz, 6 GHz

Carrier Frequency Offset with FM

Test assembly	See section " Standard Test Assembly for Analog Modulations ", page 1.3.
Measurement	<ul style="list-style-type: none"> ➤ Settings on DUT: <ul style="list-style-type: none"> RF On Level 0 dBm Frequency 1 GHz Frequency Modulation menu: <ul style="list-style-type: none"> State on FM Source Internal FM Mode Normal FM deviation 1 MHz LFGGen Frequency 10 kHz. ➤ Settings on spectrum analyzer <ul style="list-style-type: none"> AMPT / REF LEVEL 0 dBm FREQ / CENTER 1 GHz SPAN 10 kHz MKR / SIGNAL COUNT / NEXT / CNT RESOL 10 Hz ➤ Terminate the DUT External Modulation input with 50 Ω and execute the internal FM offset adjustment. <ul style="list-style-type: none"> ➤ Execute a single sweep. Using MKR→ / PEAK, read counted marker frequency. ⇒ The offset is the difference between marker frequency and set carrier frequency. ➤ Repeat measurement with FM source external, coupling ac and dc (2 measurements).

Phase Modulation

PhiM Setting Uncertainty

Test Method	FFT Demodulation (see chapter " Test ").
Measurement	<ul style="list-style-type: none"> ➤ Settings on DUT: RF On Level 0 dBm Phase Modulation menu: State on PhiM Source Internal PhiM Mode Normal PhiM Deviation 1 rad LFGGen Freq = 1 kHz ➤ Settings on spectrum analyzer: see chapter "Test"
Recommended settings	<ul style="list-style-type: none"> ➤ Recommended test frequencies: 10 MHz and 500 MHz ➤ Repeat measurement at 500 MHz with changing settings to PhiM Source External PhiM Ext Coupling AC feed in a 1 kHz external modulation signal at MOD EXT connector

PhiM Distortion

Test Method	FFT Demodulation (see chapter " Test ")
Measurement	<ul style="list-style-type: none"> ➤ Settings on DUT: RF On Level 0 dBm Phase Modulation menu: State on PhiM Source Internal PhiM Mode Normal LFGGen Frequency 10 kHz ➤ Settings on R&S FSQ: see chapter "Test " SWEEP / MEAS TIME 50 ms, FREQ / AF STOP 50 kHz, AMPTD / REF LEVEL 0 dBm, FREQ / CENTER test frequency. ➤ Read THD from the Display. To convert to percent calculate $THD_{pct} = 100 * 10^{(THD_{dB}/20)}$.
Recommended settings	<ul style="list-style-type: none"> ➤ CF sweep Recommended test frequencies with PhiM deviation 1 rad: 10 MHz, 375.1 MHz, 500 MHz, 625 MHz, 750 MHz, with PhiM deviation 2 rad: 1100 MHz, with PhiM deviation 4 rad: 2200 MHz, with PhiM deviation 8 rad: 3200 MHz, 6 GHz ➤ Repeat measurement with changing settings to PhiM Mode Low Noise PhiM deviation 2.5 rad for test frequencies: 375.1 MHz, 750 MHz ➤ Repeat measurement with changing settings to PhiM Mode High Deviation PhiM deviation 10 rad for test frequencies: 375.1 MHz, 750 MHz

PhiM Frequency Response

Test method	FFT Demodulation (see chapter " Test ").
Measurement	<ul style="list-style-type: none"> ➤ Settings on DUT: RF On Level 0 dBm Phase Modulation menu: PhiM Source External PhiM Ext Coupling DC PhiM Mode Normal PhiM deviation: 2 rad ➤ Setting on the signal generator: The internal LF generator of the signal generator delivers the modulation signal to the external modulation input of the DUT. The level of the modulation signal is controlled by use of an AC voltmeter (Item 15 of Table 1-1). - LFGGen Voltage 1 V peak - State ON ➤ Settings on R&S FSQ: FFT Demodulation ➤ Vary the signal generator frequency and measure the modulation deviation. ⇒ The modulation frequency response is the factor between the greatest and the smallest modulation deviation.
Recommended settings	<ul style="list-style-type: none"> ➤ LF in logarithmic steps, 3 steps per decade (1, 2, 5) from 10 Hz to 500 kHz ➤ Perform the measurement for test frequency 23 MHz ➤ Repeat the measurement with changing the settings to PhiM Ext Coupling AC for test frequency 23 MHz. ➤ Repeat the measurement with changing the settings to PhiM Ext Coupling AC for test frequencies: 375.1 MHz, 500 MHz, 625 MHz, 750 MHz. LF sweep from 1 kHz to 500 kHz ➤ Repeat the measurement with changing the settings to PhiM Ext Coupling AC PhiM Mode Low Noise PhiM deviation 5 rad at test frequency 500 MHz. LF sweep from 1 kHz to 100 kHz ➤ Repeat the measurement with changing the settings to PhiM Ext Coupling AC PhiM Mode High Deviation PhiM deviation 20 rad at test frequency 500 MHz. LF sweep from 1 kHz to 100 kHz ➤ Repeat the measurement with changing the settings to PhiM Source Internal PhiM Mode Normal PhiM deviation 2 rad at test frequency 500 MHz. LF sweep from 1 kHz to 500 kHz

Pulse Modulation

ON/OFF Ratio

Test equipment	<ul style="list-style-type: none"> - Spectrum analyzer (Table 1-1, item 19) - Pulse generator (Table 1-1, item 13)
Test setup	<ul style="list-style-type: none"> ➤ To determine the ON/OFF ratio, connect the spectrum analyzer to the RF output socket of the DUT and let the PULSE EXT input open.
Measurement	<ul style="list-style-type: none"> ➤ Setting on DUT: <ul style="list-style-type: none"> RF On Level 0 dBm Frequency recommended test frequencies Pulse Modulation menu: <ul style="list-style-type: none"> Source External State On Polarity Inverse ➤ Setting on Analyzer <ul style="list-style-type: none"> FREQ/CENTER test frequency SPAN 0 Hz AMPT/REF LEVEL 0 dBm BW ⇒ RES BW MANUAL 3 kHz SWEEP ⇒ SWEEP TIME MANUAL 100 ms MEAS ⇒ TIME DOM POWER on ➤ Determine the output level of the DUT at the recommended test frequencies with <ul style="list-style-type: none"> Pulse Modulation ⇒ Polarity Inverse and Pulse Modulation ⇒ Polarity Normal. <ul style="list-style-type: none"> ⇒ The level difference between the output level with Polarity Inverse and Polarity Normal is the ON/OFF ratio.
Recommended test frequencies	5 MHz, 150 MHz, 400 MHz, 1.1 GHz, 2.2 GHz, 3.2 GHz, 4 GHz, 5 GHz, 6 GHz

Rise/ Fall Time

Test assembly	Test Assembly for Pulse Modulation (see page 1.3)
Test method	The RF signal is down converted to 0 Hz in phase. Thus, the IF output reproduces the RF amplitude vs. time.
Measurement	<ul style="list-style-type: none"> ➤ Setting on pulse generator: For adjustment statically high level, for measurement square wave pulse sequence with a frequency of 1 MHz, TTL level ➤ Setting on DUT: RF On Level 0 dBm Frequency recommended test frequencies Pulse Modulation menu: State On ➤ Setting on Signal Generator: RF On Level Recommended Lo-Level of Mixer Frequency same as DUT ➤ Setting on oscilloscope: Adjust V/div according to the mixer in use Time base 20 ns/div Trigger: - for adjustment free running, - for measurement 50 % of signal amplitude, rising and falling edge. ➤ Adjustment: At each test frequency adjust phase using menu RF Mod / Frequency/Phase / Phase Settings. Vary the Delta Phase to obtain maximal signal output at the mixers IF port. The voltage at maximum corresponds to 100 % of RF amplitude. ➤ Measurement: Evaluate the down converted pulse-modulated signal on the oscilloscope. <p style="margin-left: 40px;">⇨ Rise time = time between 10% and 90% of signal amplitude Fall time = time between 90% and 10% of signal amplitude</p>
Recommended test frequencies	400 MHz, 1.1 GHz, 2.2 GHz, 3.2 GHz, 4 GHz, 5 GHz, 6 GHz

Video Crosstalk

Test assembly	As above for ON/OFF Ratio
Measurement	<ul style="list-style-type: none"> ➤ Setting on pulse generator: Square wave pulse sequence with a frequency of 100 kHz, TTL level ➤ Setting on DUT: RF On Frequency 1 GHz, 6 GHz Level 0 dBm Pulse Modulation State On ➤ Settings on the Analyzer REF LEVEL 0 dBm FREQ CENTER 100 kHz SPAN 10 kHz ➤ Measure the signal level at 100 kHz with the analyzer. <ul style="list-style-type: none"> ⇒ The Video Crosstalk is the amplitude of the spectral line found at 100 kHz related to the RF carrier level

Pulse Generator

PULSE VIDEO

Test equipment	- Storage oscilloscope (Table 1-1 , item 7) with 50Ω Feed-through termination on input.
Test setup	➤ Connect the PULSE VIDEO socket on the rear of the DUT to the storage oscilloscope.
Measurement	<p>Setting on DUT:</p> <p>Pulse Modulation menu: State On Source: Pulse Generator</p> <p>Pulse Generator menu: State On Pulse Period 10 μs Pulse Width 5 μs</p> <ul style="list-style-type: none"> ➤ Setting on oscilloscope: 1 V/div Time base 2.5 μs/div Trigger: 50 % of amplitude, rising edge. ➤ Check the signal for a symmetric square wave with 10 μs pulse period and 3 V amplitude. Rise and fall time < 10 ns

I/Q modulation

Input Impedance (VSWR)

Test equipment	" Test Assembly for Output Impedance (VSWR) " (page 1.5)
Test method	➤ Same as for the output impedance of the DUT.
Test setup	➤ Connect the test port of the VSWR bridge to the I or Q input instead of the RF output.
Measurement	<p>➤ Settings on DUT: Frequency 900 MHz Level 0 dBm I/Q Settings menu: Source Analog Wideband I/Q Input State On</p> <p>➤ Settings on signal generator: - Level: 10 dBm - Frequency: test frequencies</p> <p>➤ Let the measuring port of the VSWR bridge unconnected and measure the level P_{ref} as reference level.</p> <p>➤ Connect the VSWR bridge to the I input and measure the level P_I.</p> <p>➤ Calculate the VSWR:</p> $VSWR = \frac{1 + \sqrt{P_I / P_{ref}}}{1 - \sqrt{P_I / P_{ref}}}$ <p>➤ Repeat the measurement for the Q input.</p>
Recommended test frequencies	➤ 1 MHz, 10 MHz, 20 MHz, 30 MHz, 40 MHz, 50 MHz, 60 MHz

RF Frequency Response due to Modulation

Test equipment	<ul style="list-style-type: none"> - Spectrum analyzer (Table 1-1, item 19) - Signal generator (Table 1-1, item 5)
Test setup	<ul style="list-style-type: none"> ➤ Connect the RF output of the DUT to the spectrum analyzer, and connect the signal generator to the I input of the DUT.
Test method	<p>By applying a sinewave AC voltage to the I (or Q) input, an amplitude modulation with a suppressed carrier is generated. The modulation frequency response is determined by measuring the sideband power as a function of the frequency of the applied AC voltage. The difference between the highest and the lowest sideband level, found by varying the modulation frequency is the frequency response to be measured.</p>
Measurement	<ul style="list-style-type: none"> ➤ Settings on DUT: <ul style="list-style-type: none"> RF On Frequency Test frequency Level 0 dBm ALC S&H I/Q Settings menu: <ul style="list-style-type: none"> Source Analog Wideband I/Q Input Crest Factor 3 dB State On ➤ Setting on signal generator: <ul style="list-style-type: none"> Level 4 dBm corresponding to 0.5 V (Vpeak) ➤ Settings on spectrum analyzer <ul style="list-style-type: none"> AMPT/REF LEVEL 5 dBm, SPAN 160 MHz Center test frequency ➤ Measure the sideband levels these for modulation frequencies: 1 MHz, 5 MHz and from 10 MHz to 60 MHz in 10 MHz steps. <p>⇒ The modulation frequency response is the difference between the highest and the lowest measured sideband level.</p>
Recommended test frequencies	<ul style="list-style-type: none"> ➤ 117 MHz, 255 MHz, 360 MHz, 470 MHz, 690 MHz, 1000 MHz, 1400 MHz, 2000 MHz, 2850 MHz, 3900 MHz, 5000 MHz, 5940 MHz ➤ repeat measurement at 3432 MHz, 3960 MHz and 4488 MHz with modulation frequencies from 14 MHz up to 264 MHz in 25 MHz steps with 10 dB reduced Baseband-level

Error Vector

Test assembly	See section " Test Assembly for I/Q Modulation ", page 1.6.
Measurement	<p>Instead of a static measurement, an equivalent dynamic measurement with a low symbol rate is carried out.</p> <ul style="list-style-type: none"> ➤ Settings on DUT: <ul style="list-style-type: none"> RF On Level 0 dBm I/Q Settings menu: <ul style="list-style-type: none"> Source Analog Wideband I/Q Input State On ➤ Generate a modulation signal on the ARB generator using the controller and the simulation program: <ul style="list-style-type: none"> - Modulation 16QAM - No coding - SQR COS filter with $\alpha = 0.5$ - PRBS-9 data sequence - Pulse width and over sampling 32 - Length 100 symbols - Symbol clock 10 kHz ➤ Check if the channels on the ARB generator are equal and adjust if necessary. ➤ Make the corresponding settings on the demodulator. Result length 80 symbols. ➤ Measure the error vector magnitude (peak and rms) at the recommended test frequencies. ➤ If an internal baseband is installed generate the modulation signal internally and repeat the measurement at 200.1 MHz
Recommended test frequencies	20 MHz, 200MHz, 200.1 MHz, 500 MHz, 1 GHz, 1.5 GHz, 2 GHz, 3.5 GHz, 3.2 GHz, 3.5 GHz, 4 GHz, 4.5 GHz, 5 GHz, 5.5 GHz, 6 GHz

Residual Carrier and Leakage

Test equipment	Spectrum analyzer (Table 1-1 , item 19)
Test setup	➤ Connect the spectrum analyzer to the RF output of the DUT.
Measurement	<ul style="list-style-type: none"> ➤ Settings on DUT: <ul style="list-style-type: none"> RF On Frequency test frequency Level 0 dBm I/Q Settings menu: Source Analog Wideband I/Q Input State Off ➤ Settings on analyzer: <ul style="list-style-type: none"> FREQ/CENTER = test frequency, SPAN 1 MHz, AMPT/REF LEVEL = test level ➤ First measure the unmodulated level P_{ref} as a reference. ➤ Then switch on I/Q modulation with open I- and Q-inputs (I/Q Settings menu: State On) and measure the residual carrier level $P_{carrier}$. <ul style="list-style-type: none"> ⇒ The carrier suppression in dBc is: <ul style="list-style-type: none"> $D_{carrier} = P_{ref} - P_{carrier}$ in dBc = referred to the carrier. ➤ Starting from 100 MHz and then every 100 MHz set Impairments State to On and Leakage to 10% on the DUT. <ul style="list-style-type: none"> ⇒ The residual carrier should increase to 10% (-20 dBc).
Recommended test frequencies	➤ 12.5 MHz to 5987.5 MHz in 25 MHz steps

I/Q Imbalance

Measurement of imbalance	
Test equipment	<ul style="list-style-type: none"> - Spectrum analyzer (<i>Table 1-1</i>, item 19) - Adjustable DC voltage source (<i>Table 1-1</i>, item 5)
Test setup	<ul style="list-style-type: none"> ➤ Connect the spectrum analyzer to the RF output of the DUT. ➤ Connect the DC voltage source to the I or the Q input.
Measurement	<ul style="list-style-type: none"> ➤ Settings on DUT: <ul style="list-style-type: none"> RF On Frequency 900 MHz Level 0 dBm ALC State OFF, S&H I/Q Settings menu: <ul style="list-style-type: none"> Source Analog Wideband I/Q Input State On Impairments State on Imbalance 1.0 dB ➤ Settings on analyzer: <ul style="list-style-type: none"> - Center frequency = test frequency, span 1 MHz - Reference level = test level +3 dB - Scale 1 dB/div ➤ Apply a DC voltage of 0.5 V to the I-input and let the Q-input open. Measure the output level P_I. Then connect the DC voltage to the Q-input and let the I-input open. Measure the level P_Q. The Imbalance is: Imbalance = $P_I - P_Q$

Image Rejection

Test equipment	Spectrum analyzer (<i>Table 1-1</i> , item 24) Baseband Signal generator
Test setup	<ul style="list-style-type: none"> ➤ Connect I/Q-Signals from the Baseband Signal Generator to the I/Q Modulation Inputs of the DUT. ➤ Connect the spectrum analyzer to the RF output of the DUT.
Test method	A single sideband signal is generated using a DC Test-Waveform. The offset is set with the Frequency Offset function in the Baseband menu. The image rejection is the difference between the shifted signal and its mirror on the opposite side of the center frequency.
Measurement	<ul style="list-style-type: none"> ➤ Settings on Baseband Signal Generator <ul style="list-style-type: none"> ARB: Load Waveform /var/smbv/Lists/PerfTest/Test_DC.wv (included in SMBV100A firmware) State On Frequency Offset: 10 kHz, 10 MHz to 40 MHz in 10 MHz steps, -10 kHz, -10 MHz to -40 MHz in -10 MHz steps ➤ Settings on DUT <ul style="list-style-type: none"> RF On Frequency: 1 GHz Level: 0 dBm ➤ Settings on analyzer <ul style="list-style-type: none"> FREQ CENTER 1 GHz SPAN = 3 x offset frequency BW COUPLING RATIO SPAN / RBW MANUAL 300 AMPT/REF LEVEL 5 dBm MKR /MARKER 1 set to peak ➤ In the displayed spectrum, use MARKER DELTA to measure the suppression of the unwanted signal image (i.e. for a carrier at 990 MHz = 1 GHz – 10 MHz the unwanted image is located at 1 GHz + 10 MHz = 1010 MHz)

Adjacent Channel Power for 3GPP FDD

If the DUT includes the options R&S SMBV-B10 (Baseband Generator) and R&S SMBV-K42 (Digital Standard 3GPP FDD) or options R&S SMBV-B50/B51 (ARB Generator) with R&S WinIQSIM2™ including R&S SMBV-K242 (Digital Standard 3GPP FDD) the modulation signal can be generated internally in the DUT. If none of these options are included in the DUT an I/Q-modulation source generating a 3GPP Test Model 1-64 is needed as signal source.

Test equipment	Signal analyzer R&S FSQ including option R&S FSQ-K70 (Vector Signal Analysis) (Table 1-1 , item 19) Signal generator (Table 1-1 , item 5)
Test setup	<ul style="list-style-type: none"> ➤ Connect I/Q-outputs of the DUT to its I/Q-inputs if the modulation signal is generated internally. If not connect the IQ-modulation source to the I/Q-inputs of the DUT. ➤ Connect signal analyzer to RF output of DUT.
Test method	Set standard 3GPP FDD Test Model 1-64 in the baseband and feed the I/Q signal into the DUT I/Q-inputs. Perform the measurements with the 3GPP measurement setting of the R&S FSQ.
Measurement	<p>Settings on DUT Level: 13 dBm Frequencies: 2160 MHz I/Q Settings menu: Source Analog Wideband IQ in State On Crest Factor 10.7 dB</p> <ul style="list-style-type: none"> ➤ Settings on DUT or signal generator 3GPP FDD: Test Setups Test_Model_1_64channels State ON ➤ Settings on analyzer FREQ CENTER: 2160 MHz MEAS → CHAN PWR ACP → CP /ACP STANDARD WCDMA 3GPP FWD → SWEEP TIME 1 sec → NOISE CORR ON → ADJUST REF LVL ➤ Measure ACP: Read out Adjacent Channel and Alternate Channel (take the larger of the two measurement values UPPER/LOWER) ➤ If internal Baseband generation option R&S SMBV-K42 (Digital Standard 3GPP FDD) is included set I/Q-Settings Internal Baseband Repeat the Measurement at 2160 MHz

Internal Baseband Generator

Modulated RF Frequency Response over the Complete Unit

The equipment layout for generating single sideband signals includes the options R&S SMBV-B10, R&S SMBV-B50 or R&S SMBV-B51 (baseband generator).

Test equipment	Signal analyzer R&S FSQ (Table 1-1 , item 19)
Test setup	<ul style="list-style-type: none"> ➤ Connect the RF output of the DUT to the signal analyzer.
Test method	<p>A single sideband signal is generated using a DC Test-Waveform. The test frequency is set with the Frequency Offset function in the Baseband menu. Test frequencies are set one after the other, 0 Hz is the reference. The modulation frequency response is determined by measuring the sideband power as a function of the frequency of the applied AC voltage. The difference between the highest and lowest sideband level, found by varying the modulation frequency, is the frequency response to be measured.</p>
Measurement	<ul style="list-style-type: none"> ➤ Settings on DUT <ul style="list-style-type: none"> RF On Frequency: measurement frequencies Level: 0 dBm Level: 0 dBm ARB: <ul style="list-style-type: none"> Load Waveform /var/smbv/Lists/PerfTest/Test_DC.wv State On I/Q Mod: Wideband I/Q On ➤ Settings on analyzer <ul style="list-style-type: none"> FREQ CENTER measurement frequency + test frequency AMPT/REF LEVEL 5 dBm, SPAN 5 MHz ➤ For all measurement frequencies with the specified frequency offset measure the sideband level. <p>The modulation frequency response is the difference from the highest to the lowest sideband.</p> <p>Test frequencies: 0 Hz (reference), ± 1 MHz, ± 3 MHz, ± 10 MHz, ± 25 MHz, ± 30 MHz, ± 35 MHz, ± 45 MHz, ± 55 MHz, ± 60 MHz for BBGEN Board Revision ≥ 05.00: additional ±70MHz, ±80MHz (up to the maximum modulation bandwidth of the baseband generator)</p> <p>Measurement frequencies: 850 MHz, 1750 MHz, 2200 MHz, 5000 MHz</p>

Image Rejection over the Complete Unit

The equipment layout for generating single sideband signals includes the options R&S SMBV-B10, R&S SMBV-B50 or R&S SMBV-B51 (baseband generator).

Test equipment	Signal analyzer R&S FSQ (Table 1-1 , item 19).
Test setup	➤ Connect the signal analyzer to the RF output of the DUT.
Test method	A single sideband signal is generated using a DC Test-Waveform. The offset is set with the Frequency Offset function in the Baseband menu. The image rejection is the difference between the shifted signal and its mirror on the opposite side of the center frequency.
Measurement	<p>Settings on DUT</p> <p>RF On</p> <p>Frequency: 1 GHz</p> <p>Level: 0 dBm</p> <p>ARB:</p> <p style="padding-left: 20px;">Load Waveform /var/smbv/Lists/PerfTest/Test_DC.wv</p> <p>State On</p> <p>Frequency Offset:</p> <p style="padding-left: 20px;">10 kHz, 10 MHz to 60 MHz in 10 MHz steps, -10 kHz, -10 MHz to -60 MHz in -10 MHz steps</p> <p style="padding-left: 20px;">for BBGEN Board Revision ≥ 05.00: additional ±70MHz, ±80MHz (up to the maximum modulation bandwidth of the baseband generator)</p> <p>➤ Settings on analyzer</p> <p style="padding-left: 20px;">FREQ CENTER 1 GHz</p> <p style="padding-left: 20px;">SPAN = 3 x offset frequency</p> <p style="padding-left: 20px;">BW COUPLING RATIO SPAN / RBW MANUAL 300</p> <p style="padding-left: 20px;">AMPT/REF LEVEL 5 dBm</p> <p style="padding-left: 20px;">MKR /MARKER 1 set to peak</p> <p>➤ In the displayed spectrum, use MARKER DELTA to measure the image rejection.</p>

IQ Output

IQ Output, Frequency Response and Imbalance

Important:

Before the measurement, Signal Analyzer R&S FSQ must be calibrated as follows by means of a reference measurement at the measurement frequency in question:

1. Connect the RF output of the DUT to the power meter and measure the output level.
2. Include the measured level as a reference value/calibration value in the R&S FSQ.

Test equipment	Signal analyzer R&S FSQ (Table 1-1 , item 19).
Test setup	Connect the signal analyzer to the I, IN, Q, QN-output of the DUT.
Test method	<p>A single sideband signal is generated using a DC Test-Waveform. The test frequency is set with the Frequency Offset function in the Baseband menu. The test frequencies are set one after the other. 1 MHz is the reference. The level of the reference must be checked (3,979 dBm ± 0,1 dBm).</p> <p>The imbalance is obtained from the level differences between I and Q at a particular frequency.</p>
Measurement	<ul style="list-style-type: none"> ➤ Settings on DUT <ul style="list-style-type: none"> Frequency: 100 MHz Level: 0 dBm ARB: <ul style="list-style-type: none"> Load Waveform /var/smbv/Lists/PerfTest/Test_DC.wv State On Frequency Offset: measurement frequency Optimize internal I/Q Impairments for RF: OFF ➤ Settings on analyzer <ul style="list-style-type: none"> FREQ CENTER measurement frequencies SPAN 0 Hz AMPT/REF LEVEL – 10 dBm BW /RES BW MANUAL 100 kHz ➤ Measure the frequency response at the measurement frequencies in I, IN, Q and QN and check the deviation. <p>Measurement frequencies: 1 MHz (reference), 3 MHz, 10 MHz, 25 MHz, 30 MHz, 35 MHz, 45 MHz, 55 MHz, 60 MHz for BBGEN Board Revision ≥ 05.00: additional 70MHz, 80MHz (up to the maximum modulation bandwidth of the baseband generator)</p>

IQ Output, Offset, Wideband Noise

Test equipment	Signal analyzer R&S FSQ (<i>Table 1-1</i> , item 19), Multimeter (<i>Table 1-1</i> , item 15)
Test setup	➤ Connect the signal analyzer to the I-output of the DUT.
Test method	First a reference measurement is performed with a DC Test-Waveform. and with the Frequency Offset of 10 MHz. Subsequently, the noise power (state off) is measured at 11 MHz.
Measurement	<ul style="list-style-type: none"> ➤ Settings on DUT <ul style="list-style-type: none"> Level: 0 dBm ARB: <ul style="list-style-type: none"> Load Waveform /var/smbv/Lists/PerfTest/Test_DC.wv State On Frequency Offset: 10 MHz ➤ Settings on analyzer <ul style="list-style-type: none"> FREQ CENTER 10 MHz SPAN 0 Hz AMPT/REF LEVEL 5 dBm BW /RES BW MANUAL 100 kHz MKR / MARKER 1 ➤ Measure carrier at 10 MHz (reference measurement) ➤ Settings on DUT <ul style="list-style-type: none"> State Off ➤ Settings on analyzer <ul style="list-style-type: none"> FREQ CENTER 11 MHz AMPT/REF LEVEL - 40 dBm AMPT/RF ATTEN MANUAL 0 dBm TRACE / DETECTOR RMS BW /SWEEP TIME MANUAL 50 ms MKR FCT / NOISE MEAS ➤ Measure the noise power at 11 MHz and calculate the wideband noise. <ul style="list-style-type: none"> Calculation: Wideband noise = noise power / reference value + 3 dB. (add +3 dB, as it is sine)
Test setup	➤ Connect the multi meter to the I and Q-output of the DUT.
Measurement	➤ Check offset

IQ Output, Spurious Free Dynamic Range (SFDR)

Note: Make sure that the measured spurious signal does not come from the analyzer. The following tests can be performed for this purpose:

- Switch off the signal from the DUT and repeat the measurement; if the signal remains, it may come from the analyzer.
- Output the signal from the DUT with a slight frequency offset; if the signal remains, it may come from the analyzer.

Test equipment	Signal analyzer R&S FSQ (Table 1-1 , item 19)
Test setup	➤ Connect the signal analyzer to the I- and subsequently to the IN, Q and QN-output of the DUT.
Test method	A single sideband signal is generated using a DC Test-Waveform. The test frequency is set with the Frequency Offset function in the Baseband menu. The next highest signal in the spectrum outside the carrier is measured.
Measurement	<p>➤ Settings on DUT Frequencies: 100 MHz Level: 0 dBm ARB: Load Waveform /var/smbv/Lists/PerfTest/Test_DC.wv State On Frequency Offset: test frequency</p> <p>Test frequencies: 2 MHz / 5 MHz / 10 MHz / 20 MHz for BBGEN Board Revision ≥ 05.00: additional 25 MHz</p> <p>➤ Settings on analyzer: FREQ CENTER: 31 MHz SPAN 60 MHz AMPT / REF LEVEL 5 dBm AMPT / RF ATTEN MANUAL 25 dB BW / RES BW MANUAL 300 kHz BW / SWEEP TIME MANUAL 50 ms TRACE / DETECTOR RMS MKR / MARKER 1 MKR -> / PEAK MKR / MARKER 2 MKR -> / NEXT PEAK</p> <p>➤ If a delta occurs, read off the spacing of the spurious signals on the R&S FSQ.</p>

Aliasing Filter – D/A Converter, Interpolation Spectra

Note: *Make sure that the measured spurious signal does not come from the analyzer. The following tests can be performed for this purpose:*

- *Switch off the signal from the DUT and repeat the measurement; if the signal remains, it may come from the analyzer.*
- *Output the signal from the DUT with a slight frequency offset; if the signal remains, it may come from the analyzer.*

Test equipment	Signal analyzer R&S FSQ (Table 1-1 , item 19).
Test setup	<ul style="list-style-type: none"> ➤ Connect the signal analyzer to the RF output of the DUT. ➤ Synchronize the reference frequencies of the DUT and the analyzer.
Test method	A single sideband signal is generated using a DC Test-Waveform. The test frequency is set with the Frequency Offset function in the Baseband menu. The level measured at the measurement frequency gives the value for the suppression of the interpolation.

<p>Measurement</p>	<ul style="list-style-type: none"> ➤ Settings on DUT <ul style="list-style-type: none"> RF On Frequency: 1 GHz Level: 0 dBm ARB: <ul style="list-style-type: none"> Load Waveform /var/smbv/Lists/PerfTest/Test_DC.wv State On Frequency Offset: test frequency ➤ Settings on analyzer: <ul style="list-style-type: none"> FREQ CENTER: measurement frequency SPAN 0 Hz AMPT / REF LEVEL - 10 dBm BW / RES BW MANUAL 30 kHz BW / SWEEP TIME MANUAL 200 ms TRACE / DETECTOR RMS MKR / MARKER 1 ➤ for BBGEN Board Revision < 05.00: <table style="width: 100%; border: none;"> <tr> <td style="width: 50%;">Test frequencies:</td> <td style="width: 50%;">Measurement frequencies:</td> </tr> <tr> <td>10.1 MHz</td> <td>860.1 MHz</td> </tr> <tr> <td>10.1 MHz</td> <td>1139.9 MHz</td> </tr> <tr> <td>39.9 MHz</td> <td>889.9 MHz</td> </tr> <tr> <td>39.9 MHz</td> <td>1110.1 MHz</td> </tr> <tr> <td>59.9 MHz</td> <td>909.9 MHz</td> </tr> <tr> <td>59.9 MHz</td> <td>1090.1 MHz</td> </tr> </table> for BBGEN Board Revision ≥ 05.00: <table style="width: 100%; border: none;"> <tr> <td style="width: 50%;">Test frequencies:</td> <td style="width: 50%;">Measurement frequencies:</td> </tr> <tr> <td>10.1 MHz</td> <td>810.1 MHz</td> </tr> <tr> <td>10.1 MHz</td> <td>1189.9 MHz</td> </tr> <tr> <td>39.9 MHz</td> <td>839.9 MHz</td> </tr> <tr> <td>39.9 MHz</td> <td>1160.1 MHz</td> </tr> <tr> <td>59.9 MHz</td> <td>859.9 MHz</td> </tr> <tr> <td>59.9 MHz</td> <td>1140.1 MHz</td> </tr> <tr> <td>79.9 MHz</td> <td>879.9 MHz</td> </tr> <tr> <td>79.9 MHz</td> <td>1120.1 MHz</td> </tr> </table> (Test frequencies up to the maximum modulation bandwidth of the baseband generator) 	Test frequencies:	Measurement frequencies:	10.1 MHz	860.1 MHz	10.1 MHz	1139.9 MHz	39.9 MHz	889.9 MHz	39.9 MHz	1110.1 MHz	59.9 MHz	909.9 MHz	59.9 MHz	1090.1 MHz	Test frequencies:	Measurement frequencies:	10.1 MHz	810.1 MHz	10.1 MHz	1189.9 MHz	39.9 MHz	839.9 MHz	39.9 MHz	1160.1 MHz	59.9 MHz	859.9 MHz	59.9 MHz	1140.1 MHz	79.9 MHz	879.9 MHz	79.9 MHz	1120.1 MHz
Test frequencies:	Measurement frequencies:																																
10.1 MHz	860.1 MHz																																
10.1 MHz	1139.9 MHz																																
39.9 MHz	889.9 MHz																																
39.9 MHz	1110.1 MHz																																
59.9 MHz	909.9 MHz																																
59.9 MHz	1090.1 MHz																																
Test frequencies:	Measurement frequencies:																																
10.1 MHz	810.1 MHz																																
10.1 MHz	1189.9 MHz																																
39.9 MHz	839.9 MHz																																
39.9 MHz	1160.1 MHz																																
59.9 MHz	859.9 MHz																																
59.9 MHz	1140.1 MHz																																
79.9 MHz	879.9 MHz																																
79.9 MHz	1120.1 MHz																																

Bias voltage (only for BBGEN Board Revision \geq 05.00)

Test equipment	Multimeter (Table 1-1 , item 15).
Test setup	➤ Connect the multimeter to the I/(and Q)-output of the DUT.
Test method	The bias voltage is measured for different values.
Measurement	<ul style="list-style-type: none"> ➤ Settings on DUT I/Q Out Settings: I/Q Output Type: Single Ended Mode: Variable I/Q Level Vp (EMF): 0.1 V Couple I/Q Bias: On Bias EMF: measurement bias ➤ Settings on multimeter COUPLING DC
Measurement	➤ Check bias: -3.6, -1, -0.3, -0.1, -0.03, -0.01, 0, +0.002, 1 and 3.6 V

Offset voltage (only for BBGEN Board Revision \geq 05.00)

Test equipment	Multimeter (Table 1-1 , item 15).
Test setup	➤ Connect the multimeter to the I and I Bar (Q and Q Bar)-output of the DUT.
Test method	The I and I Bar (or Q and Q Bar) voltage are measured for different offset values. The differential offset is obtained from the differences between I and I Bar (or Q and Q Bar) at a particular offset.
Measurement	<ul style="list-style-type: none"> ➤ Settings on DUT I/Q Out Settings...: I/Q Output Type: Differential Mode: Variable I/Q Level Vp (EMF): 1 V Couple I/Q Bias: On Bias EMF: 0 V Offset EMF: measurement offset ➤ Settings on multimeter COUPLING DC
Measurement	➤ Check offset : -300, -150, -30, -10, -3, -1, 0, +0.1, 30, 150 and 300 mV

Function External Clock

The equipment layout for generating Custom Digital Mod signals includes the options R&S SMBV-B10 (baseband generator).

Test equipment	Vector Signal Generator DUT (Table 1-1 , item 5) , Signal Analyzer R&S FSQ with option R&S FSQ-K70 (vector signal analysis).
Test setup	<ul style="list-style-type: none">➤ Connect CLOCK outputs of reference DUT to CLOCK inputs of test DUT (DUT).➤ Connect signal analyzer to RF output of DUT
Test method	The test DUT is supplied with a clock from the reference DUT via the external interface. The modulated signal is extracted at the RF output of the DUT, demodulated with the R&S FSQ and checked for EVM.

Measurement	<ul style="list-style-type: none"> ➤ Settings on DUT <ul style="list-style-type: none"> Frequency: 100 MHz Level: 0 dBm Custom Digital Mod: <ul style="list-style-type: none"> State ON Data Source Pattern 010101010101 Modulation Type 8PSK Symbol Rate 20MHz Filter RRC (Root-Raised-Cosine) Roll off 0.22 Clock <ul style="list-style-type: none"> Source: External Mode: Multiple Symbol Multiplier: 5 Global Settings <ul style="list-style-type: none"> Threshold Data Input 50Ohm Impedance Data Input 1.5V ➤ Settings on reference-DUT <ul style="list-style-type: none"> Frequency: 100 MHz Level: 0 dBm ARB <ul style="list-style-type: none"> Load Waveform any State ON Clock Freq 100 MHz ➤ Check external clock rate (Measured Extern Clock in Trigger-Marker-Clock menu) - must be 100 MHz. ➤ Settings on analyzer: <ul style="list-style-type: none"> VSA FREQ CENTER: 100 MHz AMPT / REF LEVEL 5 dBm MODULATION SETTINGS <ul style="list-style-type: none"> SYM RATE 20 MHz MODULATION & MAPPING PSK 8PSK MODULATION FILTER RRC RRC RRC RRC ALPHA BT 0.22 ➤ Check EVM in Modulation Accuracy Table.
-------------	---

Function Level Attenuation

The equipment layout for generating GSM/EDGE signals includes the options R&S SMBV-B10 (baseband generator) and R&S SMBV-K40 (Digital Standard GSM/EDGE).

Test equipment	Signal analyzer (Table 1-1 , item 19) with options R&S FSQ-K70 (Vector Signal Analysis) and R&S FS-K5 (GSM/EDGE Measurements).
Test setup	➤ Connect signal analyzer to RF output of DUT.
Measurement	<ul style="list-style-type: none"> ➤ Settings on DUT: <ul style="list-style-type: none"> Frequency: 450 MHz Level: 0 dBm GSM/EDGE: <ul style="list-style-type: none"> State ON Define All Slot Attenuations <ul style="list-style-type: none"> A1 0 dB A2 10 dB A3 20 dB A4 30 dB A5 40 dB A6 50 dB Slot 0 <ul style="list-style-type: none"> Slot Level Attenuated Slot Attenuation 0 dB (A1) ➤ Settings on analyzer <ul style="list-style-type: none"> VSA FREQ CENTER 450 MHz DIGITAL STANDARD GSM/EDGE GSM NB ADJUST REF LVL ➤ Read off the level of the signal in the Modulation Accuracy table at mean power and write it down as the reference level. ➤ On the DUT, set the level attenuation of slot 0 in sequence to 10 dB (A2) to 50 dB (A6) (see above). ➤ Settings on analyzer (for each level attenuation settings) <ul style="list-style-type: none"> ADJUST REF LVL ➤ Each time, measure the level again relative to the reference level. <ul style="list-style-type: none"> ⇒ The additional level error in question is the difference of the level difference measured to the level difference set. ➤ Recommended test frequencies <ul style="list-style-type: none"> 900 MHz, 1.8 GHz, 5 GHz.

BNC Connectors

Test equipment	several BNC cable
Test setup	Make the following BNC connections on the instrument: from: to: MARKER1 TRIG MARKER2 NEXT CLK OUT CLK IN
Test method	Self-test by means of connection test
Measurement	<ul style="list-style-type: none"> ➤ Settings on DUT Custom Digital Mod: State ON (the markers are available in this state only) ➤ Start selftest BNC via remote control with commands TEST:BB:CONN?

DIGITAL IQ IN/OUT Connector

Test equipment	<ul style="list-style-type: none"> ➤ Signal generator (Table 1-1, item 5), equipped with Digital Input (B17) and Digital Output (B18) ➤ Cable for Digital-Baseband IO (Table 1-1, item 23),
Test setup	<ul style="list-style-type: none"> ➤ 1. Connect signal generator's Digital Input to the DIGITAL IQ IN/OUT of the DUT with the Mini D Ribbon cable. ➤ 2. Connect signal generator's Digital Output to the DIGITAL IQ IN/OUT of the DUT with the Mini D Ribbon cable.
Test method	<ol style="list-style-type: none"> 1. Set the Digital Output of the DUT(Sender) in test sequence transmitting mode. The signal generator's Digital Input (Receiver) evaluates the incoming test pattern and calculates the Bit Error Rate. 2. Set the Digital Output of the signal generator (Sender) in test sequence transmitting mode. The DUT's Digital Input (Receiver) evaluates the incoming test pattern and calculates the Bit Error Rate.
Measurement	<ul style="list-style-type: none"> ➤ Settings on Sender: Activate test sequence transmitting via remote control with command: TEST<HW>:BBOut:TTEST ON ➤ Settings on Receiver: Start bit error evaluation via remote control with command: :TEST<HW>:BBIN:RBERror? Result: 0 = TestOk, 1 = TestFailed <p>Test will take 2 seconds to deliver a result. Repeat it 3 times, all of the test results must be OK.</p> <ul style="list-style-type: none"> ➤ Settings on Sender Deactivate test sequence transmitting via remote control with command: TEST<HW>:BBOut:TTEST OFF

GSM and GSM Normal Burst

The equipment layout for generating GSM/EDGE signals includes the options R&S SMBV-B10 (baseband generator) and R&S SMBV-K40 (Digital Standard GSM/EDGE).

Test equipment	Signal analyzer R&S FSQ including options R&S FSQ-K70 (Vector Signal Analysis) and R&S FS-K5 (GSM/EDGE) (Table 1-1 , item 19)
Test setup	➤ Connect signal analyzer to RF output of DUT.
Measurement method	<ol style="list-style-type: none"> 1. Set Custom Dig Mod in the baseband; set standard GSM here. Perform the measurements with the GSM measurement setting of the R&S FSQ. 2. Set standard GSM in the baseband. Perform the measurements with the GSM measurement setting of the R&S FSQ.
Measurement 1	<ul style="list-style-type: none"> ➤ Settings on DUT <ul style="list-style-type: none"> Level: +18 dBm Frequencies: 910 MHz, 1850 MHz and 5GHz for R&S SMBV-B106 Custom Digital Mod: <ul style="list-style-type: none"> State ON Set acc. To Standard: GSM ➤ Settings on analyzer <ul style="list-style-type: none"> VSA FREQ CENTER: 910 MHz, 1850 MHz (and 5 GHz for DUT-B106) DIGITAL STANDARD GSM/EDGE GSM_NB ADJUST REF LVL ➤ Check phase error in Modulation Accuracy Table ➤ Settings on analyzer <ul style="list-style-type: none"> FREQ CENTER: 910 MHz, 1850 MHz and 5 GHz for R&S SMBV-B106 MEAS CHAN PWR ACP CP /ACP CONFIG <ul style="list-style-type: none"> NO. OF ADJ CHAN 3 CHANNEL BANDWIDTH 30 kHz (all entries) CHANNEL SPACING 200 kHz (all entries) ADJUST SETTINGS MEAS CHAN PWR ACP ADJUST REF LVL NOISE CORR ON ➤ Check ACP (take the smaller of the two measurement values UPPER/LOWER in each case): <ul style="list-style-type: none"> Adjacent Channel, Alternate Channel, 2nd Alternate Channel

Measurement 2	<ul style="list-style-type: none">➤ Settings on DUT:<ul style="list-style-type: none">Level: +18 dBm PEPFrequencies: 910 MHz, 1850 MHz and 5 GHz for R&S SMBV-B106GSM/EDGE:<ul style="list-style-type: none">State ON ➤ Settings on analyzer<ul style="list-style-type: none">GSM/EDGEFREQ CENTER 910 MHz, 1850 MHz and 5 GHz for R&S SMBV-B106GSM/EDGEDEMOD SETTINGSAUTO LEVEL&TIMEGSM/EDGEPOWER VS TIMESTART REF MEAS.<p>LIMIT CHECK PASSED has to be indicated on the analyzer.</p> ➤ Settings on analyzer<ul style="list-style-type: none">GSM/EDGETRANSIENT SPECTRUMSTART REF MEAS<p>LIMIT CHECK PASSED has to be indicated on the analyzer.</p> ➤ Settings on analyzer<ul style="list-style-type: none">GSM/EDGEMODULATION SPECTRUMSTART REF MEAS<p>LIMIT CHECK PASSED or MARG has to be indicated on the analyzer.</p>
---------------	---

GSM Edge and GSM Edge Burst

The equipment layout for generating GSM/EDGE signals includes the options R&S SMBV-B10 (baseband generator) and R&S SMBV-K40 (Digital Standard GSM/EDGE).

Test equipment	Signal analyzer R&S FSQ including options R&S FSQ-K70 (Vector Signal Analysis) and R&S FS-K5 (GSM/EDGE) (Table 1-1 , item 19)
Test setup	➤ Connect signal analyzer to RF output of DUT.
Measurement method	<ol style="list-style-type: none"> 1. Set Custom Dig Mod in the baseband; set standard GSM EDGE here. Perform the measurements with the GSM EDGE measurement setting of the R&S FSQ. 2. Set standard GSM/EDGE in the baseband. Perform the measurements with the GSM EDGE measurement setting of the R&S FSQ.
Measurement 1	<ul style="list-style-type: none"> ➤ Settings on DUT <ul style="list-style-type: none"> Level: +13 dBm PEP Frequencies: 910 MHz, 1850 MHz and 5GHz for R&S SMBV-B106 Custom Digital Mod: <ul style="list-style-type: none"> State ON Set acc. To Standard: GSM EDGE ➤ Settings on analyzer <ul style="list-style-type: none"> VSA FREQ CENTER: 910 MHz, 1850 MHz and 5 GHz for R&S SMBV-B106 DIGITAL STANDARD GSM-EDGE EDGE_NB ADJUST REF LVL ➤ Check EVM in Modulation Accuracy Table ➤ Settings on analyzer <ul style="list-style-type: none"> FREQ CENTER: 910 MHz, 1850 MHz and 5 GHz for R&S SMBV-B106 MEAS CHAN PWR ACP CP /ACP CONFIG <ul style="list-style-type: none"> NO. OF ADJ CHAN 3 CHANNEL BANDWIDTH 30 kHz (all entries) CHANNEL SPACING 200 kHz (all entries) ADJUST SETTINGS MEAS CHAN PWR ACP ADJUST REF LVL NOISE CORR ON ➤ Check ACP (take the smaller of the two measurement values UPPER/LOWER in each case): <ul style="list-style-type: none"> Adjacent Channel, Alternate Channel, 2nd Alternate Channel

Measurement 2	<ul style="list-style-type: none">➤ Settings on DUT: Level: +13 dBm Frequencies: 910 MHz, 1850 MHz and 5 GHz for R&S SMBV-B106 GSM/EDGE: State ON Slot 0 Burst Type Edge ➤ Settings on analyzer GSM/EDGE FREQ CENTER 910 MHz, 1850 MHz and 5 GHz for R&S SMBV-B106 GSM/EDGE DEMOD SETTINGS MODULATION EDGE AUTO LEVEL&TIME GSM/EDGE POWER VS TIME START REF MEAS LIMIT CHECK PASSED has to be indicated on the analyzer. ➤ Settings on analyzer GSM/EDGE TRANSIENT SPECTRUM START REF MEAS LIMIT CHECK PASSED has to be indicated on the analyzer. ➤ Settings on analyzer GSM/EDGE MODULATION SPECTRUM START REF MEAS LIMIT CHECK PASSED or MARG has to be indicated on the analyzer.
---------------	--

Modulation error for WCDMA - 3GPP

The equipment layout for generating digital modulation signals includes the options R&S SMBV-B10 (baseband generator).

Test equipment	Signal analyzer R&S FSQ including option R&S FSQ-K70 (Vector Signal Analysis) (Table 1-1 , item 19)
Test setup	➤ Connect signal analyzer to RF output of DUT.
Test method	Set Custom Dig Mod to standard WCDMA-3GPP in the baseband. Perform the measurements with the 3GPP measurement setting of the R&S FSQ.
Measurement	<ul style="list-style-type: none"> ➤ Settings on DUT <ul style="list-style-type: none"> Level: +8.19 dBm (13 dBm PEP) Frequencies: 2160 MHz Custom Digital Mod: <li style="padding-left: 20px;">State ON <li style="padding-left: 20px;">Set acc. To Standard: WCDMA-3GPP ➤ Settings on analyzer <ul style="list-style-type: none"> VSA FREQ CENTER: 2160 MHz (and 5GHz for R&S SMBV-B106) DIGITAL STANDARD 3G-WCDMA 3G WCDMA_FWD ADJUST REF LVL ➤ Check EVM in Modulation Accuracy Table

Digital Standards

GPS (R&S SMBV-K44)

There is no testing required for the GPS (R&S SMBV-K44) software personality. The functions required for this personality are already verified performing the tests defined in chapter "[Internal Baseband Generator](#)".

3GPP FDD HSUPA (R&S SMBV-K45)

There is no testing required for the 3GPP FDD HSUPA (R&S SMBV-K45) software personality. The modulation error and adjacent channel power tests are already done when testing the 3GPP FDD option in chapter "[Internal Baseband Generator](#)".

CDMA2000 (R&S SMBV-K46)

There is no testing required for the CDMA2000 (R&S SMBV-K46) software personality. The modulation error and adjacent channel power tests are already done when testing the 3GPP FDD option in chapter "[Internal Baseband Generator](#)".

WLAN 802.11 a, b, g (R&S SMBV-K48)

There is no testing required for the WLAN 802.11 a, b, g (R&S SMBV-K48) software personality. The functions required for this personality are already verified performing the tests defined in chapter "[Internal Baseband Generator](#)".

WiMAX 802.16-2004 (R&S SMBV-K49)

There is no testing required for the WiMAX 802.16-2004 (R&S SMBV-K49) software personality. The functions required for this personality are already verified performing the tests defined in chapter "[Internal Baseband Generator](#)".

TD-SCDMA (R&S SMBV-K50)

There is no testing required for the TD-SCDMA (R&S SMBV-K50) software personality. The functions required for this personality are already verified performing the tests defined in chapter "[Internal Baseband Generator](#)".

TD-SCDMA enhanced BS/MS Tests (R&S SMBV-K51)

There is no testing required for the TD-SCDMA enhanced BS/MS Tests (R&S SMBV-K51) software personality. The functions required for this personality are already verified performing the tests defined in chapter "[Internal Baseband Generator](#)".

Additive White Gaussian Noise (R&S SMBV-K62)

Test equipment	Signal analyzer R&S FSQ (Table 1-1 , item 19)
Test setup	<ul style="list-style-type: none"> ➤ Connect signal analyzer to RF output of DUT.
Test method	<p>A digital modulated signal is generated and noise is added. Using the channel power measurement facility of the spectrum analyzer, the carrier power and the power of a section of the noise spectrum is determined. By expanding the result to the system bandwidth, the carrier to noise ratio can be reconstructed.</p> <p>The noise generator is a firmware option, realized in a FPGA. The functionality of this FPGA is tested with one measurement, data are guaranteed by design.</p>
Measurement	<ul style="list-style-type: none"> ➤ Settings on DUT <ul style="list-style-type: none"> Level: 0 dBm Frequency: 1 GHz RF: State ON ➤ Settings on DUT if Unicod is installed <ul style="list-style-type: none"> Baseband Custom Digital Modulation Set to default (GSM), Symbol Rate 500 Hz State on AWGN/IMP AWGN Additive Noise, System Bandwidth 1 MHz Carrier/Noise Ratio 20.00 dB State ON ➤ Settings on analyzer <ul style="list-style-type: none"> FREQ CENTER: 1 GHz MEAS CHAN PWR ACP CP /ACP CONFIG CHANNEL BANDWIDTH 100 kHz AMPT REF LEVEL 10 dBm BW RES BW MANUAL 30 kHz VIDEO BW MANUAL 300 kHz TRACE DETECTOR RMS SWEEP SWEEP TIME MANUAL 2 sec ➤ Measure carrier power and denote as a reference. ➤ Settings on DUT if Unicod is not installed <ul style="list-style-type: none"> AWGN/IMP AWGN Noise only, System Bandwidth 1 MHz Noise Level -20.00 dB State ON ➤ Now retune center frequency of the analyzer to 1.0003 GHz. ➤ Measure the noise power. ➤ Since the measurement bandwidth is a tenth of the system bandwidth, the result is to be corrected by 10 dB. <p>⇒ The result is carrier power – noise power – 10 dB.</p>

Hardware Signals

SIGNAL VALID

Test equipment	- Spectrum analyzer (Table 1-1 , item 19)
Test setup	➤ Apply connection from the SIGNAL VALID socket on the rear of the DUT to external trigger input of the spectrum analyzer.
Test method	The function of the Signal is tested by triggering the spectrum analyzer.
Measurement	<ul style="list-style-type: none">➤ Setting on DUT:<ul style="list-style-type: none">- Frequency: 100 MHz ➤ Settings on spectrum analyzer:<ul style="list-style-type: none">- TRIGGER EXTERN- External triggering by negative edge at 1.4 V. ➤ Change DUT Frequency to 1 GHz➤ Check trigger on analyzer.

Phase Coherence (Option R&S SMBV-B90)

Test assembly	The RF output of the second Signal generator (<i>Table 1-1</i> , item 5) is connected to the LO IN-connector and the power meter (<i>Table 1-1</i> , item 8) is connected to LO OUT-connector of the DUT.
Test method	A LO-Signal from the second signal generator is fed into the LO input of the DUT. With LO-Coupling set to external and the LO-output switched on the power at the LO-out SMA-connector of the DUT is measured with the power meter. The limiting amplifier in the LO IN signal path as well as the amplifier driving the LO out port can so be measured together.
Measurement	<ul style="list-style-type: none"> ➤ Settings on DUT: <ul style="list-style-type: none"> RF: State ON Level: -30 dBm Frequency: 1 GHz I/Q Settings menu: <ul style="list-style-type: none"> Source Analog Wideband I/Q Input State On LO Coupling menu <ul style="list-style-type: none"> Mode External Out State On ➤ Setting on second signal generator: <ul style="list-style-type: none"> - Level: + 7 dBm - Frequency: recommended test frequencies - RF: State ON ➤ Measure the level $P_{+7\text{ dBm}}(f)$ setting the frequency f of the second generator to the recommended test frequencies. Set the level of the second signal generator to +13 dBm and measure the level $P_{+13\text{ dBm}}(f)$ setting the frequency f of the second generator to the recommended test frequencies. <ul style="list-style-type: none"> ⇒ The level $P_{+7\text{ dBm}}(f)$ and $P_{+13\text{ dBm}}(f)$ should be $+10\text{ dBm} \pm 3\text{ dB}$ ⇒ The level difference between $P_{+13\text{ dBm}}(f)$ and $P_{+7\text{ dBm}}(f)$ should be less than $\pm 1\text{ dB}$ for all frequencies f.
Recommended test frequencies Phase-Coherence measurement	From 200 MHz every 100 MHz up to RFmax

Contents - Chapter 2 "Procedures after Module Replacement"

- 2 Procedures after Module Replacement.....2.1**
 - Procedures after Replacing the Lithium Battery2.2**
 - Procedures after Replacing the Basis Board2.2**
 - Adjustments2.2**
 - Internal Adjustments2.2
 - Adjustments of the Complete Unit.....2.2
 - External Level Correction2.2
 - Adjustment of internal Reference Frequency.....2.3
 - Recalibration2.3
 - Internal Self Test.....2.3**

2 Procedures after Module Replacement

This chapter describes all necessary measures to restore the performance of the R&S SMBV after module replacement.

There are no manual adjustments to be performed. Internal and external adjustment routines are implemented for this purpose.

Spare part RF boards, Vector boards and BBGEN boards are tested at Rohde & Schwarz with calibrated working standards according to the performance test. All measurement values are within the specified values including the measurement uncertainty as a minimum guard band.

Oupit power levels of the RF board are corrected to be within the guaranteed values. When installing a spare part RF board the only difference at the RF side is the connecting cable between the RF board and the front panel. When testing the RF boards Rohde & Schwarz uses the same type of cable as it is installed in the R&S SMBV.

OCXOs are tested at Rohde & Schwarz for the frequency adjustment range and the control voltage for an exact 10 MHz output frequency. This control voltage is coded in a digital value and stored on the OCXO module. In the R&S SMBV the digital value is read from the OCXO module.

The probability that the R&S SMBV meets its specifications after the replacement of a RF board and / or an OCXO is very high. To increase this probability even further and to detect a defective connecting cable between the RF board and the front panel Rohde & Schwarz recommends to adjust and to verify the power level and the reference frequency according to the instructions in the table below.

If a calibration of the instrument is strictly necessary the performance test should be performed completely.

After replacing assemblies always run the internal selftest which has to finish successfully, additionally check the following table to see which service procedure you perform.

Changed module	Required adjustment/correction	Recommended Test Procedure (refer to chapter 1 Performance Test "Checking the rated characteristics")
Basis Board	Setup/Internal Adjustments/Adjust All set correct time and date, see below.	None
RF Board	Setup/Internal Adjustments/Adjust All External Level Correction (NRP-Z91 or NRP-Z92 power sensor required)	Level Data at 0 dBm
B1 OCXO	Setup/Internal Adjustments/Adjust All	Reference Frequency "Output of Internal Reference"
Vector Board	Setup/Internal Adjustments/Adjust All	I/Q-modulation "Input Impedance" and "Error Vector" If Option R&S SMBV-B90 is installed check Phase Coherence
BBGEN board	Setup/Internal Adjustments/Adjust All	GSM and GSM Normal Burst and Modulation Error for WCDMA-3GPP
LI Bridge	Setup/Internal Adjustments/Adjust All	None
Power Supply	Setup/Internal Adjustments/Adjust All	None
Front unit	External Level Correction (R&S NRP-Z91 or R&S NRP-Z92 power sensor required)	Level Data at 0 dBm
Hard Disk	New hard disks have to be formatted first. See Manual.	None

Procedures after Replacing the Lithium Battery

1. Connect an USB keyboard to the R&S SMBV.
2. Switch on the R&S SMBV. The operating system (LINUX) and the R&S SMBV firmware will start.
3. Set correct date and time at R&S SMBV setup menu.

Procedures after Replacing the Basis Board

Required equipment

USB Memory Stick (at least 128 MB)

Required software:

SMBV Firmware, available at R&S homepage www.rohde-schwarz.com/product/smbv

Copy the firmware to the root folder of the memory stick.

Install the Firmware

See Chapter 4 "Software Update".

Adjustments

Preliminary Remark

Setting a defined initial state by pressing the **PRESET** key prior to adjustments is recommended. To ensure that the internal adjustments are valid at operating temperature, at least **20 minutes warm-up time** at this temperature must be observed.

Internal Adjustments

All internal adjustments are available in the **Setup/Internal Adjustments** menu (see operating manual).

Adjustments of the Complete Unit

Performing **Setup/Internal Adjustments/Adjust All** activates all internal adjustments in a reasonable order.

External Level Correction

The external level adjustment has to be performed, if the RF board or the Front Unit has been replaced.

The measuring program for external level correction measures output power over frequency and level and stores the correction values inside the R&S SMBV to maintain level accuracy.

Adjustment of internal Reference Frequency

The frequency accuracy of the synthesizer is determined (set to internal reference) by a 200 MHz VTCXO or when the Option R&S SMBV-B1 is fitted with a highly stable OCXO that is set to a calibrated frequency standard at the R&S factory. This oscillator is subject to ageing and can be recalibrated.

Recalibration

Important: Allow the DUT to warm up for at least 20 minutes before adjustment is executed

- | | |
|----------------|--|
| Test equipment | - External frequency counter (1 Hz to RF _{max} , resolution 0.1 Hz) |
| Test setup | ➤ Connect a calibrated external frequency counter to the reference output at the rear panel. |
| Adjustment | ➤ Setting on DUT: |
- PRESET**
- Setup Menu
- Protection
- Protection Level 2 = 147946 ENTER
- Setting on spectrum analyzer (external frequency counter):
- MKR SIGNAL COUNT**
- MKR / NEXT CNT RESOL 0.1 Hz**
- Adjust the TCXO/ OCXO Calibration Value (Setup - Reference Oscillator - Calibration Value) for an external frequency counter reading of 10 MHz, with minimal error.
- Press Write **value to Eeprom** to store the DAC value.

Internal Self Test

After each module replacement, it is recommended to perform the internal self test (refer to chapter 3, "Troubleshooting with Internal Self Test"). The self test checks the instrument by measuring internal diagnostic points and verifies whether generator is operating properly.

If a self test failure occurs, check again whether all cables are properly connected. If the self test fails continuously, contact your local service center.

Contents – Chapter 3 "Repair"

3 Repair	3.1
Instrument Design and Function Description	3.1
RF Board	3.3
Internal and external 10 MHz reference	3.4
TCXO 200 MHz crystal oscillator	3.4
RF Synthesizer/ DDS module	3.4
Harmonics filters	3.4
LF generator	3.4
Pulse Generator and Pulse Modulator	3.4
Modulation matrix and AM/FM/φM modulator	3.5
Automatic Level control	3.5
Step Attenuator and reverse power protection	3.5
Supply voltage control and filtering	3.5
Power Supply Module	3.5
Basis Board 2 and 4	3.6
Fuses	3.7
Switching regulators	3.7
Controller	3.8
FPGA (SMB_COM)	3.8
SIM Card	3.8
Keyboard Controller	3.8
Diagnostic ADC	3.8
EEPROM	3.8
Temperature sensor	3.9
Fan Controller	3.9
Vector Board	3.9
Control Logic and Flash PROM	3.10
Supply voltage regulators	3.10
LO switch	3.10
Baseband	3.10
I/Q modulator ASIC	3.10
RF path	3.11
Down converter	3.11
1200 MHz LO and clock generation	3.11
Level control circuit	3.11
BBGEN Board	3.12
LI Bridge	3.12
Troubleshooting	3.13
Measuring Equipment and Accessories	3.13
Switch-On Problems	3.14
Switch-on	3.14
Switch-off	3.15
Problems with Booting	3.18
Keyboard and Rotary Knob Test	3.19
USB Cable Test	3.19
Troubleshooting using Internal Selftest	3.20
Troubleshooting using Internal Test Points	3.21
Troubleshooting using Internal Adjustments	3.24
Instrument Faults	3.25

Checking signals between RF Board and Vector Board.....	3.31
200 MHz reference and level control signal from RF Board to Vector Board.....	3.31
LO synthesizer signal from RF Board to Vector Board.....	3.32
RFMOD: I/Q modulated signal from Vector Board to RF Board.....	3.33
Troubleshooting – Basis Board Module and Power Supply.....	3.35
Supply Voltages	3.35
Fuses	3.36
Troubleshooting – RF Board module	3.38
Supply Voltages	3.38
Control Signals.....	3.39
Input and Output Signals	3.41
Error Messages concerning the RF Board Module	3.41
Warnings concerning the RF Board Module.....	3.42
Frequency error	3.43
Troubleshooting Vector Board	3.44
Vector Board self diagnosis run shows errors on supply voltage(s).....	3.45
Troubleshooting BBGEN-Board.....	3.46
Supply Voltages	3.46
Supply Voltages for the FPGA.....	3.47
Faulty Signal Generation in the Baseband	3.48
Troubleshooting LI Bridge	3.48
Troubleshooting – Reference Oscillator option R&S SMBV-B1/-B1H.....	3.49
Input and Output Signals	3.49
Error Messages Concerning the Reference Oscillator Module	3.50
Frequency Error, Reference Oscillator Adjustment.....	3.50
Module Replacement	3.51
Required tools.....	3.51
Overview of the Modules.....	3.51
After replacing an assembly.....	3.53
Safety Instructions.....	3.54
Dismounting the housing.....	3.55
Mounting the housing.....	3.55
Replacing Fuses	3.56
Installing Fuse	3.56
Replacing the Front Unit	3.57
Removing the Front Unit.....	3.57
Installing the Front Unit.....	3.60
Replacing the TFT Display, Encoder Board, USB Hub Board, Flex. Switchboard, Pushbutton Board Set and the Screened Filter Glass.....	3.63
Removing the TFT Display, Flex. Switchboard and Pushbutton Board Set, Screened Filter Glass, Encoder Board, USB 2.0 Hub Board.....	3.65
Installing the TFT Display, Flex. Switchboard and Pushbutton Board Set, Screened Filter Glass, Encoder Board and the USB 2.0 Hub Board	3.69
Replacing the R&S SMBV-B92 Hard Disc.....	3.73
Removing the R&S SMBV-B92 Hard Disc.....	3.73
Installing the R&S SMBV-B92 Hard Disc.....	3.73
Replacing the R&S SMBV-B90 Phase Coherence.....	3.74
Removing the R&S SMBV-B90 Phase Coherence	3.74
Installing the R&S SMBV-B90 Phase Coherence	3.75
Replacing the R&S SMBV-B10/-B50/-B51 Baseband Generator.....	3.77
Removing the R&S SMBV-B10/-B50/-B51 Baseband Generator	3.77
Installing the R&S SMBV-B10/-B50/-B51 Baseband Generator.....	3.77

Replacing the Vector Board	3.78
Removing the Vector Board.....	3.78
Installing the Vector Board.....	3.79
Replacing the Basis Board.....	3.80
Removing the Basis Board	3.80
Installing the Basis Board	3.83
Replacing the SIM Card.....	3.86
Replacing the RF Board.....	3.88
Removing the RF Board	3.88
Installing the RF Board	3.89
Replacing the Power Supply	3.91
Removing the Power Supply	3.91
Installing the Power Supply	3.93
Replacing the Fan Unit.....	3.95
Removing the Fan Unit	3.95
Installing the Fan Unit	3.96
Replacing the Li Bridge	3.96
Removing the Li Bridge.....	3.96
Installing the Li Bridge.....	3.98
Replacing the Battery.....	3.100
Replacing the R&S SMBV-B1/-B1H Reference Oscillator.....	3.102
Removing the R&S SMBV-B1/-B1H Reference Oscillator.....	3.102
Installing the R&S SMBV-B1/-B1H Reference Oscillator	3.102

3 Repair

Instrument Design and Function Description

A schematic of the signal generator's design is presented below as block diagram at module level

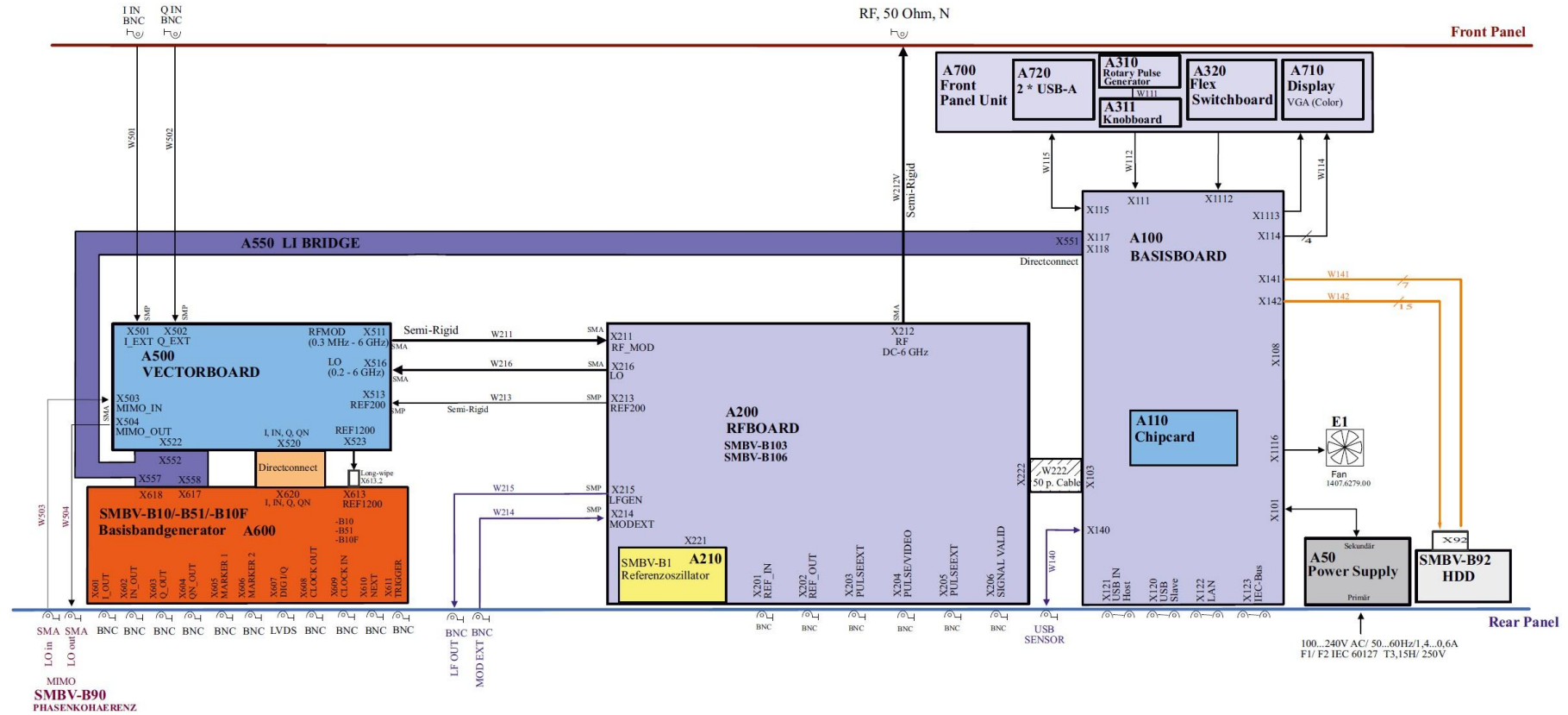

The R&S SMBV consists of few main modules and few connections between these modules. The main units are:

- Power Supply (A50)
- Basis Board (A100) which includes all digital external Interfaces, the main CPU, the Fan control logic, the hardware drivers for the front panel and the Interface for RF Board, Vector Board and BBGEN.
- Front Unit (A700) consisting of the rotary knob with encoder, the flexible switch board and the VGA Color Display
- RF Board (A200) including the whole measurement hardware for CW, AM, FM, PhiM and pulse-modulation.
- Vector Board (A500) including the vector modulator, down-converter and leveling unit for I/Q-modulation.
- BBGEN (A600) including the digital baseband generator and ARB
- LI BRIDGE (A550) passive board to connect Vector Board and BBGEN to the Basis Board and to each other.
- R&S SMBV-B1/-B1H Reference Oscillator (A210) which is plugged direct into the RF Board.
- R&S SMBV-B92 Hard Disc for long ARB sequences.

A detailed description of these modules is given in the next chapter.

RF Board

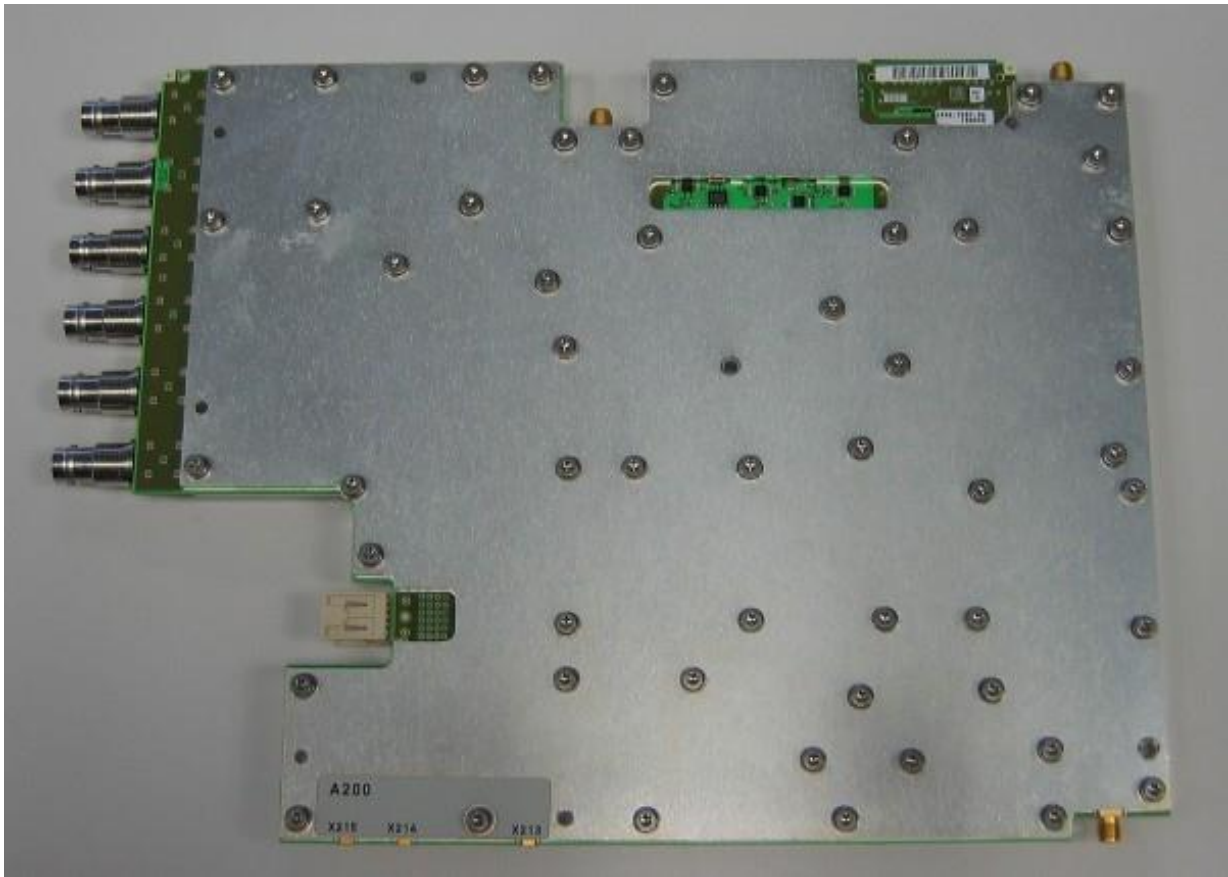

The RF Board contains the complete measuring hardware of the instrument. The RF and LF signals are generated and modulated on the module. The output level is controlled by a level control loop controlling the level before the step attenuator. The fully electronic step attenuator is temperature compensated to achieve very precise output levelling of the instrument. The RF Board is equipped with a reverse power protection to ensure the instrument not being damaged due to supplying reverse power to the RF output of the instrument. The module is controlled by the Basis Board via a serial bus and few additional control signals.

Implemented functions:

- Reference crystal oscillator and reference frequency switch
- Synthesizer
- LF generator
- Pulse generator and Pulse modulator control
- Modulation matrix
- DDS module including AM/FM/φM modulator
- AM modulator
- Harmonics filter
- Pulse modulator
- RF amplifiers
- Level control
- Step Attenuator
- Reverse power protection
- Diagnostics

Internal and external 10 MHz reference

The instrument's reference frequency is determined either by the signal supplied by the built-in OCXO (A210 reference oscillator) or by an external 10 MHz reference signal that is fed to the input X201 REFIN. The output X202 REFOUT provides a buffered 10 MHz signal, which has been derived from the active reference source. In internal reference mode, the frequency of the OCXO can be adjusted by a DAC.

TCXO 200 MHz crystal oscillator

A built-in 200 MHz TCXO delivers the internal reference signal for the DDS based Synthesizer and LF generator. This TCXO is synchronized to the selected 10 MHz reference signal (internal OCXO or external applied signal) with a PLL.

RF Synthesizer/ DDS module

The 200 MHz signal of the TCXO provides the system clock for the DDS module. The RF output frequencies from 9 kHz to 23.4375 MHz are generated directly by the DDS. In this mode all the modulation is done fully digital. The modulated signal is converted to the analog domain by a DAC. The analog RF signal is then low pass filtered, amplified and fed to the input of the step attenuator.

For set frequencies above 23.4375 MHz the DDS generates a signal with high resolution, that is upconverted with the 200 MHz Signal from the TCXO and then applied as reference signal to the main PLL of the RF frequency synthesizer. In the synthesizer a VCO is locked to the reference frequency using a fractional-n-PLL. The VCO output signal is then fed to fixed frequency dividers which are set to appropriate divider ratios to generate the RF signal from 23.4375 MHz to 2.2 GHz.

Harmonics filters

The output signal of the frequency dividers is a square wave signal. To reach the guaranteed harmonic performance (see datasheet) the harmonics of the RF signal have to be suppressed. Due to the wide RF frequency range multiple filters are needed. The different filters are selected according to the RF output frequency and their cut off frequency. They are put into the RF signal path by the means of RF switches.

LF generator

The above mentioned DDS module also generates the LF sine wave or square wave signal. This signal can be used as a source for internal modulation or as output signal at LFOUT BNC connector for frequencies up to 1 MHz in sine wave mode or up to 20 kHz in square wave mode. The output amplitude of the LF signal is set with a multiplying DAC in the range from 1 mV to 3 V.

Pulse Generator and Pulse Modulator

The pulse generator is also digitally implemented in the DDS module (FPGA). The pulse generator has three different modes. The pulse generator can run free, can be triggered or gated externally using the PULSE EXT input. The input impedance at the PULSE EXT BNC connector can be chosen high-impedance or 50 Ω . The pulse signal serves as a source for internal pulse modulation and can additionally be applied at the output PULSE/VIDEO in a buffered way.

Below 23.4375 MHz the pulse modulator is implemented digitally switching on and of the output signal of the DAC. Above 23.4375 MHz three RF switches in series are used as pulse modulator.

Modulation matrix and AM/FM/φM modulator

The external modulation signal from MODEXT can be AC- or DC-coupled. This signal is converted into the digital domain by the means of a 12 Bit ADC. The Frequency and Phase Modulations are implemented fully digital in the DDS module. For output frequencies below 23.4375 MHz the AM is implemented fully digital as well. For RF frequencies above 23.4375 MHz, the modulation signal is applied as reference signal to the level control loop. The AM modulation depth is set by a multiplying DAC. A switch matrix to select internal, external or internal + external modulation signals is implemented in analog circuitry and additionally in the digital domain. For RF frequencies from 23.4375 MHz to 375 MHz a variable gain differential amplifier and above 375 MHz a PIN modulator is used as AM modulator in the RF path.

Automatic Level control

With the means of a directional coupler a small part of the output of the power amplifier is fed to an RF detector. The output signal of this RF detector is fed to the Automatic Level Control (ALC) unit. The ALC sets the Level Control Voltage controlling the AM modulators to reach the desired output level.

Step Attenuator and reverse power protection

Due to the limited dynamic range of the ALC RF detector the regulated RF signal is attenuated with passive attenuators. The step attenuator is a settable attenuator with known attenuation.

At the RF output of the RF Board a reverse power protection circuitry detects RF power fed into the RF Board from outside the instrument. To protect the R&S SMBV against damage a relay disconnects the RF output, when a reverse power of more than approximately 34 dBm is detected. In standby or power off mode this relay is also in off state to protect the RF output of the instrument from damage.

Supply voltage control and filtering

The module supply voltages are filtered by means of passive filtering and additional active voltage regulators. Linear regulators with very good noise and distortion suppression characteristics have been implemented based on operational amplifier circuitry.

Power Supply Module

The power supply module provides all necessary voltages for the operation of the signal generator. It can be switched on and off by means of the power switch on the rear panel. After switch-on, the instrument is either in standby or in operating mode, depending on a value stored in an internal EEPROM.

The power supply works over a wide input voltage range from 100 V to 240 V ($\pm 10\%$) and AC supply frequencies from 50 Hz to 60 Hz ($\pm 5\%$).

On the secondary side, the power supply generates three DC voltages (+5.0 V, +13.25 V, -13.25 V) and one standby voltage (+5 V), all $\pm 5\%$.

The secondary voltages are open-circuit-proof and short-circuit-proof with respect to ground and each other.

The power inlet module contains two fuses. Replace these fuses only with type and rating specified on the rear panel. If the replaced fuse blows again, change the module.

Further fuses are fitted on the Basis Board as a means of fire protection.

Basis Board 2 and 4

Basis Board 2:

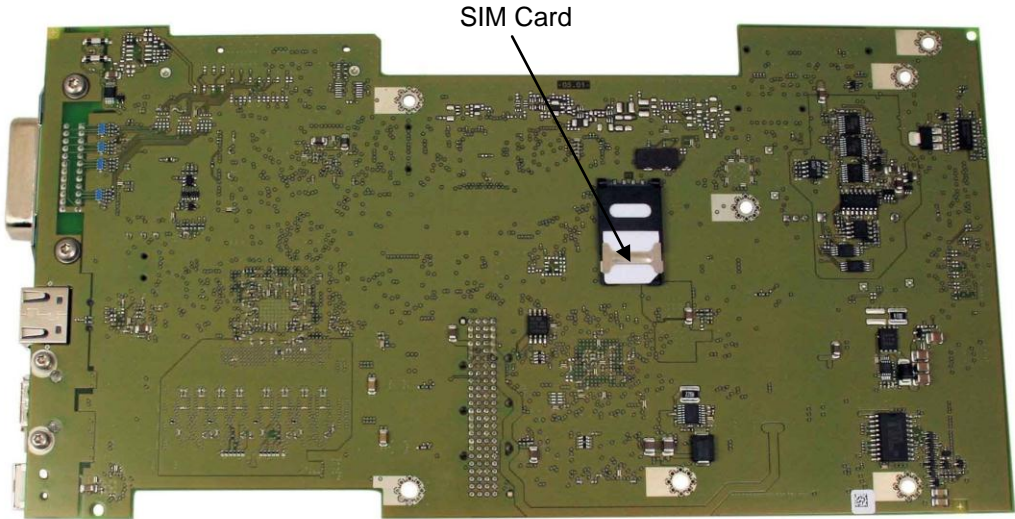
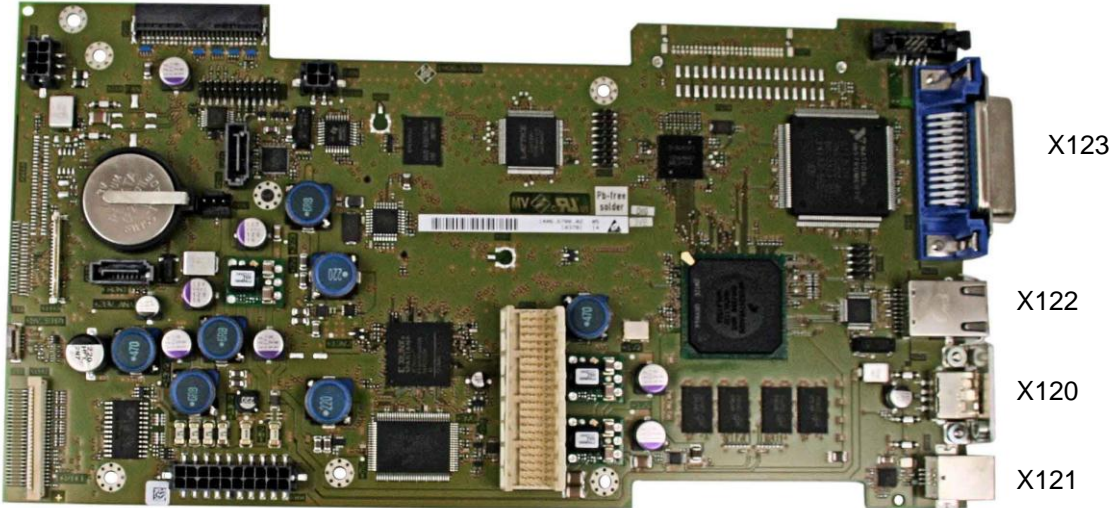

Basis Board 4: (installed in SMBV100A with serial numbers $\geq 260\ 001$)

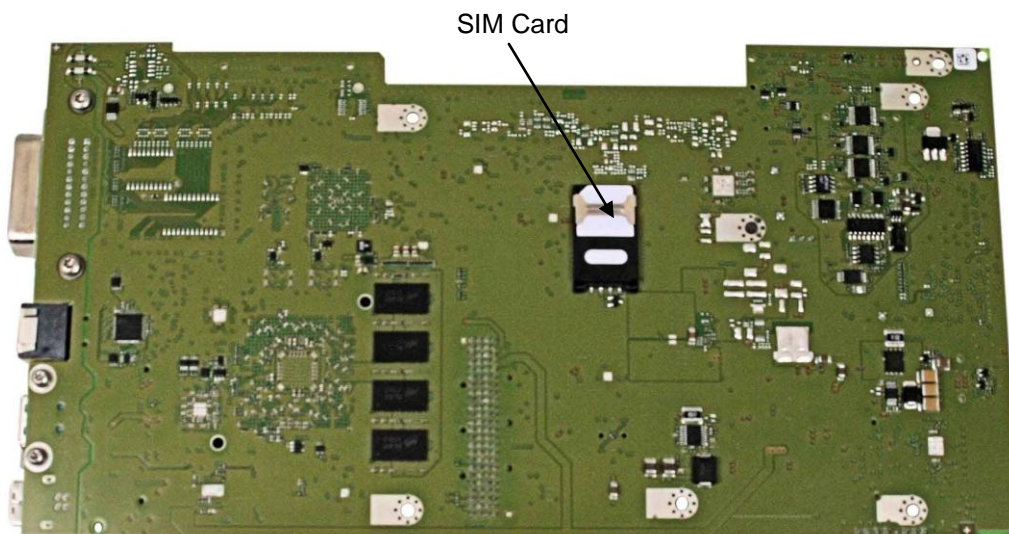
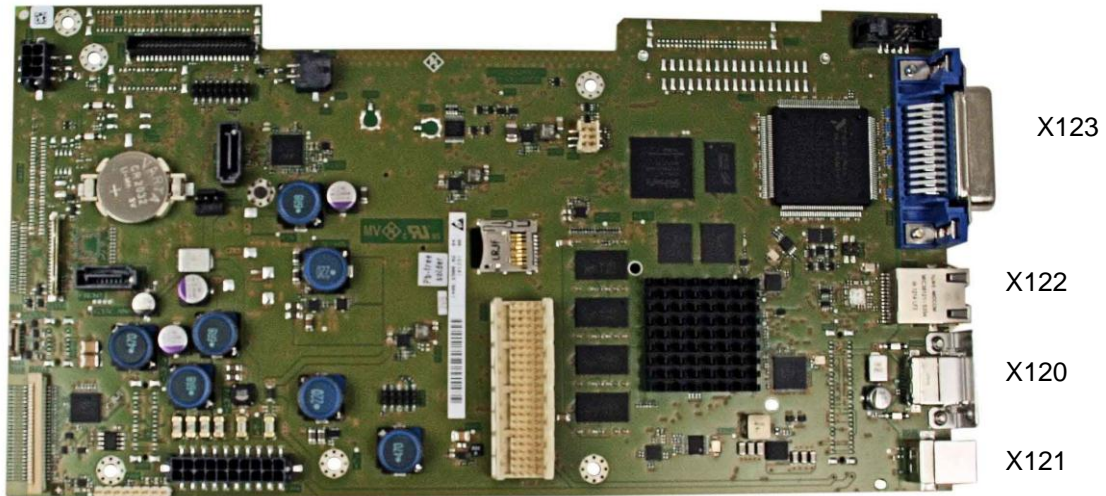

The Basis Board of the signal generator involves the following components and modules:

Fuses

Each supply voltage is fused with one or several fuses on the Basis Board.

Switching regulators

The built-in switching regulators generate the additional 1.2 V, 1.8 V, 3.3 V, 7 V and 28 V supply voltages.

Controller

Central Controller of the R&S SMBV including all memory devices and external interfaces.

FPGA (SMB_COM)

The SMB_COM FPGA contains the serial bus for internal communication of the instrument, timer functions and the display controller.

SIM Card

The instrument identity (Serial Number and Options) is stored on a SIM card. The SIM card is mounted on the backside of the Basis Board.

Keyboard Controller

The keyboard controller notifies the processor about keyboard and spin wheel events. The keyboard controller switches on or off the power supply module and memorizes the power on state of the instrument when the main power is cut. This state is reconstituted on powering the instrument again.

Diagnostic ADC

The diagnostic ADC is used for measuring the voltages in the unit. These voltages are used for internal adjustments and the ALC S&H mode of the R&S SMBV. Additionally the failure diagnostic of the instrument is carried out by the use of ADC.

EEPROM

The following data is stored here: Serial number of the instrument, header line data of the board.

Temperature sensor

A temperature sensor mounted on the Basis Board monitors the temperature. If a defined temperature above the guaranteed maximum operating temperature is exceeded, the power supply is switched off. So the R&S SMBV secures itself against damage due to overheating.

Fan Controller

A fan for cooling the RF modules is connected to the Basis Board and directly controlled according to the temperature of the Basis Board. This is done independent of the controller.

Vector Board

The Vector Board provides all the functionality to enable I/Q modulation of the RF carrier.

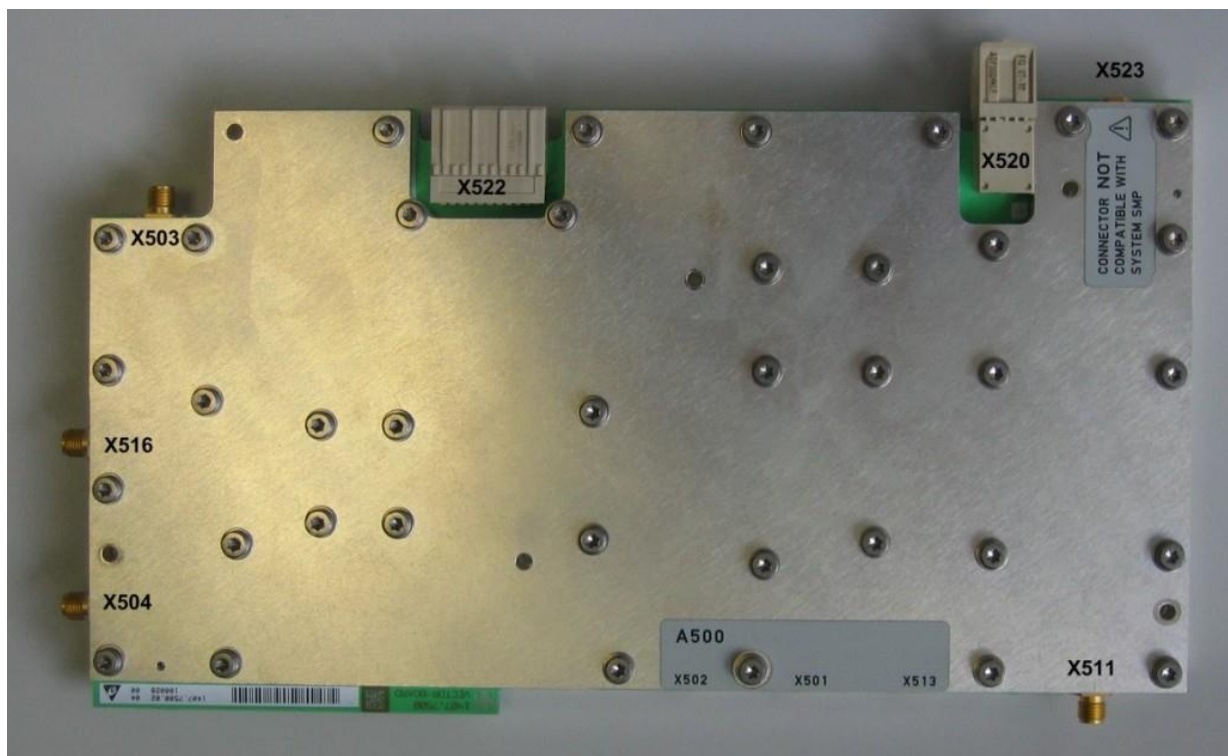

It comprises the following function blocks:

- control logic and FlashPROM for identification and correction data
- LO switch matrix for external LO coupling (external input and output)
- baseband section with imbalance and offset impairment circuitry
- R&S I/Q modulator ASIC
- I/Q quadrature control loop
- RF path (amplifiers and level control circuits)
- down converter
- 1200 MHz clock generation (mixer LO and BBGEN Board clock)
- level control circuit

Control Logic and Flash PROM

All digital controls are actuated via a digital serial bus. This serial signal is decoded on the Vector Board. A Flash PROM is connected to the serial bus, holding an identification header as well as correction data used by the R&S SMBV firmware.

Supply voltage regulators

All Vector Board supply voltages are stabilized via onboard active regulators out of the -12V, -7V, +5V, +7V, +12V and +28V lines that are supplied by the Basis Board. The output of every active regulator is connected to a test point that can be read out using the R&S SMBV Firmware (manually or via selftest sequence).

LO switch

During normal operation the local oscillator signal for the I/Q modulator IC is supplied by the RF Board connected to X516 on the Vector Board (0 dBm to +10 dBm).

However, if the Phase Coherence option R&S SMBV-B90 is fitted, an external LO signal can be used as well. This signal is connected to the backplane of the instrument, from where a semi rigid coax cable is routed to X503 on the Vector Board. (+10 dBm recommended)

With option R&S SMBV-B90, the internal or external LO signal is amplified and limited to 10 dBm +/- 4 dB. It is available at X504 of the Vector Board, from where a semi rigid coax cable is routed to the backplane of the instrument. The output signal can be switched on or off via software.

Baseband

The baseband section comprises the following functions:

- external single ended I and Q inputs
- internal differential I and Q inputs
- DC calibration signal for external path
- internal / external switching
- I/Q normal and I/Q swap switching
- I/Q gain imbalance
- I/Q DC offset

The external I/Q signals are connected to X501 and X502 on the Vector Board via SMP cables from the front plane.

The differential internal I and Q signals from the BBGEN Board are routed via X520 on the Vector Board.

I/Q modulator ASIC

The I/Q modulator is an application specific integrated circuit with the following functions:

- LO buffer amplifiers
- I/Q quadrature circuitry
- high linearity I/Q mixers

It is a direct modulator in the frequency range 200 MHz to 6 GHz. Below 200 MHz, the modulated signal is generated 1200 MHz above the RF frequency and then mixed down with the down converter.

RF path

The RF path consists of a number of high linearity broadband amplifiers and electronic level control attenuators.

The frequency range of the RF path is 150 MHz to 6.5 GHz. Baseband signals which might feed through the I/Q-modulator below 100 MHz are suppressed by a high pass circuit in the RF path.

Down converter

RF frequencies between 100 kHz and 200 MHz are modulated with a LO frequency of 1.2 to 1.4 GHz. This signal is then amplified and level controlled. A high linearity mixer with a mixer LO frequency of 1.2 GHz converts it down to the desired RF frequency. The down converted signal is amplified with a high linearity IF amplifier.

1200 MHz LO and clock generation

The local oscillator signal for the down converter mixer as well as the system clock of the BBGEN Board are both generated on the Vector Board.

Therefore, a 1.2 GHz low phase noise VCO is phase locked to the 200 MHz reference signal of the RF Board. The 200 MHz signal is connected to X513 of the Vector Board with a power level of +4 dBm typical.

If the 200 MHz reference is missing, the LO/clock signal will still be available to the mixer and the BBGEN, but the frequency will be out of specification (1.1 GHz approximately) and the "PLL unlocked" interrupt will be raised.

The clock signal for the BBGEN is available at X523 on the Vector Board with a power level of 0 dBm typical. However, if the BBGEN is not detected, this output will be switched off by the R&S SMBV firmware. In this case, the power level at X523 is -40 dBm approximately.

Attention:

X523 is a so-called "SMP long wipe" connector that is not compatible with the SMP system. An adapter from the proprietary system to standard SMA is available at

*Rosenberger Hochfrequenztechnik GmbH & Co. KG
84526 Tittmoning
Germany
<http://www.rosenberger.de>
Part number: 17K132-K00S3*

Level control circuit

The level control circuit receives the analog level control signal from the RF Board. It is superimposed to the 200 MHz reference signal and connected to X513 of the Vector Board.

This external level control signal will be used for setting the RF level in the "ALC on" mode and during the sample phase of the "Sample & Hold" mode.

An internal DAC signal will be used for setting the RF level in the "table" mode and during the hold phase of the "Sample & Hold" mode.

BBGEN Board

The BBGen Board is a retrofittable digital signal processing board that allows the generation of complex modulation signals and communication standards.

It is available in two versions:

ARB-BBGEN Board (.03):

In this version, the BBGEN Board operates as a arbitrary waveform generator (ARB). Pre-calculated I/Q sequences can be uploaded, stored and played back.

RT-BBGEN Board (.02):

In addition to its ARB functionality, this version is capable of real-time generation of I/Q signals. Various advanced communication standards are available for purchase.

The generated or played back I/Q data is available as a digital data stream, on the external analog I/Q output and as an internal modulation signal for the Vector Board with its I/Q modulator.

The BBGEN Board module provides the following functions

- Storing data lists and I/Q waveforms in an internal SDRAM-Module
- Encoding and modulation of stored or generated data at the desired symbol rate
- Filtering of the modulation symbols (e.g. root cosine)
- Conversion of the clock rate at the symbol level to the clock rate of the converter
- Adding ARB signals to the symbol level or to the output signal
- Level adjustment of the generated signal in the baseband.
- Conversion of an digital I/Q signal to an analog I/Q signal
- Adjusting the Level of the I/Q signals at the BNC-Outputs
- Bi-direction interface for digital IQ signals
- Generation of time marker signals
- Start/stop and clock synchronization of two R&S SMBV BBGEN Boards

LI Bridge

The LI Bridge is an electrical riser board connecting the Basis Board with the Vector Board and the BBGEN Board. It does not hold any active components nor any soldered parts. The connectors are mounted using pressfit technology.

The LI Bridge carries the following signals:

- analog power supply lines (to Vector Board)
- digital power supply lines (to BBGEN)
- a digital serial bus (to Vector Board and BBGEN)
- a digital high speed parallel bus (to BBGEN)
- dedicated digital control lines
- an analog measurement / diagnosis line (to Vector Board and BBGEN)

The internal I/Q signal path between the BBGEN and Vector Board is not routed via the LI Bridge but via a direct connection (X520 on the Vector Board) instead.

Troubleshooting

The purpose of these troubleshooting instructions is to help to trace down malfunctions to board level. The instrument can thus be made ready for use again by means of board replacement.

If error tracing doesn't show clear results, we recommend that you ship your instrument to our experts in the service centers (see address list) for module replacement and further error elimination. Some module replacements involve calibration procedures requiring calibrated equipment and appropriate software.

DANGER



Danger of shock hazard!

For module replacement, ensure that the instrument is switched off and disconnected from the power supply by removing the plug from the AC and DC power connector.

Read all safety instructions at the beginning of this manual carefully before module replacement!

NOTICE

Risk of damage to the boards!

Be careful not to cause short circuits when measuring voltages at pins placed close together!

The following utilities are provided in the signal generator for easy diagnosis:

- Internal selftest
- Internal diagnosis test points
- Internal adjustments
- Info line with error messages and history of messages
- Internal keyboard test

Note: When problems occur, first check whether any connections (cables, plug-in connections of boards, etc) are damaged or wrongly connected.

Measuring Equipment and Accessories

Item	Type of equipment	Specifications recommended	Equipment recommended	R&S order No.
1	DC voltmeter		R&S URE	0350.5315.02
2	Spectrum analyzer	Frequency range 0 to 7 GHz	R&S FSP	1164.4391.07
3	Adapting cable	50 cm to 1 m long RF cable SMP right angle female-to-SMA or N male connection	-	
4	Oscilloscope	Bandwidth \geq 50 MHz	Hameg HM504-2	
5	Adapting Cable	50 cm to 1 m long RF cable SMA right angle male - to-SMA or N male connection		
6	DC power supply	DC: voltage = 0-5 V current < 0.5 A		

Switch-On Problems

When the instrument is switched on, the following modules are involved:

- Power supply
- Basis Board
- Switching pad

To analyze switch-on and switch-off problems that occur with the R&S SMBV, the interplay of the individual modules is summarized in the following.

The R&S SMBV has an automatic restore from power loss. If the device was switched on before loss of AC power, it automatically turns on when AC power comes back. If it was in Standby when AC power was lost, then it automatically goes to Standby again after AC power recovers.

Switch-on

Basis Board 2

When the ON/OFF button on the front panel is pressed, the voltage of the ON/OFF test point at X1112 (switching pad connector) goes low. In this case the Basis Board 2 pulls the signal on pin 13 of X101 (power supply connector see [Fig. 3-10](#)) low, which in turn switches on the power supply. In case of a prior emergency shutdown (pressing the ON/OFF Button for more than 5 seconds) it may take a few seconds until this mechanism works again.

Within four seconds after switch-on, the CPU takes over the control of pin 13 of the power supply connector. If the green LED on the front panel lights up for only a short time (approx. five seconds) and then the orange standby LED lights up again, this means that the CPU is not booting properly. The cause may be a defective or overheated power supply or Basis Board 2.

Basis Board 4

The switch-on behavior is completely controlled by the keyboard controller on the Basis Board. It gives some indication of its working by LED1 to LED3, see [Fig. 3-2](#).

- LED1: Shows whether the keyboard controller requests the AC power supply to turn on.
- LED2: Shows keyboard- and wheel events by flipping state.
Also turns on a few seconds after AC power on into standby state.
- LED3: Indicates the detected type of wheel. On: magnetic Encoder; Off: mechanical Encoder.

- **Error: Instrument cannot be switched on.**

Action	Possible error causes and further steps
Check power-on switch on the rear. Check fuses on the rear. ↓	Power switch OFF: Switch on power supply.
Check yellow LED (standby). ↓	LED remains unlit: Measure standby voltage at pin1 X101 (see Fig. 3-1). Rated value: 4.75 V... 5.25 V No voltage: Check power cable from power supply. no/faulty voltage: change power supply Otherwise: Loose Flex Switchboard (in X1112) or bad contacts.



Fig. 3-1 LED, X101 and ON/OFF Test point location at X1112 Basis Board 2

Switch-off

Besides pressing the power switch, the instrument can be switched off in three ways.

After briefly pressing the ON/OFF button on the front panel, the CPU performs a normal system shutdown and then powers off the power supply via pin 13 of the power supply connector.

Pressing and holding the button on the front panel for longer than five seconds leads to an emergency shutdown, which is controlled by special hardware on the Basis Board 2 or the keyboard controller on the Basis Board 4. In this case, no user data can be saved.

The instrument can also be switched off by means of the temperature monitoring circuit on the Basis Board 2. If the temperature sensor on the Basis Board 2 detects an over temperature (e.g. in the event that a fan fails), the power supply is switched off via pin 13 of the power supply connector. It can only be switched on again, after cooling down.

- **Error: Signal generator starts up but display remains black**

Description of error	Possible error causes and further steps
CPU does not boot correctly	<ul style="list-style-type: none"> ➤ Check red LED on Basis Board 2 (see Fig. 3-1), or green LED 4 on Basis Board 4, see Fig. 3-2. <p>If LED does not turn on approx. 1 sec after power on, either the Basis Board FPGA does not configure correctly or the CPU does not boot: try to update the firmware, which includes the FPGA configuration data.</p> <p>If this does not help: Change Basis Board</p>
Cables are loose	<ul style="list-style-type: none"> ➤ Check cabling between Basis Board and Display
TFT display defective	<ul style="list-style-type: none"> ➤ Replace Front panel with TFT display

- Error: Fan does not work

Description of error	Possible error causes and further steps
Fan does not work	<p>Disconnect fan and check voltage on Basis Board X1116 (fan connector) between pin 1 and 2 (see Fig. 3-3 or Fig. 3-4).</p> <p>Rated voltage: 8 V ... 13 V, depending on temperature.</p> <p>Correct voltage: Replace fan</p> <p>Faulty voltage: Check the power supply of the Basis Board (see page 3.35).</p>

Basis Board 4:

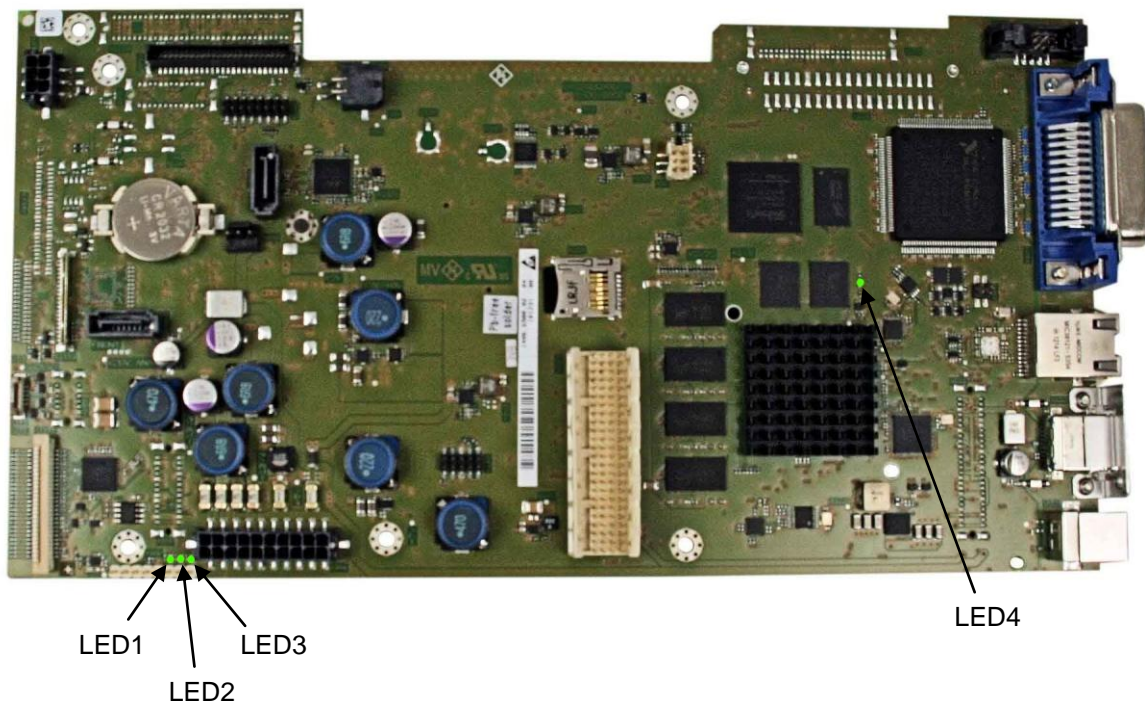

Fig. 3-2 LED Indication

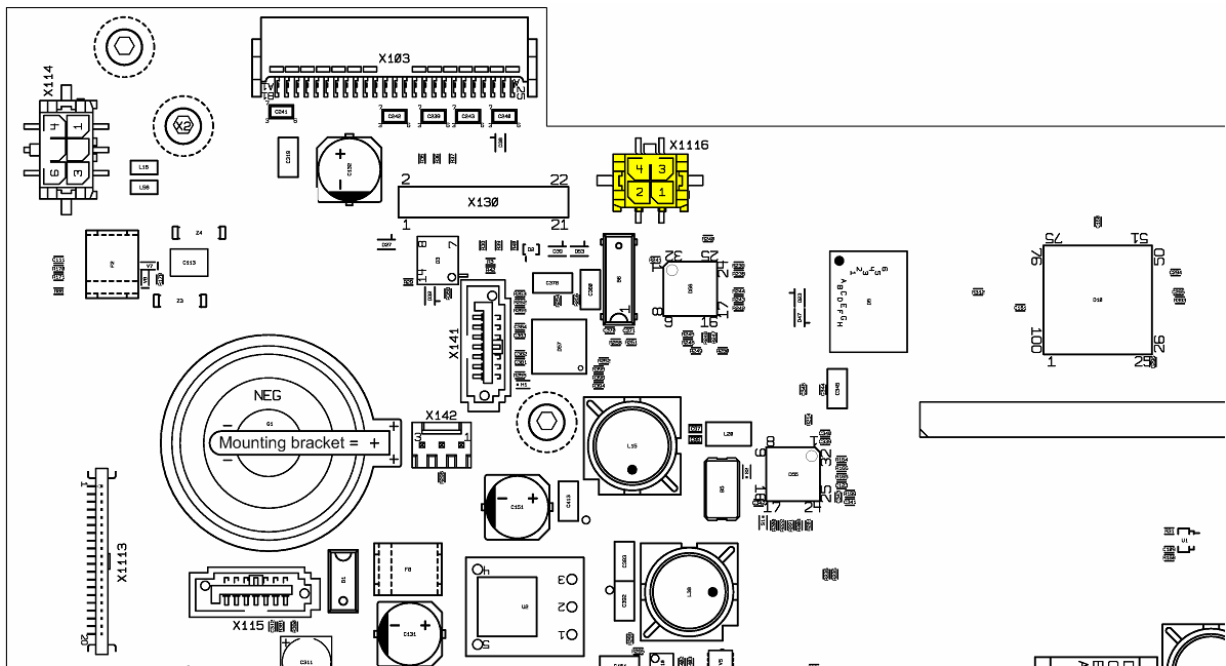

Fig. 3-3 X1116 Fan Connector Pin Location on Basis Board 2

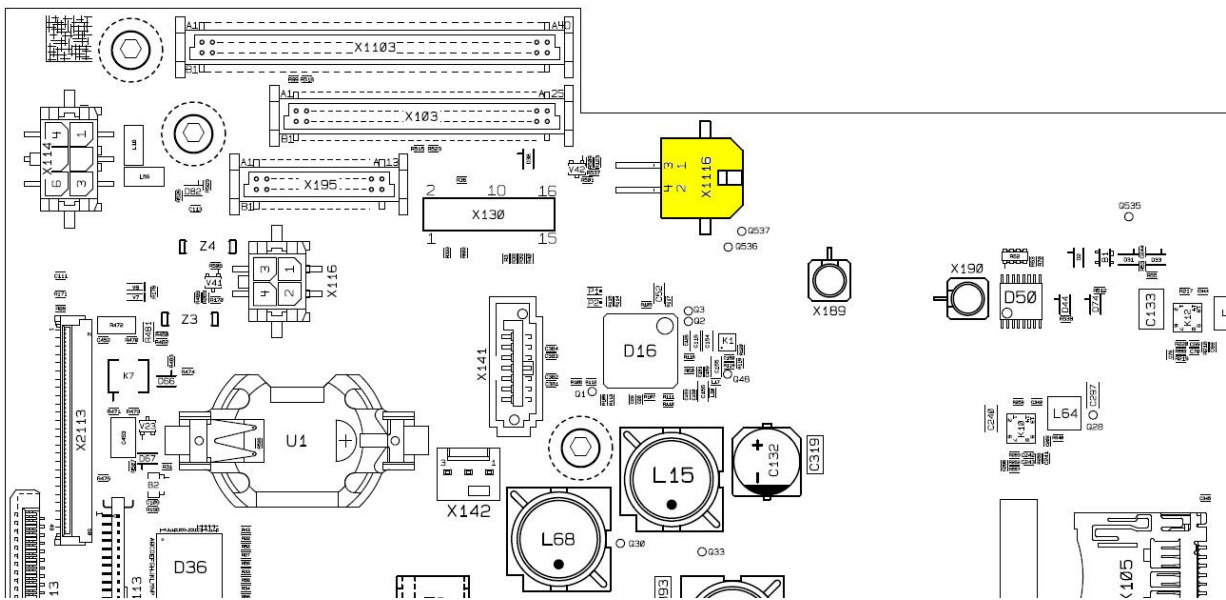



Fig. 3-4 X1116 Fan Connector Pin Location on Basis Board 4

Problems with Booting

- **Error: Unit does not start the application**

After switch-on, the signal generator first runs the Boot Loader. The Boot Loader displays the R&S Logo. The Boot Loader loads the FPGAs on the Basis Board and on the RF Board. After successful initialization of the computer (approx. 10 seconds), the LINUX operating system starts up and displays the background picture. Subsequently, the application is loaded. During loading, several progress bars are shown on the display.

All software of the R&S SMBV is stored in an on board flash memory. There are no serviceable hardware parts related to mass memory. The only possible service action is the reinstallation of firmware, which requires at least some basically working computer and firmware.

Normal action	Error, possible causes and corrective action
<p>➤ Start signal generator</p>	 <p>R&S logo does not disappear</p> <p>Error: The operating system (LINUX) does not start.</p> <p>Try to reinstall the firmware with the help of the maintenance system (see chapter 4). If this is not possible or does not solve the problem, replace the Basis Board.</p>

Keyboard and Rotary Knob Test

- This utility allows you to check for proper operation of all front panel control elements

Normal action	Error, possible causes and corrective action
Test called with SETUP - Check Front Panel...	
An image of the front panel appears with gray keys. When a key is pressed once or the knob is moved, the field changes to green. If the key is pressed more than once, the field changes to red.	Note: <i>Be careful with the rotary knob! Turn only one step in the specified direction; otherwise the field will change to red.</i>
When all operating elements including the rotary knob have been actuated once, all fields are green. If operating elements have been actuated twice, the fields are red.	If the color changes to red at the first actuation, a malfunction has occurred (bouncing). If the color of the corresponding field remains the same after actuation, the function is defective. In either case: Change the switching pad and/or rotary knob.
A message is output when all keys have been pressed: "All Front Panel Keys were accessed correctly"	Note: <i>No error message is output even if a number of keys are red. The user must decide whether a malfunction has occurred.</i>

USB Cable Test

USB cables of good quality are required for EMI suppression and stable connections.

However, according to our experience USB cables are of varying and often poor quality. This concerns the connection between the cable shield and the shield contacts of the connectors.

Cables of poor quality may cause EMI interference and poor connection quality. EMI interference, among other things, may ultimately lead to measurement errors. Poor connection quality may create problems like increased latencies that are due to retransmissions because of data corruption or may even lead to a complete loss of data connection.

Therefore, we recommend checking every USB cable using the following easy method:

Measure the electrical resistance from the shield contact of one connector to the shield contact of the other connector. For correct measurement results, consider the contact resistance at your probe tips. Good cables have a value of less than 0.6 Ω according to USB standards.

Also check, whether the resistance is stable when you bend the cable.

Troubleshooting using Internal Selftest

The internal selftest checks the instrument by measuring internal diagnostic points. **In case of an instrument fail this check should always be done first.**

Execute **SETUP** ⇒ **Selftest** ⇒ Selftest. The selftest reports the modules failing the test:



To see the details of the selftest select the board failing the selftest:

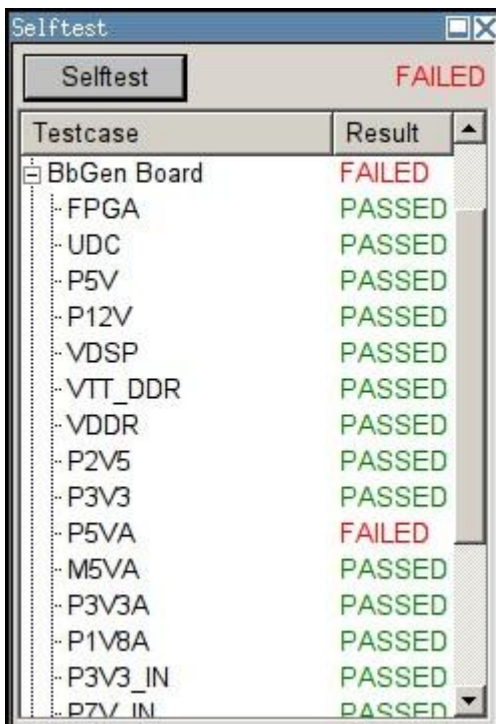

If the Basis Board fails this test check the fuses and supply voltages from the power supply (see page 3.35). When the Basis Board fails this test the other modules cannot work correct. So only if the Basis Board passes the selftest, check the other modules failing the selftest.

Troubleshooting using Internal Test Points

A diagnostic A/D converter on the Basis Board allows you to measure voltages at internal test points, which are located on all important modules of the instrument.

Diagnostic test points are located on following modules:

- Basis Board
- RF Board
- Vector Board
- BBGEN

The internal selftest checks all voltages at the points listed below, so if the selftest passes without a fail skip this manual test.

Normal action	Error, possible causes and corrective action
<p>Internal diagnosis switched on with: SETUP - Test Points...</p> <p>Select the desired test point under Select Test Point.</p> <p>To operate, set State ON</p>	
<p>The measured voltage is displayed under Voltage.</p> <p>"99.9999V" means that the test point does not exist.</p> <p>The diagnostic system operates with multiplexers on each board to switch the desired test point to the appropriate DIAG line on the Basis Board. Each test point is switched to the line only for the time of a measurement and switched off after it. The A/D converter is located on the Basis Board.</p> <p>It is advisable to begin by checking the test points on the Basis Board, since the diagnostic converter is located on this module.</p>	<ul style="list-style-type: none"> ➤ For troubleshooting refer to the following chapters. ➤ Compare the displayed values with the values specified in the next table. <p>Major deviations from the named values indicate a defect: Change the affected module.</p> <p>If all test points are out of tolerance, maybe only one of the modules is defective and disturbs the diagnostic system. To determine which module is defective, remove all modules that include test points one after another, except the Basis Board. If values are still out of tolerance, replace the Basis Board.</p> <p>If the remaining test points are in tolerance after removing a module the module removed is defective. Replace this board.</p>

Module	Test Point	Min	Max	Function
Basis Board	DIAG_SMB_BAB_ADCGRD	-25 mV	25 mV	Reference Ground
	DIAG_SMB_BAB_P7V	6.4 V	7.6 V	Supply Voltages
	DIAG_SMB_BAB_P5V	4.6 V	5.4 V	
	DIAG_SMB_BAB_P3V3	3.1 V	3.5 V	
	DIAG_SMB_BAB_P12V	12.2 V	14.3 V	
	DIAG_SMB_BAB_P0V9	0.88 V	0.92 V	
	DIAG_SMB_BAB_P28V	25.8 V	30.2 V	
	DIAG_SMB_BAB_P2V5	2.3 V	2.7 V	
	DIAG_SMB_BAB_P1V2	1.1 V	1.3 V	
	DIAG_SMB_BAB_M12V	-14.3 V	-12.2 V	
	DIAG_SMB_BAB_M7V	-7.6	-6.4	Temperature in deg C
	DIAG_SMB_BAB_TEMP	0	75°	
RF Board	DIAG_SMB_RF_VDET	-25 mV	9.5 V	ALC control voltages
	DIAG_SMB_RF_LCON	-1 V	8 V	
	DIAG_SMB_RF_LCON	-1 V	8 V	
	DIAG_SMB_RF_DET_I	-25 mV	2 V	
	DIAG_SMB_RF_DET_I	-25 mV	2 V	Extern Modulation Input
	DIAG_SMB_RF_MODEXT	-1.2 V	1.2 V	
	DIAG_SMB_RF_TCXOCTRL	-25 mV	5 V	Synthesizer control voltages
	DIAG_SMB_RF_MAINPLL	-2 V	7 V	
	DIAG_SMB_RF_2LOOPF	-2 V	7 V	
	DIAG_SMB_RF_X7000	-25 mV	22 V	
	DIAG_SMB_RF_X7000	-25 mV	25 mV	
	DIAG_SMB_RF_3V3_SWI	2.3 V	3.7 V	Supply Voltage
	DIAG_SMB_RF_TEMP_PA	0	80°	Temperature in deg Celsius
	DIAG_SMB_RF_TEMP_NFAMP	0	80°	
	Vector Board	DIAG_VECBRD_M11VB1	-11.2 V	-10.8 V
DIAG_VECBRD_M6VB1		-5.5 V	-5.3 V	
DIAG_VECBRD_M6VB2		-5.5 V	-5.3 V	
DIAG_VECBRD_4VB1		+3.8 V	+4.2 V	
DIAG_VECBRD_5VB1_REF		+4.8 V	+5.2 V	
DIAG_VECBRD_6VB1		+5.5 V	+5.9 V	
DIAG_VECBRD_6VB2		+5.5 V	+5.9 V	
DIAG_VECBRD_6VB3		+5.5 V	+5.9 V	
DIAG_VECBRD_6VB4		+5.5 V	+5.9 V	
DIAG_VECBRD_6VB5		+5.5 V	+5.9 V	
DIAG_VECBRD_11VB1		+10.8 V	+11.2 V	
DIAG_VECBRD_26VB1		+24.0 V	+28.0 V	

Module	Test Point	Min	Max	Function
BBGEN	DIAG_SMB_BBGEN_1V2_FPGA	1.176 V	1.224 V	Supply voltages
	DIAG_SMB_BBGEN_1V2_UDC	1.176 V	1.224 V	
	DIAG_SMB_BBGEN_P5V	4.735 V	5.047 V	
	DIAG_SMB_BBGEN_P12V	12.54 V	13.86 V	
	DIAG_SMB_BBGEN_VDSP	1.078 V	1.122 V	
	DIAG_SMB_BBGEN_VTT_DDR	0.882 V	0.918 V	
	DIAG_SMB_BBGEN_VDDR	1.764 V	1.836 V	
	DIAG_SMB_BBGEN_P2V5	2.450 V	2.550 V	
	DIAG_SMB_BBGEN_P3V3	3.201 V	3.399 V	
	DIAG_SMB_BBGEN_P5VA	4.900 V	5.100 V	
	DIAG_SMB_BBGEN_M5VA	-5.150 V	-4.850 V	
	DIAG_SMB_BBGEN_P3V3A	3.201 V	3.399 V	
	DIAG_SMB_BBGEN_P1V8A	1.746 V	1.854 V	
	DIAG_SMB_BBGEN_P3V3_IN	3.201 V	3.399 V	
	DIAG_SMB_BBGEN_P7V_IN	6.650 V	7.350 V	
	DIAG_SMB_BBGEN_M7V_IN	-7.350 V	-6.650 V	
	DIAG_SMB_BBGEN_M12V	-13.86 V	-12.54 V	
	DIAG_SMB_BBGEN_M10VA	-10.30 V	-9.70 V	
	DIAG_SMB_BBGEN_P1V8D	1.746 V	1.854 V	
	DIAG_SMB_BBGEN_P3V3_HF	3.395 V	3.605 V	

Troubleshooting using Internal Adjustments

Various internal adjustments are necessary for correct operation of the instrument. The failure of a certain adjustment can shorten troubleshooting considerably. The affected modules are the Basis Board, the RF Board, the Vector Board and the BBGEN.

Note: Failed internal adjustments can also be queried on the info page -> History.

Normal action	Error, possible causes and corrective action
<p>Internal adjustments call: [SETUP] ⇒ Internal Adjustments ⇒ Adjust Synthesis Internal adjustment of the Synthesizer on the RF Board is executed.</p>	<p>Abort during adjustment: The adjustment is carried out exclusively on the RF Board, only the Diagnostic A/D converter on the Basis Board is needed. Run the internal selftest to check the Basis Board (see page 3.20). If the Basis Board passes this test most probably the RF Board is defective. Check the RF Board (see page 3.38). If not in tolerance check the Basis Board (see page 3.35).</p>
<p>Internal adjustments call: [SETUP] ⇒ Internal Adjustments ⇒ Adjust Level Internal adjustment of the level circuitry on the RF Board and the Vector Board is executed.</p>	<p>Abort during adjustment:</p> <ul style="list-style-type: none"> ➤ Level Calibration: this adjustment is carried out exclusively on the RF Board, only the Diagnostic A/D converter on the Basis Board is needed. Run the internal selftest to check the Basis Board (see page 3.20). If the Basis Board passes the selftest most probably the RF Board is defective. Check the RF Board (see page 3.38). ➤ Vector Level Calibration: This adjustment is carried out exclusively on the Vector Board, only the Diagnostic A/D converter on the Basis Board is needed. If it fails most probably the Vector Board is defective. Check the Vector Board (see page 3.44). ➤ Learning ALC Table (Vector): This adjustment is carried out on the RF Board and the Vector Board using the Diagnostic A/D converter on the Basis Board. If it fails most probably the Vector Board or the RF Board is defective. First check the signals between the RF Board and Vector Board. (see page 3.31) Then check the Vector Board (see page 3.44) and RF Board (see page 3.38).
<p>Internal adjustments call: [SETUP] ⇒ Internal Adjustments ⇒ Adjust IQ Modulator Full Range Internal adjustment of the I/Q-modulator impairments is executed.</p>	<p>Abort during adjustment: This adjustment is carried out on the RF Board and the Vector Board using the Diagnostic A/D converter on the Basis Board. If it fails run the internal selftest to check the Basis Board (see page 3.20). If the Basis Board passes the selftest most probably the Vector Board or the RF Board is defective. First check the signals between the RF Board and Vector Board. (see page 3.31) Then check the Vector Board (see page 3.44) and RF Board (see page 3.38).</p>

Instrument Faults

The following table lists R&S SMBV Faults. For every fault additional test are described to determine the defective module. **It is strongly recommended to run the internal selftest first (page 3.1). The following descriptions assume that the instrument passes the internal selftest!**

Fault	Test	Action if test fails
RF Output Level in CW-mode is wrong	R&S SMBV settings: <ul style="list-style-type: none"> • Instrument Preset • Reference internal • RF on • Level = 15 dBm Measure the Output Level with a power meter across the frequency range. The difference between set and measured level has to be lower than guaranteed in the datasheet.	Check the mating torque of the SMA-connector at cable W 212 being about 60 Ncm. Most probably the RF Board is defective. Check the RF Board (page 3.38).
RF Output Level in Analog I/Q-wideband-mode is wrong	Check output level in CW mode first (see above) If in tolerance set R&S SMBV to: <ul style="list-style-type: none"> • Instrument Preset • Reference internal • RF on • Level = 15 dBm • I/Q-Mod ⇒ Analog I/Q wideband in • I/Q-Mod: state on • Supply a DC-voltage of 0.5 V to the I-Input BNC-connector Measure the Output Level with a power meter across the frequency range. The difference between set and measured level has to be lower than guaranteed in the datasheet.	Most probably the Vector Board or the RF Board is defective. First check the signals between the RF Board and Vector Board. (see page 3.31) Then check the Vector Board (see page 3.44) and RF Board (see page 3.38).
RF Output Level in Internal Baseband- or ARB-mode is wrong	Check output level in CW mode and Analog wideband I/Q-mode first (see above). If in tolerance set R&S SMBV to: <ul style="list-style-type: none"> • Instrument Preset • Reference internal • RF on • Level = 15 dBm • Baseband ⇒ Multicarrier CW ⇒ No. of carriers: 1 • Baseband ⇒ Multicarrier CW ⇒ state: on 	
	Measure the output voltage at I-, IN, Q- and QN- output BNC connectors on the rear panel of the instrument with a high impedance DC voltmeter. The levels should be: I = 1.0 V, IN = -1 V, Q = 0 V, QN = 0 V	If voltages differ more than ± 0.05 V from these values check the BBGEN Board (see page 3.46).
	Measure the Output Level with a power meter at 1 GHz. The difference between set and measured level has to be lower than guaranteed in the datasheet.	Most probably the Vector Board is defective. Check the Vector Board (see page 3.44). If not in tolerance check the Basis Board (see page 3.35) If in tolerance check the Vector Board (see page 3.44).

Fault	Test	Action if test fails
RF Output Frequency is wrong	R&S SMBV settings: <ul style="list-style-type: none"> • Instrument Preset • Setup ➔ Adjustment ➔ 'Adjust all' • Setup ➔ Reference external • RF on • Level: 0 dBm Supply an external 10 MHz reference signal meeting the level and frequency specification given in the datasheet. Measure output frequency with a spectrum analyzer or a frequency counter synchronized to the same reference. The frequency error has to be < 0.1 Hz.	Most probably the RF Board is defective. Check the RF Board (see page 3.38).
	R&S SMBV setting: <ul style="list-style-type: none"> • Setup ➔ Reference internal Measure the 10 MHz reference output signal with spectrum analyzer or frequency counter and power meter. Output frequency and level have to meet the specifications given in the data sheet.	Without Reference Oscillator B1/B1H being equipped most probably the RF Board is defective. Check the RF Board (see page 3.38). If the R&S SMBV is equipped with Reference Oscillator R&S SMBV-B1/-B1H remove the unit (see page 3.102) and perform this test again. If it works most probably the Reference Oscillator B1/B1H is defective Check the Reference Oscillator (see page 3.44).
Poor Harmonic Distortion in CW mode	R&S SMBV settings: <ul style="list-style-type: none"> • Instrument Preset • Reference internal • RF on • ATT-Mode Auto • Level = Maximum guaranteed level for harmonic distortion (see datasheet) Measure the level of the fundamental frequency with a spectrum analyzer. The level of every harmonic has to be at least 30 dB lower than the level at the fundamental frequency. Repeat this test over the frequency range of the instrument. Comment: In ATT-Mode fixed harmonic distortion is not guaranteed above Levels displayed under 'Level' menu ➔ 'Attenuator Settings' ➔ 'Fixed Range in'.	Most probably the RF Board is defective. Check the RF Board (see page 3.38).
Poor Harmonic Distortion in I/Q mode	Check harmonic distortion in CW mode first (see above)	If only harmonic distortion in I/Q mode are out of tolerance check the harmonic distortion at the connecting RF cable between the RF Board and Vector Board (see page 3.31).

Fault	Test	Action if test fails
Overvoltage protection <i>does not trigger</i>	Switch on RF -> apply a RF power of >2 W to RF N connector -> The overvoltage protection must trigger.	If RF output is not switched of the RF Board is defective.
Slow Setting times	Setting times are defined for GPIB remote control only. The settling time is the time-delay after asserting EOI until level and frequency are within the given tolerance from their final values. Be careful not to measure with an instrument drifting on its own due to applying the RF from the R&S SMBV.	Most probably the RF Board is defective. Check the RF Board (see page 3.38).
10 MHz Reference Input faulty	Check the 10 MHz reference signal fed into the R&S SMBV with a spectrum analyzer or frequency counter and power meter. If level and frequency of this signal is matching the specification in the datasheet set the R&S SMBV to: <ul style="list-style-type: none"> • Instrument Preset • Reference external • RF on • Frequency = 1 GHz • Level = 0 dBm Check for error Messages. No "External Reference Errors" are allowed to occur. Measure output frequency with a spectrum analyzer or a frequency counter synchronized to the same reference. The frequency error has to be < 0.1 Hz.	Most probably the RF Board is defective. Check the RF Board (see page 3.38).
10 MHz Reference Output faulty	R&S SMBV setting: <ul style="list-style-type: none"> • Setup ➔ Reference internal Measure 10 MHz reference output signal with spectrum analyzer or frequency counter and power meter. Output frequency and level have to meet the specifications given in the data sheet.	<i>R&S SMBV without Reference Oscillator R&S SMBV-B1/-B1H:</i> Most probably the RF Board is defective. Check the RF Board (see page 3.38). <i>R&S SMBV with Reference Oscillator R&S SMBV-B1/-B1H:</i> Remove the Reference Oscillator B1/B1H (see page 3.102) and perform this test again. If still failing most probably the RF Board is defective. Check the RF Board (see page 3.38). If the 10 MHz reference signal is in tolerance most probably the Reference Oscillator B1/B1H is defective. Check this module (see page 3.44).

Fault	Test	Action if test fails
LFGen Output Faulty	R&S SMBV settings: • LFGen Stat off Measure the input resistance of the LF signal output with a multimeter. The input resistance should be $15 \Omega \pm 10 \Omega$.	Check the connection of cable W215 to the RF Board (see page 3.88). If it is connected correct most probably the RF Board is defective. Check the RF Board (see page 3.38).
	R&S SMBV settings: • Setup ➔ Reference internal • LFGen Stat on • LFGen Level 1 V • LFGen Frequency 100 kHz Attention: LF specification applies to loads greater or equal 200Ω only! Check the level at the 'LF'-BNC Connector with an oscilloscope or voltage meter. Check the frequency and harmonic distortion with an oscilloscope with FFT functionality or with a spectrum analyzer with high input impedance (i.e. with a 150Ω series resistor).	Most probably the RF Board is defective. Check the RF Board (see page 3.38).
MOD ext Input Faulty	Measure the input resistance of the Mod Ext BNC connector signal with a multimeter. The input resistance should be $221 \text{ k}\Omega \pm 20 \%$	Check the connection of cable W214 to the RF Board (see page 3.88). If connected correct most probably the RF Board is defective. Check the RF Board (see page 3.38).
Amplitude Modulation Faulty	The AM is specified only up to the Peak Envelope Power (PEP) noted in the datasheet. The PEP value of an AM signal with depth m at setting level P is $P_{PEP} = \text{Level} + 20 \log_{10}(1 + m/100)$ So at $m = 100 \%$ the PEP is 6.02 dB higher than the setting level shown in the display. The AM performance has to match the values given in the datasheet. Measure with a true demodulating receiver, i.e. a R&S FSMR or R&S FSL/ FSP/ FSU/ FSQ spectrum analyzer equipped with option R&S K7	Most probably the RF Board is defective. Check the RF Board (see page 3.38).
Frequency/ Phase Modulation Faulty	FM and PhiM Modulation are generated in the DDS synthesizer reference signal on the RF Board. Run Internal Adjustments to ensure the VCOs generating the RF signal working in their optimum. The FM performance has to match the values given in the datasheet. Measure with a true demodulating receiver, i.e. a R&S FSMR or R&S FSL/ FSP/ FSU/ FSQ spectrum analyzer equipped with option K7.	Most probably the RF Board is defective. Check the RF Board (see page 3.38).

Fault	Test	Action if test fails
Pulse Generator/ Pulse Modulator Faulty	The pulse generator is implemented fully digital in the RF Board FPGA. The pulse signals are fed exclusive on the RF Board to the pulse modulator switch. All external pulse-BNC connectors are fitted on the RF Board as well.	Most probably the RF Board is defective. Check the RF Board (see page 3.38).
Signal Valid	This signal is driven from the RF Board FPGA and the Signal Valid BNC connector is directly fitted onto the RF Board as well.	Most probably the RF Board is defective. Check the RF Board (see page 3.38).
Faulty Remote interface IEEE488, USB or LAN	All remote interfaces including the interface connectors are fitted directly on the Basis Board.	Most probably the Basis Board is defective. Check the Basis Board (see page 3.35).
I- or Q-Input faulty	<p>R&S SMBV setting:</p> <ul style="list-style-type: none"> • Instrument Preset • Reference internal • RF on • I/Q-Mod ⇒ Analog I/Q wideband in • I/Q-Mod: state on • Supply a DC-voltage of 0.5 V to the I-Input BNC-connector and 0 V to the Q-Input BNC-connector. <p>Check the diagnostic voltages: DIAG_VECBOARD_IX ⇒ 0.8 V ±0.2 V DIAG_VECBOARD_INX ⇒ -0.8 V ±0.2 V DIAG_VECBOARD_QX ⇒ 0 V ±0.1 V DIAG_VECBOARD_QNX ⇒ 0 V ±0.1 V</p> <p>Then swap the I- and Q-input voltages. The diagnostic voltages should swap correspondingly.</p>	<p>If the voltages are in tolerance check the signals between the RF Board and the Vector Board (see page 3.31).</p> <p>If the diagnostic voltages are out of tolerance measure the input resistance of the I-input and Q-input with a multimeter. The input resistance should be $50\Omega \pm 2\Omega$. If the input Resistance is very high or very low (short to GND) check the BNC to SMP I- and Q-input cables W501 and W502 by disconnecting them from the Vector Board. Check them with a multimeter for a short between inner and outer conductor and for an interruption of the inner conductor as well. If defective replace them. If they are OK, the Vector Board is defective and has to be replaced (see page 3.78).</p>

Fault	Test	Action if test fails
<p>Lo out faulty</p>	<p>The Lo out signal is available in I/Q-mode only. In CW-mode no output signal is available at Lo out! The Lo out signal is only available for frequencies above 200 MHz.</p> <p>First check if the R&S SMBV is working in I/Q-Mode by running Setup ⇒ internal adjustment ⇒ IQ-modulator ⇒ full range. If the internal adjustment finish successfully set the R&S SMBV to:</p> <ul style="list-style-type: none"> • Instrument Preset • Reference internal • RF on • I/Q-Mod ⇒ Analog I/Q wideband in • I/Q-Mod: state on • RF/A mod ⇒ Phase Coherence ⇒ Lo Out State on <p>The signal level at the Lo out connector should be 10dBm ±3 dB.</p>	<p>If no signal comes out the Lo out connector disconnect the cable W504 from the Vector Board and check it with a multimeter for a short between inner and outer conductor. Then check for an interruption of the inner conductor. If defective replace it. If the cable W504 is OK, the Vector Board is defective and has to be replaced (see page 3.78).</p>
<p>Lo in faulty</p>	<p>The Lo in-input is only functional in I/Q mode for frequencies above 200 MHz! In CW mode this input is not usable.</p> <p>First check if the R&S SMBV is working in I/Q-Mode by running Setup ⇒ internal adjustment ⇒ IQ-modulator ⇒ full range. If the internal adjustment finish successfully set the R&S SMBV to:</p> <ul style="list-style-type: none"> • Instrument Preset • Reference internal • RF on • I/Q-Mod ⇒ Analog I/Q wideband in • I/Q-Mod: state on <p>If the error message 'Lo power low' shows up on the info line check the signals between RF Board and Vector Board (see page 3.31). If not set:</p> <ul style="list-style-type: none"> • RF/A mod ⇒ Phase Coherence ⇒ Lo Mode external <p>Without supplying an external Lo-signal to the Lo in SMA-connector the error message 'Lo power low' has to show up on the info line (if not check the Vector Board, see page 3.31). Now supply an RF-signal of 1 GHz +10 dBm to the Lo in connector.</p>	<p>If the error message 'Lo power low' does not disappear disconnect the Lo in-cable W 503 from the Vector Board and check it with a multimeter for a short between inner and outer conductor. Then check for an interruption of the inner conductor. If defective replace it. If the cable W503 is OK, the Vector Board is defective and has to be replaced (see page 3.78).</p>

Checking signals between RF Board and Vector Board

The three RF cables W21, W216 and W211 connect the Vector Board with the RF Board. By checking the signals on them the defective module in mode I/Q-modulation can be localized. **It is strongly recommended to check these three cables for shorts and interruptions with a multimeter first.** Then check the signals in the following order:

200 MHz reference and level control signal from RF Board to Vector Board

The 200 MHz reference signal from the RF Board is always present as soon as the R&S SMBV has booted. The error message “mixer PLL unlocked” indicates that this signal is missing. To measure this signal set the R&S SMBV Reference Oscillator to internal, disconnect the SMP-cable W213 from X213 (RF Board) and measure the frequency and output level at X213 with a spectrum analyzer. **Caution: only use a spectrum analyzer with AC coupling or use a DC-block when measuring this signal!** The level should be 3 dBm \pm 2 dB and the output waveform is nearly rectangular. The spectrum should be similar to the measured R&S SMBV shown in [Fig. 3-5](#).

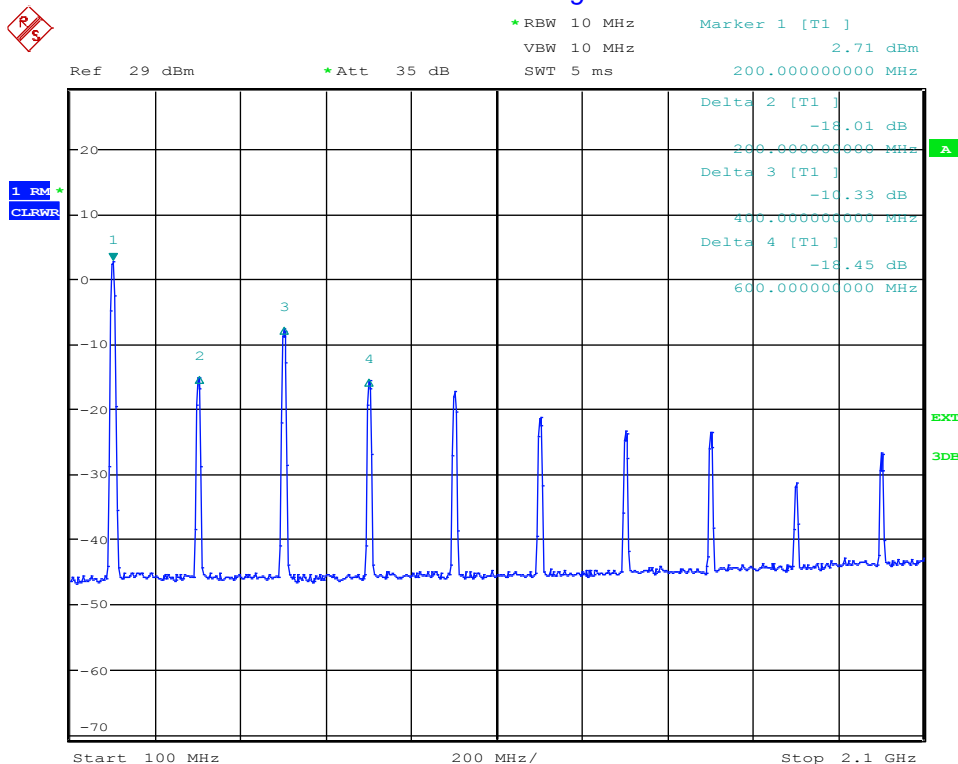

Date: 23.JUN.2008 14:58:25

Fig. 3-5 Measured 200 MHz reference-signal from a R&S SMBV

If the Reference signal is out of tolerance most probably the RF Board is defective. Check the supply voltages and the control signals of the RF Board (see page 3.38). If they are OK replace the RF Board (see page 3.88).

The level control signal from the RF Board to the Vector Board is superimposed to the 200 MHz reference signal on this cable. To check it set the R&S SMBV to:

- Instrument Preset
- Reference internal
- RF on
- I/Q-Mod ⇒ Analog I/Q wideband in
- I/Q-Mod: state on
- RF/A Mod ⇒ Automatic Level Control ⇒ ALC state on.

Disconnect W213 from X213 (RF Board) and measure the DC-Voltage. The ALC loop now is open and the level control voltage should go to its upper limit. Check the DC voltage to be 8 V – 10 V DC. If the voltage doesn't reach this range most probably the RF Board is defective. Check the supply voltages and the control signals of the RF Board (see page 3.38). If they are OK replace the RF Board (see page 3.88).

LO synthesizer signal from RF Board to Vector Board

The synthesized RF-signal at the output frequency is generated on the RF Board for the frequency range from 200 MHz to 6 GHz. In I/Q-mode the LO signal is fed to the Vector Board through W216. Below 200 MHz RF output frequency the I/Q-modulated signal is generated at 1200 MHz to 1400 MHz and then down converted to the output frequency by mixing it with a 1200 MHz signal. To check the LO signal from the RF Board set the R&S SMBV to:

- Instrument Preset
- Reference internal
- RF on
- I/Q-Mod ⇒ Analog I/Q wideband in
- I/Q-Mod: state on

Disconnect W216 from X216 on the RF Board and measure the output level at the frequencies the R&S SMBV is not working properly. The LO level should be within ± 3 dB of the measured LO level of a typical instrument shown in [Fig. 3-6](#).

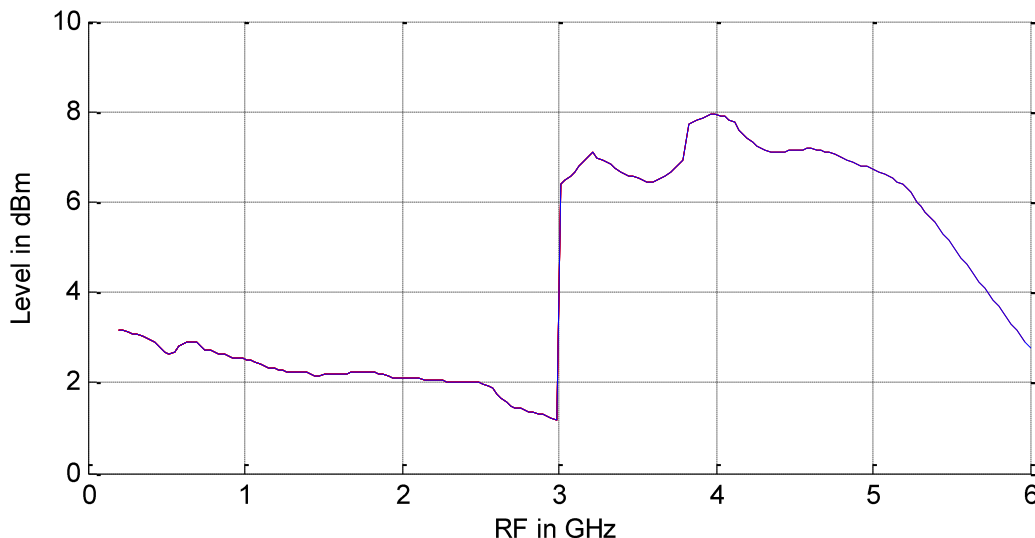

Fig. 3-6 Measured LO level in mode I/Q modulation at X216 of the RF Board

If the LO level is too low most probably the RF Board is defective. Check the supply voltages and the control signals of the RF Board (see page 3.38). If they are OK replace the RF Board (see page 3.88).

The harmonic distortion of the LO signal is not crucial for the proper work of the R&S SMBV. A harmonic level of -20 dBc for the second harmonic and -8 dB for the third harmonic is sufficient. In case of doubt measure the harmonics of the LO signal at X216 of the RF Board with the spectrum analyzer. The suppression of harmonics is shown in [Fig. 3-7](#).

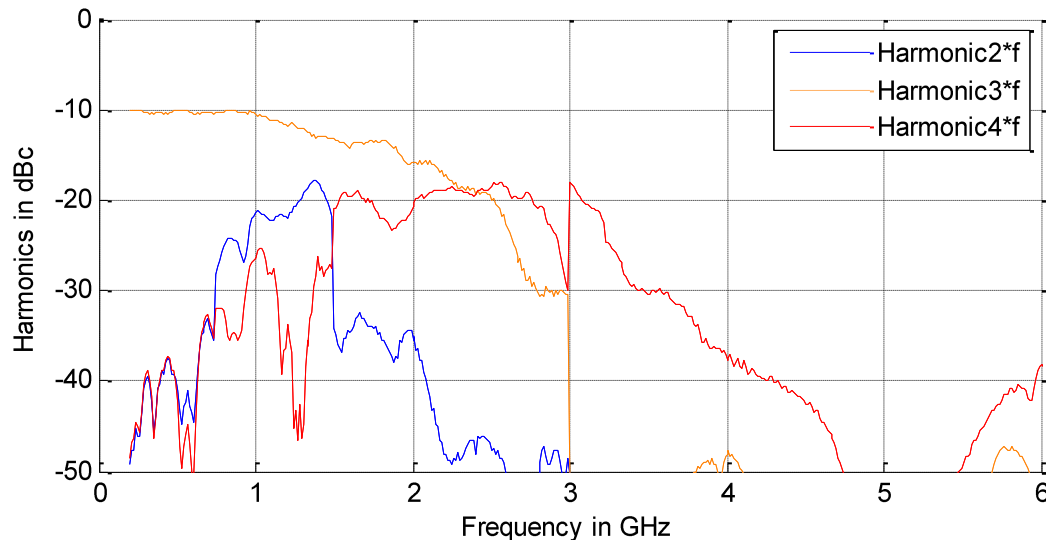

Fig. 3-7 Measured harmonics in mode I/Q modulation at X216 of the RF Board

Subharmonics and nonharmonics should be lower than -60 dBc relative to the carrier. If the harmonic or nonharmonic suppression isn't met most probably the RF Board is defective. Check the supply voltages and the control signals of the RF Board (see page 3.38). If they are OK replace the RF Board (see page 3.88).

RFMOD: I/Q modulated signal from Vector Board to RF Board

The I/Q-modulated signal is routed back to the RF Board through the semi rigid cable W211. The levelling of the I/Q modulated signal is done on the Vector Board, so the output level varies corresponding to the output level of the R&S SMBV. Set the R&S SMBV to:

- Instrument Preset
- Reference internal
- RF on
- I/Q-Mod ⇒ Analog I/Q wideband in
- I/Q-Mod: state on
- Supply a DC-voltage of 0.5 V to the I-Input BNC-connector
- RF/A Mod ⇒ Automatic Level Control ⇒ ALC state on.

Disconnect W211 from X511 on the Vector Board and measure the output level. The ALC loop is now open and the leveling unit raises the Vector Board level to the maximum available level. At room temperature ($\approx 23^\circ\text{C}$) the output level should be within ± 4 dB of the output level of a typical Vector Board shown in [Fig. 3-8](#).

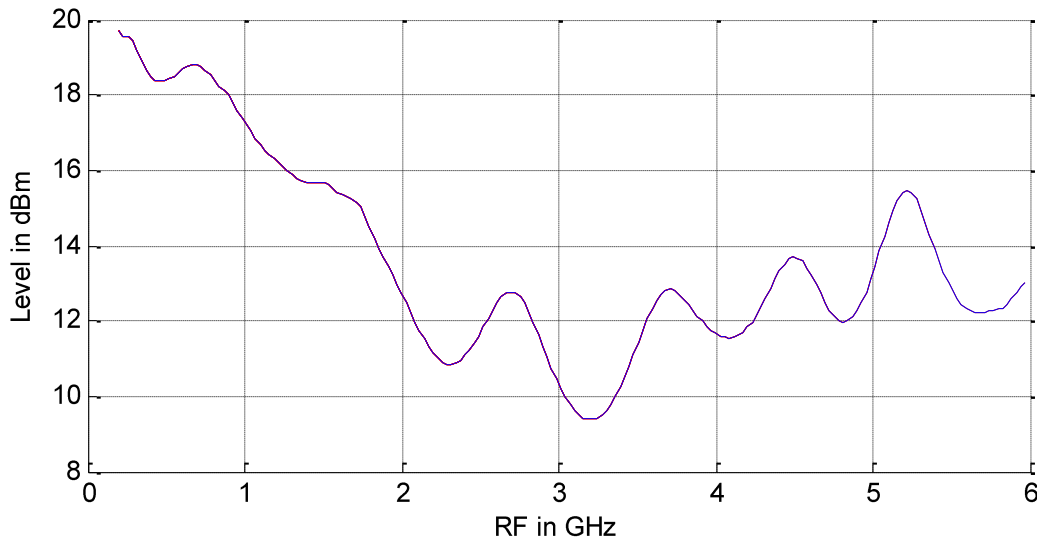

Fig. 3-8 Measured maximum output level at the X511 connector of the Vector Board

If the level is too low most probably the Vector Board is defective. Check the supply voltages and the control signals of the Vector Board (see page 3.44). If they are OK the Vector Board is defective and has to be replaced (see page 3.78).

To measure the harmonic spectrum set the ALC state to Table:

- RF/A Mod ⇒ Automatic Level Control ⇒ ALC state off (Table)
- RF/A Mod ⇒ Level/EMF ⇒ Attenuator Setting ⇒ mode fixed

Adjust the level setting of the instrument so, that the output level at the RF frequency is +5 dBm. The harmonic at the frequency $2 * RF$ should be at least 25 dB lower than the fundamental at RF. The levels of higher harmonics are not as important, because their level is reduced on the RF Board by lowpass filters. At Fig. 3-9 the harmonics of a measured R&S SMBV at 0 dBm level at X511 are shown.

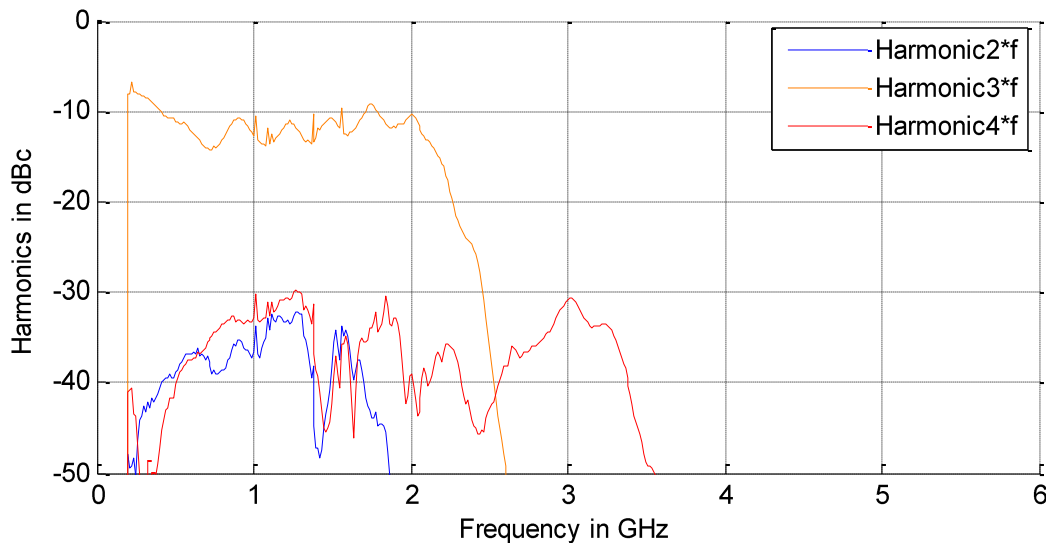

Fig. 3-9 Measured harmonics at X511 with 0 dBm output level

If the harmonics are out of tolerance check the supply voltages of the Vector Board (see page 3.44). If they are OK the Vector Board is defective and has to be replaced (see page 3.78).

Troubleshooting – Basis Board Module and Power Supply

Supply Voltages

Before Troubleshooting the Basis Board switch the R&S SMBV on and measure the supply voltages at the pins of its power supply connector (X101, see [Fig. 3-10](#)) and at the test points and compare them to the values specified in the table below. Pin 13 is the Power On-Signal for the power supply. As long as the voltage at this pin is +5 V the power supply is switched off. The power supply is turned on by assigning 0 V to this pin. If one or more voltages are not of the required level, the power supply is defective.

Pin at X101	Test Point	Fuse	R&S SMBV in standby mode	R&S SMBV switched On
5...10	+5V (1)	F4	0 V	+4.7 V ... +5.3 V
5...10	+5V (2)	F7	0 V	+4.7 V ... +5.3 V
3, 4	+13V2 (1)	F3	0 V	+12.4 V ... +14.2 V
3, 4	+13V2 (2)	F5	0 V	+12.4 V ... +14.2 V
2	-13V2	F6	0 V	-14.2 V ... -12.4 V
1	+5V_STBY	F9	+5V V	+4.7 V ... +5.3 V
13			> +3 V	< 0.8 V
14...20			GND	GND
	+28V		0 V	+25.8V ... 30.2V
	+7V		0 V	+6.4V ... +7.6V
	+3V3		0 V	+3.1V ... +3.5V
	+3V0		0 V	+2.85V ... +3.15V
	+2V5		0 V	+2.3V ... +2.7V
	+1V8		0 V	+1.7V ... +1.9V
	+1V2		0 V	+1.15V ... +1.25V
	-7V		0 V	-7.6V ... -6.4V

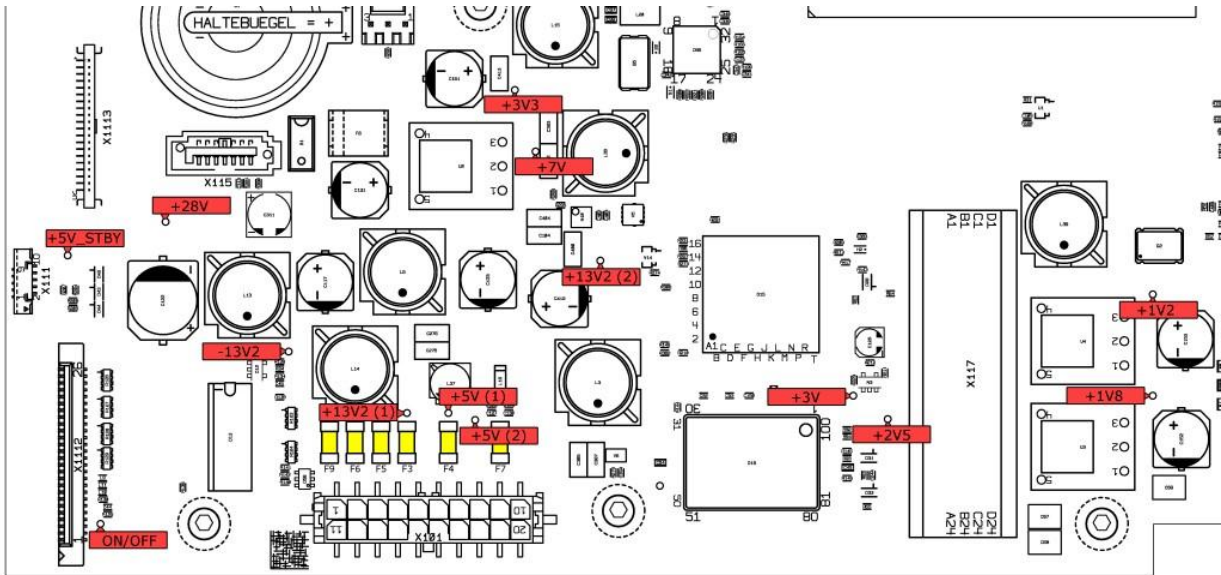

Fig. 3-10 Power Supply Connector of the Basis Board 2

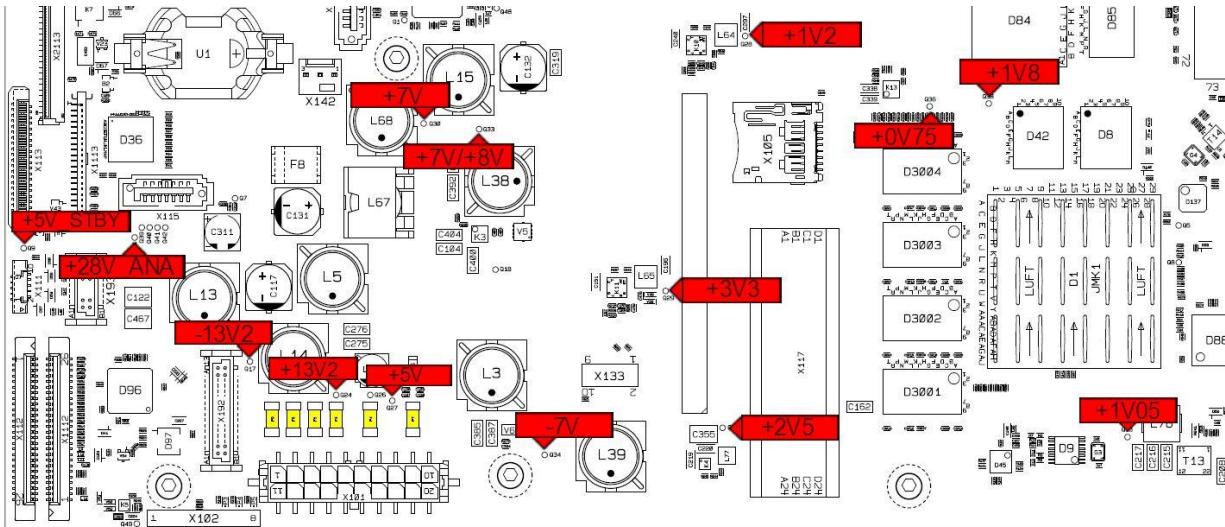

Fig. 3-11 Power Supply Connector of the Basis Board 4

Fuses

Switch on the R&S SMBV and measure the voltage drop across the fuses F3 – F7 and F9 (yellow marked see Fig. 3-10) with a multimeter. The voltage across every fuse should be in the range -100 mV ... +100 mV. The fuses might be blown due to a defective module other than the Basis Board. If one of the fuses is blown replace the fuse with the correct type given below. Remove connection W222 to the RF Board and W113 to the display. Switch on the R&S SMBV and check the voltage drop across the fuses after two minutes again. If one of the fuses is blown again the Basis Board is defective. If the fuses are OK switch of R&S SMBV again and then connect the display and switch on the R&S SMBV again. If one of the fuses is blown after two minutes and the display is not working the display is defective. If the RF Board is equipped with the Reference Oscillator B1/B1H remove this unit first (see page 3.102). Now repeat the fuse test by first adding the connection to the RF Board and then adding the Reference Oscillator B1/B1H. The module causing the blown fuse is defective.

Fuse	Type	R&S Part Number	Manufacturer Part Number
F3	T5A	1090.4442.00	Littlefuse R452.005 NRL (MRL)
F4	FF10A	6104.9199.00	Littlefuse R452.010 NRL (MRL)
F5	T5A	1090.4442.00	Littlefuse R452.005 NRL (MRL)
F6	T5A	1090.4442.00	Littlefuse R452.005 NRL (MRL)
F7	FF10A	6104.9199.00	Littlefuse R452.010 NRL (MRL)
F9	T5A	1090.4442.00	Littlefuse R452.005 NRL (MRL)

Troubleshooting – RF Board module

The tests listed below ensure that an assumed error on the RF Board module is not caused by a defective or incorrectly connected cable, incorrect adjustment or another module.

A comprehensive test of the module is to run the internal selftest and the internal adjustments. See chapters '[Troubleshooting using Internal Selftest](#)' (page 3.20) and '[Troubleshooting using Internal Adjustments](#)' (page 3.24).

Supply Voltages

Remove the RF Board from the chassis and connect cable W222 from the Basis Board. Switch on the R&S SMBV and measure the supply voltages of the RF Board at the series coils near its power supply connector (X222, see [Fig. 3-12](#)). The measured voltages have to meet the values given in the table below. If one or more voltages are not of the required level, check the Basis Board (see page 3.35).

Measuring Point	R&S SMBV switched On
Shielding enclosure	GND
L6004	+3.1 V ... + 3.5 V
L6001	+6.5 V ... +7.5 V
L6000	+12 V ... +14 V
L6002	-14 V ... -12 V
L6003	+26 V ... + 30 V

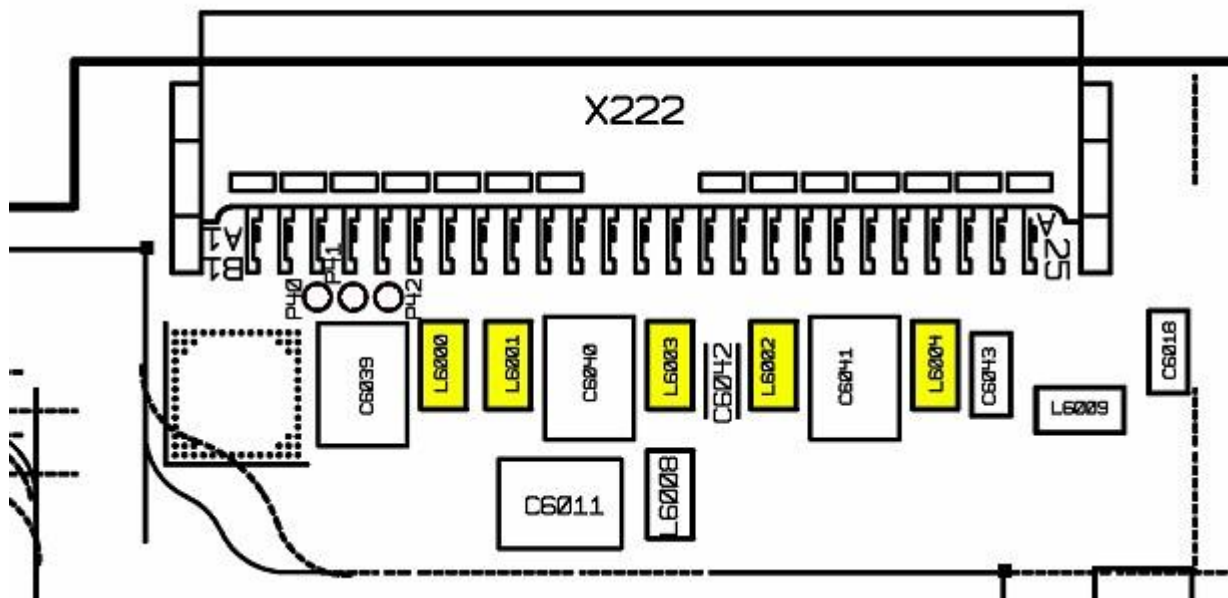

Fig. 3-12 Power Supply and digital interface connector of the RF Board.

Control Signals

The control signals of the RF Board can be measured at test points near connector X222 (see [Fig. 3-13](#)). Signals going to the RF Board are colored red and signals coming from the RF Board are colored blue.

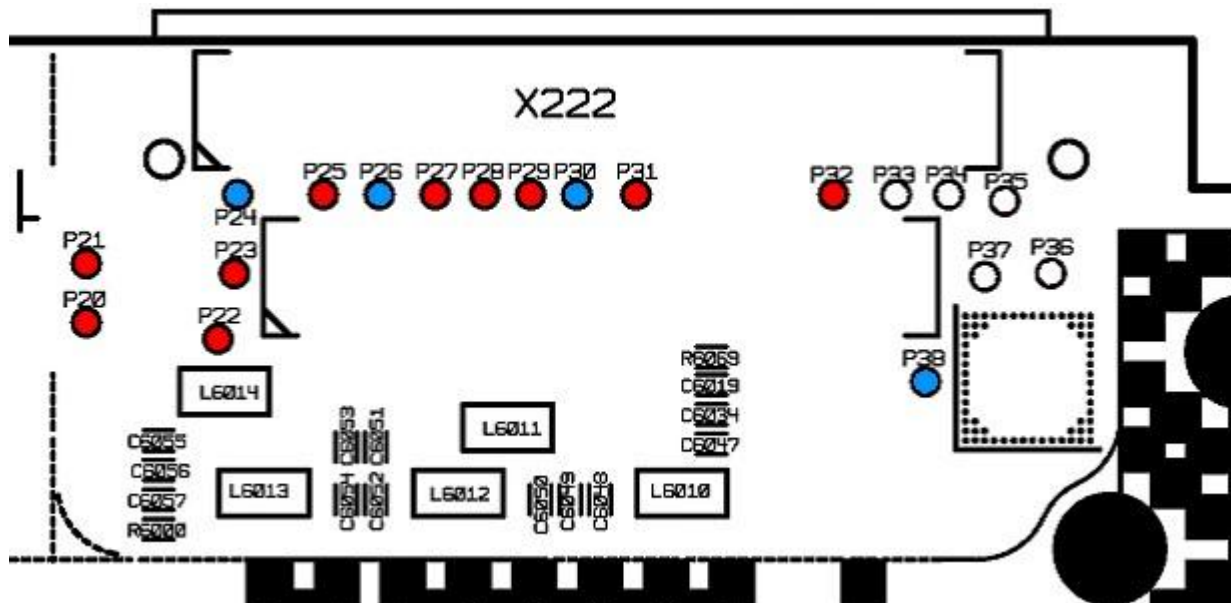

Fig. 3-13 Signal Test Points of the RF Board.

Perform the following settings at the R&S SMBV:

- Preset
- RF on
- Unlock Protection Level 2: 147946
- **SETUP** - Test Point ⇒ Select Test Point ⇒ DIAG_SMB_RF_LCON
- **SETUP** - Test Point ⇒ State ⇒ on

Preset the R&S SMBV and control the following signals with an Oscilloscope.
Oscilloscope settings:

- Voltage: 1V / Div
- Timespan: 1 μ s / Div
- Trigger: Normal

Measure these signals:

Test point	Function	Signal at normal operation	Defective
P23, P25, P27, P28	Logic Control Signals	Check the serial number of the RF Board displayed in the GUI: <input type="button" value="SETUP"/> - Hardware-Config – RF Board - More... If the number is correct these signals are OK. If not measure these Test-Points with an Oscilloscope: They should toggle between 0 V and 3.3 V	Basis Board
P26	Logic Control Signal		RF Board
P29, P31	Reset	3.3 V	Basis Board
P30	Interrupt Signal	normal Operation: 3.3 V Switch R&S to Reference extern without applying 10 MHz Reference signal: 0 V	RF Board
P32	Blank Signal	normal Operation: 0 V during Frequency switching: + 3,3 V	Basis Board
P38	Diagnosis Voltage	Voltage toggles on every update of the diagnosis between 0 V and about 1/5 of the Diagnosis voltage reading in the Display	RF Board
P20, P21, P22	Logic Control Signals	Check the serial number of the MOD-FPGA displayed in the GUI: <input type="button" value="SETUP"/> - Hardware-Config – MOD-FPGA - More If the number is not 0.0 these signals are OK. If not measure these Test-Points with an Oscilloscope: They toggle between 0 V and 3.3 V during the first seconds after switching on the instrument	Basis Board
P24	Logic Control Signal		RF Board

If one of these Signals is not as described change the connector cable and test again. If the signals still not match their description change the defective board according to the table.

Input and Output Signals

Connector, system	Signal name	Setting on signal generator	Frequency	Level	Signal flow
X212, SMA	RF out	RF on	9 kHz to 6 GHz	-145 dBm to +30 dBm	to N RF connector at front
X216, SMA	Lo	RF on, IQ on	200 MHz to 6 GHz	8 dBm to 20 dBm	to Lo in of Vector Board
X211, SMA	RF_MOD	RF on, IQ on, Wideband-IQ in: on, 0.5 V DC at I-input	100 kHz to 6 GHz	-40 dBm to +20 dBm	Vector modulated signal from Vector Board
X215, SMP	LFGEN	LF out on	0.01 Hz to 1 MHz	0 V to 3 V	to LF out at front
X214, SMP	MOD EXT	AM/FM/PM Source Ext	0.0 to 1 MHz	-1 V to +1 V	From Mod ext at front
X213, SMP	REF200		200 MHz DC	4+-2 dBm 0 - 10 V	200 MHz Reference signal and level control voltage for Vector Board

Error Messages concerning the RF Board Module

Error message	Error correction
"ALC unlocked"	<ul style="list-style-type: none"> ➤ Automatic Level Control ALC exceeds upper bound. ➤ Set attenuator mode "Auto".
"Synthesis main-loop PLL unlocked"	<ul style="list-style-type: none"> ➤ Execute Internal Adjustment "Adjust Synthesis". ➤ If the error message does not disappear change the module.
"Synthesis adjustment failed"	<ul style="list-style-type: none"> ➤ Execute Internal Adjustment "Adjust Synthesis". ➤ If error messages does not disappear, check the diagnosis (see Troubleshooting using Internal Test Points). If the diagnosis measurements work change the RF Board.
"Synthesis adjustment data invalid"	<ul style="list-style-type: none"> ➤ Execute Internal Adjustment "Adjust Synthesis". ➤ If the error messages does not disappear, check the diagnosis (see Troubleshooting using Internal Test Points). If the diagnosis measurements work change the RF Board.

Warnings concerning the RF Board Module

Warnings	Warning correction
"External reference oscillator out of range or disconnected"	<ul style="list-style-type: none"> ➤ Check the external reference input signal. ➤ If the input signal is correct and the error message is still displayed, change the module.
"Output protection tripped"	<ul style="list-style-type: none"> ➤ Excessive reverse power at the RF port tripped the output protection. ➤ Remove the overload condition and press the "RF ON/OFF" button to enter normal operation.
"Pep value greater than defined limit"	<ul style="list-style-type: none"> ➤ The peak envelope power (PEP) is higher than the set upper limit. ➤ Reduce the output level.
"Pep value less than defined lower bound (fix range)"	<ul style="list-style-type: none"> ➤ The peak envelope power (PEP) is lower than the permissible lower limit in the "fix range" mode of the attenuator. ➤ Increase the output level, set the attenuator mode to "Auto", or reset the "fix range" by briefly switching the attenuator mode to "Auto" and then switching back to "Fixed".
"Pep value greater than defined upper bound (fix range)"	<ul style="list-style-type: none"> ➤ The peak envelope power (PEP) is higher than the permissible upper limit in the "fix range" mode of the attenuator. ➤ Reduce the output level, set the attenuator mode to "Auto", or reset the "fix range" by briefly switching the attenuator mode to "Auto" and then switching back to "Fixed".
"Settings conflict, pep value vs. AM depth"	<ul style="list-style-type: none"> ➤ The peak envelope power (PEP) is higher than the permissible upper limit because of the set AM modulation depth. ➤ Reduce the output level or increase the level limit (e.g. by switching the attenuator mode to "Auto" if "Normal" or "Fixed" mode was set). Reducing the AM modulation depth will also eliminate the warning.
"Settings conflict, pep value greater than allowed level vs. frequency"	<ul style="list-style-type: none"> ➤ The full output level range cannot be utilized at low frequencies below 1 MHz. because internal components may be overloaded. So you can only set max. +16 dBm CW level below 1 MHz and max. +8 dBm CW level below 50 kHz.
"Settings-conflict: PulseGen"	<ul style="list-style-type: none"> ➤ Settings for the internal pulse generator are incorrect. Check timing settings of the pulse generator

Frequency error

Error	Error correction
Internal reference frequency: Frequency error greater than limit given in datasheet	<ul style="list-style-type: none"> ➤ The frequency accuracy of the synthesizer is determined (set to internal reference) by a highly stable 200 MHz quartz oscillator that is set to a calibrated frequency standard at the R&S factory. This oscillator is subject to ageing and can be recalibrated (see chapter 2 “Internal Counter Reference Oscillator Adjustment”). <hr/> <p>Note: <i>The internal reference can be impaired under the menu Setup - Reference Oscillator - Adjustment. This setting does not affect the factory adjustment and can be reset at any time by means of deactivation. If the tuning rang is insufficient to reach the frequency error given in the datasheet the TCXO is defective. Replace the RF Board.</i></p>

Troubleshooting Vector Board

For tracing down errors associated with the Vector Board, it might be helpful to measure voltages and signals on the Vector Board connector. As the pins of this connector are hardly accessible if the R&S SMBV is assembled, it is recommended to measure the corresponding signals on the rear side of the LI bridge. Please consult the following photograph to allocate the pins. Be careful not to short circuit any adjacent pins!

Rear side of Vector Board connector on the LI Bridge (seen from the BBGEN board):

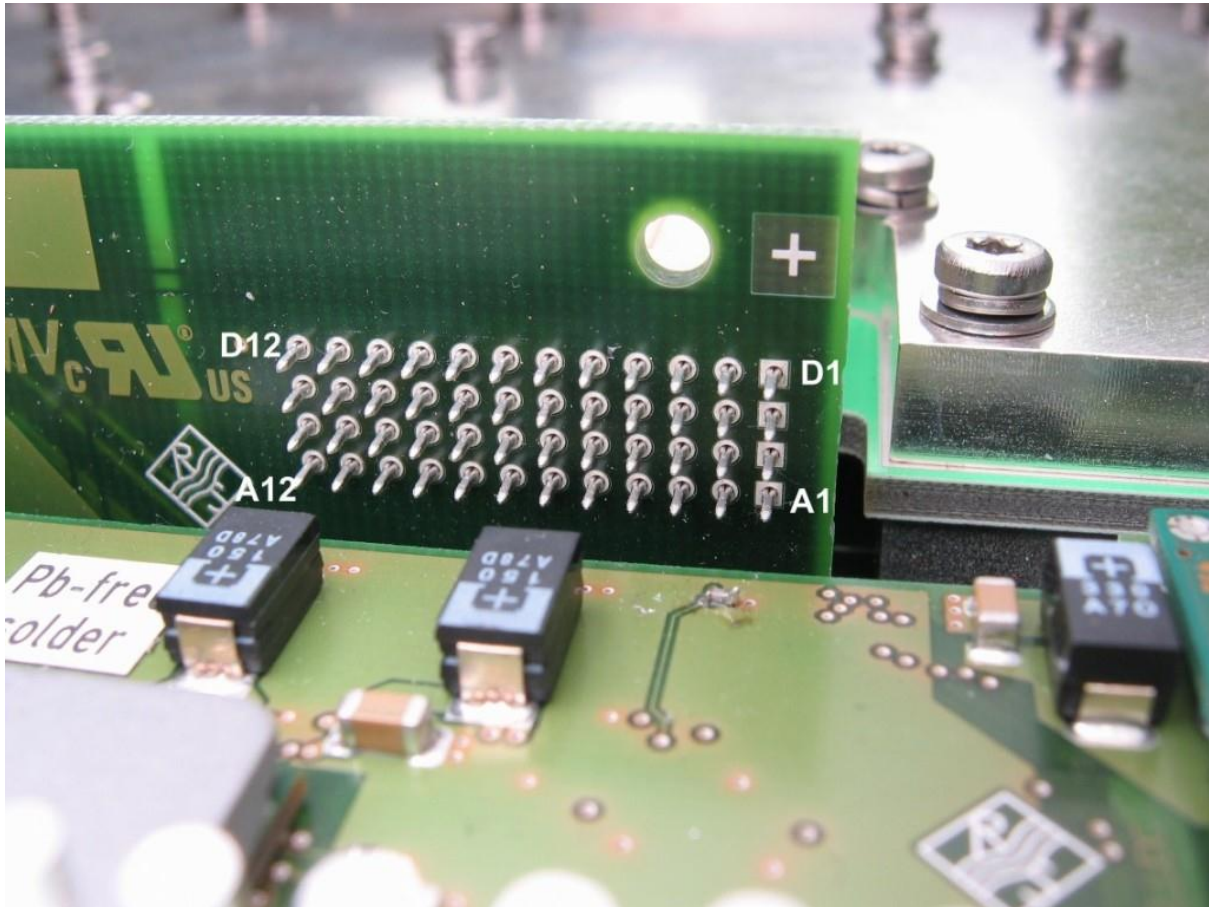

(Pin numbering in white only on photograph, not on printed circuit board)

Vector Board is not detected

If the Vector Board is not listed in the Setup→Hardware Config list, it might be due to the following reasons:

CAUSE: Logic supply voltage is missing.

VERIFY: Measure +5 V @ X522 / Pin B9. It should be within 4.7 V – 5.3 V

ACTION: If +5 V voltage is missing, check Basis Board or LI Bridge

CAUSE: Serial Bus communication is disturbed.

VERIFY: Measure SER_CLK (Pin A4), SER_STROBE_A (Pin B1), SER_STROBE_D (Pin B2) and SER_IN (Pin B5) at X522. They should toggle between 0V and +3.3V logic level during data transfer. Data transfer will occur during the boot up device scan sequence.

- ACTION:** If any of these lines does not toggle at any time, check Basis Board or LI Bridge.
- CAUSE:** Serial Bus decoder defective or FlashPROM header missing.
- VERIFY:** Check supply voltage and communication as described above.
- ACTION:** Replace Vector Board.

Vector Board self diagnosis run shows errors on supply voltage(s)

If the Vector Board is detected by the instrument but the supply voltages show any failures, please proceed as follows:

- ISSUE:** All supply voltages on the Vector Board diagnosis are 0 V.
- CAUSE:** Either all the supply voltages are missing or the diagnosis line between the Vector Board and Basis Board is broken.
- VERIFY:** Check supply voltages on X522.
- Measure diagnosis voltage on X522 / Pin C1 while selecting different voltage test points via R&S SMBV firmware. The voltage should fluctuate.
- ACTION:** If the supply voltages are within specification but the diagnosis voltage is missing, replace Vector Board. If the diagnosis voltage is available, check LI bridge or Basis Board.
- ISSUE:** Some supply voltages on the Vector Board are out of tolerance.
- VERIFY:** Check if the supply voltages are in accordance with the following specification:

Supply name	Pin on X522	Specification
-12 V	D10, D11	-11 V ... -14 V
-7 V	C9, C10, C11	-6 V ... -8.5 V
+5 V	B9	+4.5 V ... +6 V
+7 V	A8, A9, A10, A11	+6 V ... +8.5 V
+12 V	B10, B11	+11 V ... +14 V
+28 V	A6	+26 V ... +30 V

- ACTION:** If any supply voltage is out of specification, check LI bridge and Basis Board. If all voltages are within specification, replace Vector Board.

Troubleshooting BBGEN-Board

If the BBGEN Board cannot be configured properly the baseband block will not appear in the block diagram on the instrument screen.

Error message	Error correction
"Baseband Board FPGA boot failed!"	<ul style="list-style-type: none"> ➤ Check supply voltages ➤ Check internal voltages for FPGA ➤ If this message does not disappear, replace BBGEN-Board
"Baseband Board clock detection failed!"	<ul style="list-style-type: none"> ➤ Check SMP adaptor is plugged in correctly ➤ Check orientation of SMP adaptor ➤ Check if BBGEN Board is installed properly ➤ If this message does not disappear, replace BBGEN-Board

Supply Voltages

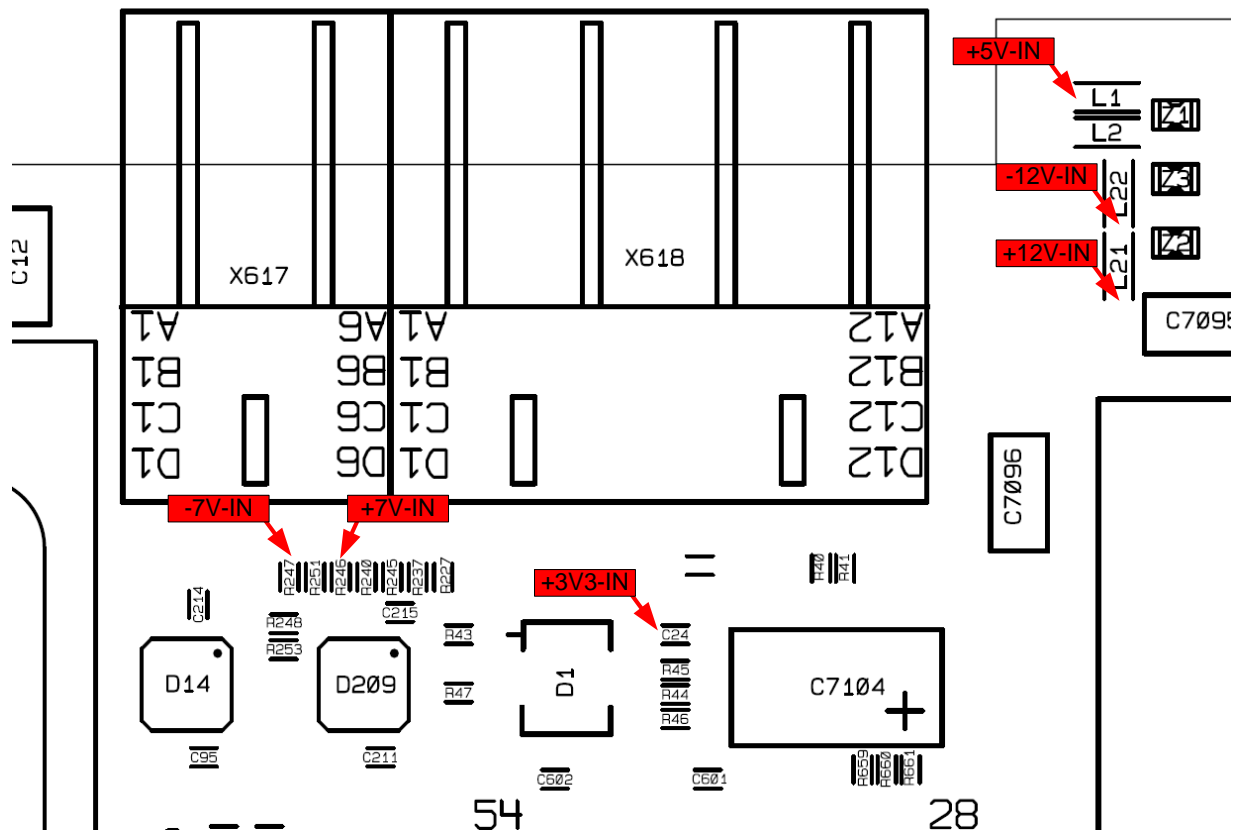

Check if the supply voltages are in accordance with the following specification:

Name	Specification
+5V-IN	+4.5 V ... +6 V
+3V3-IN	+3.0 V ... +3.6 V
+7V-IN	+6 V ... +8.5 V
-7V-IN	-6 V ... -8.5 V
+12V-IN	+11 V ... +14 V
-12V-IN	-11 V ... -14 V

Supply Voltages for the FPGA

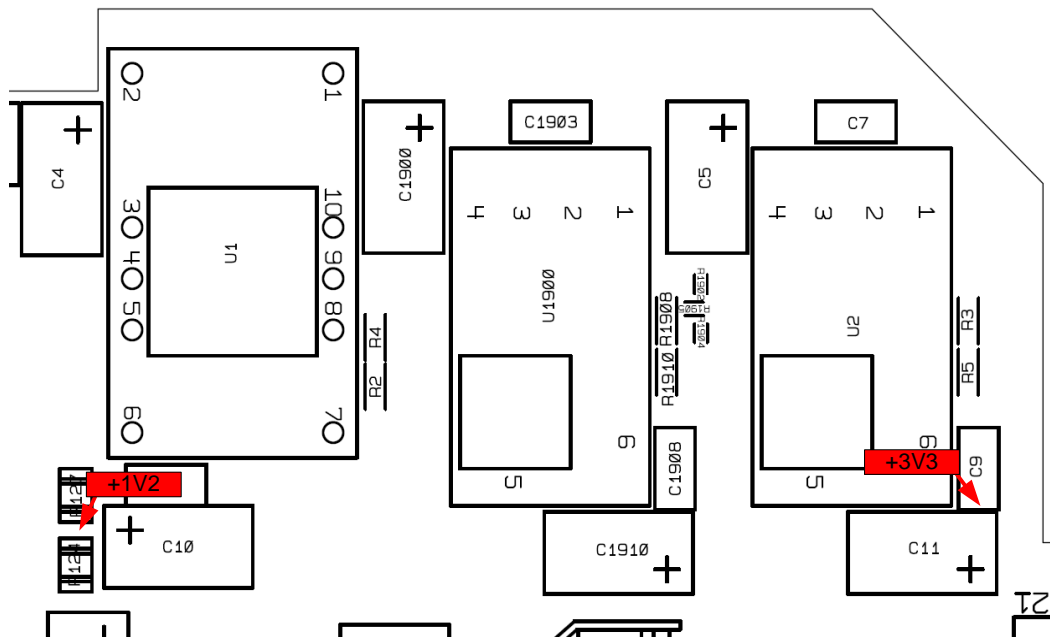

Check if the supply voltages for the FPGA are in accordance with the following specification:

Name	Specification
+1V2	+1.15 V ... +1.25 V
+3V3	+3.0 V ... +3.6 V

Faulty Signal Generation in the Baseband

- **Error: Vector Signal Generator does not supply correct baseband signal (at I+Q output sockets on rear panel and/or the digital modulation is disturbed).**

Normal action	Test
<p>The baseband signal is generated on the BBGEN Board. Located on this board are the D/A converters, which feed analog signals into the rear panel sockets and to the Vector Board.</p> <p>The Graphics toolbox in the block diagram uses data from the BBGEN Board for generation of the constellation diagram and the power spectrum.</p>	<ul style="list-style-type: none"> ➤ Setting on Vector Signal Generator: <ul style="list-style-type: none"> Baseband/ARB/Sine Test Signals... Frequency 25MHz Samples per Period 4 Phase Offset Q 90 Generate Signal RAM Close window "Sine Test Signals" State On ➤ Graphics/Graphic Settings <ul style="list-style-type: none"> Mode Power Spectrum <p>A clean power spectrum with one frequency at +25MHz should appear. If not, the BBGEN Board is faulty.</p> <ul style="list-style-type: none"> ➤ Setting on Spectrum Analyser: <ul style="list-style-type: none"> Preset Center 50MHz Span 100MHz Reference Level 5dBm Res BW 300kHz ➤ Connect subsequently a Spectrum Analyser to the BNC-Output I, IN, Q and QN <p>A clean spectrum with one frequency at 25MHz should appear. If not, the BBGEN Board is faulty.</p>

Troubleshooting LI Bridge

Due to the low component count, failure of the LI Bridge is very unlikely.

However, a loose connection at any of the pressfit mounted connector pins might result in intermittent or permanent failures at the Vector Board or BBGEN Board that might be difficult to track down.

If the LI Bridge is suspected to cause an issue, optical inspection of the connector pins is advisable. Furthermore, the fastest solution might simply be to replace the LI Bridge Board and watch closely if the problem persists.

Troubleshooting – Reference Oscillator option R&S SMBV-B1/-B1H

If the frequency Error of the R&S SMBV is $> 3 \cdot 10^{-6}$ the Reference Oscillator is defective, change the module.

Input and Output Signals

The Reference Oscillator has only one Futurbus connector (X1). The Reference Oscillator is plugged into the RF Board (X221 see [Fig. 3-14](#)). All signals and the supply voltage are fed to the module through this connector. Check the voltages for the OCXO being according to the following table. To test the serial bus signals watch the signal lines while toggling between internal and external reference with an Oscilloscope. Voltage Levels are 0 V and 3.3 V.

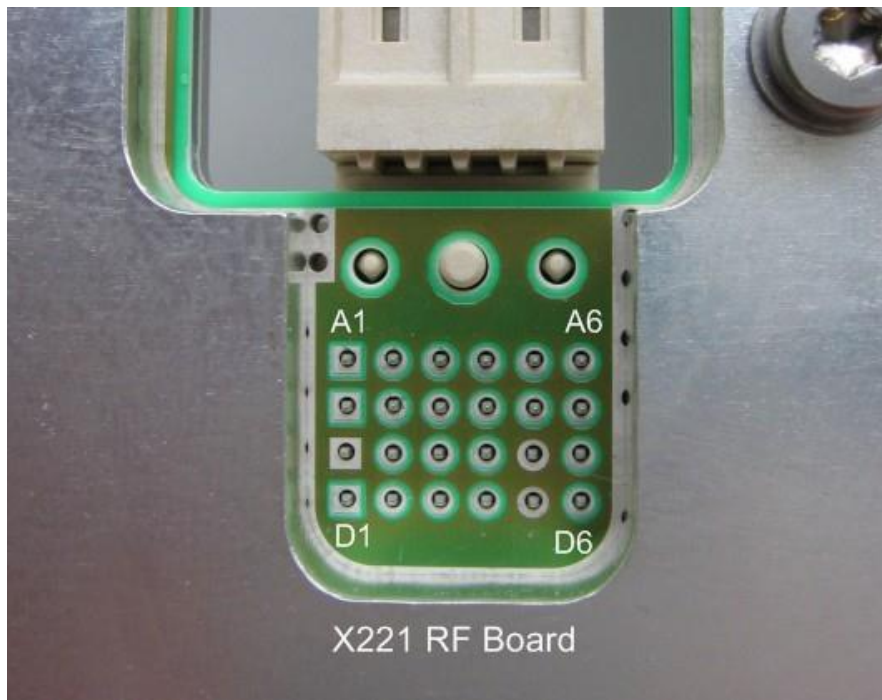

Fig. 3-14 Pin location X221 on RF Board

Pin of X221 RF Board	Voltage/Signal	Pin of X221 RF Board	Voltage/Signal	Pin of X221 RF Board	Voltage/Signal	Pin of X221 RF Board	Voltage/Signal
A1	Clock-signal serial bus	B1	NC	C1	GND	D1	+4.8 V to +5.6 V
A2	Data-signal to option serial bus	B2	0 V when Oven Cold	C2	NC	D2	0 V when option fitted
A3	Chip Select signal serial bus	B3	Data-signal from option serial bus	C3	+5.0 V when option on	D3	10 MHz LVDS signal
A4	NC	B4	NC	C4	NC	D4	
A5	NC	B5	NC	C5	GND	D5	GND
A6	+4.8 V to +5.6 V	B6	+4.8 V to +5.6 V	C6	+11 V to +14 V	D6	-8 V to -12 V

Error Messages Concerning the Reference Oscillator Module

Error message	Error correction
" OCXO 10 MHz oven cold	➤ If this message does not disappear after 10 minutes, OCXO is defective, change the module.
"Synchronization error on internal reference"	➤ Switch the R&S SMBV to external Reference and supply a 10 MHz 10 dBm signal to the Reference Input of the RF Board. If the error disappears and the R&S SMBV is working correct the OCXO is defective, change the module.
"OCXO: cannot read EEPROM data" "OCXO: cannot store adjustment data"	➤ This indicates problems concerning the data transfer from and to the EEPROM of the module. If changing the module does not help, change the RF Board module.

Frequency Error, Reference Oscillator Adjustment

Error	Error correction
Internal reference frequency: Frequency error greater than limit given in datasheet	<p>➤ The frequency accuracy of the synthesizer is determined (set to internal reference) by a highly stable oven controlled 10 MHz quartz oscillator that is set to a calibrated frequency standard at the R&S factory. This oscillator is subject to ageing and can be recalibrated (see chapter 2 "Internal Counter Reference Oscillator Adjustment").</p> <hr/> <p>Note: <i>The internal reference can be tuned by up to approx. $\pm 10^{-6}$ under the menu Setup - Reference Oscillator - Adjustment. This setting does not affect the factory adjustment and can be reset at any time by means of deactivation.</i></p> <hr/>

Module Replacement

This section describes in detail the replacement of modules. Chapter 5 provides information on how to order spare parts; it contains the list of mechanical parts with order numbers and the illustrations for module replacement.

Required tools

- Star screwdriver TX 20
- Star screwdriver TX 8
- Star screwdriver TX 6
- Side cutter
- Flat pliers
- Forceps
- Tubular box wrench or a combination wrench (16 mm)
- Torque wrench (8 mm)

NOTICE Protection of mechanical components

Always use a torque wrench (60 Ncm) to screw all RF connectors. Do not use an open-end wrench.

Protection of electronic components

Always wear gloves when touching the electronic components.

Overview of the Modules

Table 3-1 Overview - module replacement

Module	Designation	Instrument Part No.	Replacement Part Order No.	See page
Power Supply (AC 90 V to 264 V)	A50	1406.7320.00	1406.7320.00	3.91
Basis Board 2 Basis Board 4	A100	1406.6700.02 1406.6900.02	1406.6700.02 1406.6900.02	3.80
RF Board	A200	1406.7207.03 1406.7207.13 1406.7220.03 1406.7220.13	1406.7220.13	3.88
		1406.7207.06 1406.7207.16 1406.7220.06 1406.7220.16	1406.7220.16	
R&S SMBV-B1 Reference Oscillator OCXO	A210	1407.8407.02	1407.8407.02	3.102
R&S SMBV-B1H Reference Oscillator OCXO	A210	1419.1602.02	1419.1602.02	3.102
Vector Board	A500	1407.7500.02	1407.7500.02	3.78
LI Bridge	A550	1407.7400.02	1407.7400.02	3.96
R&S SMBV Front Unit	A700	1407.8007.02 1407.8007.03 1407.8007.04	1407.8007.02 1407.8007.03 1407.8007.04	3.57
Encoder Board	A310	1300.3044.02	1300.3044.02	3.63
Flex. Switchboard	A320	1407.8020.00	1407.8020.00	3.63
TFT 6.5 VGA LVDS LED (display 6.5 inch)	A710	3583.2168.00	3583.2168.00	3.63

Module	Designation	Instrument Part No.	Replacement Part Order No.	See page
USB 2.0 Hub Board	A720	1407.7300.02	1407.7300.02	3.63
Fan Unit	E1	1407.6279.00	1407.6279.00	3.95
Lithium Battery CR 2477N (3.0 V / 0.95 AH)		4052.5673.00	4052.5673.00	3.100
R&S SMBV-B10/-B50/-B51 Baseband Generator	A600	1407.7000.02/03/03	1407.7000.02/03/03	3.77
R&S SMBV-B90 Phase Coherence		1407.9303.02	1407.9303.02	3.74
R&S SMBV-B92 Hard Disc	A750	1407.9403.02	1407.9403.02	3.73

Note: The words "left" and "right" in the manual always refer to the front view of the instrument.

NOTICE

When you replace the front unit or the basis board, please consider the variant. The dependencies are shown in the following table.

Table 3-2 Replacement Dependencies of Front Unit and Basis Board

Basis Board	Part No.	match to	Part No.
Basis Board 2	1406.6700.02	Front Unit Var. 02 Front Unit Var. 03	1407.8007.02 1407.8007.03
Basis Board 4	1406.6900.02	Front Unit Var. 02 Front Unit Var. 04	1407.8007.02 1407.8007.04

After replacing an assembly

After you have replaced one of the assemblies, certain adjustments, functional checks or performance tests have to be carried out. Please refer to chapter 2 “Procedures after module replacement”.

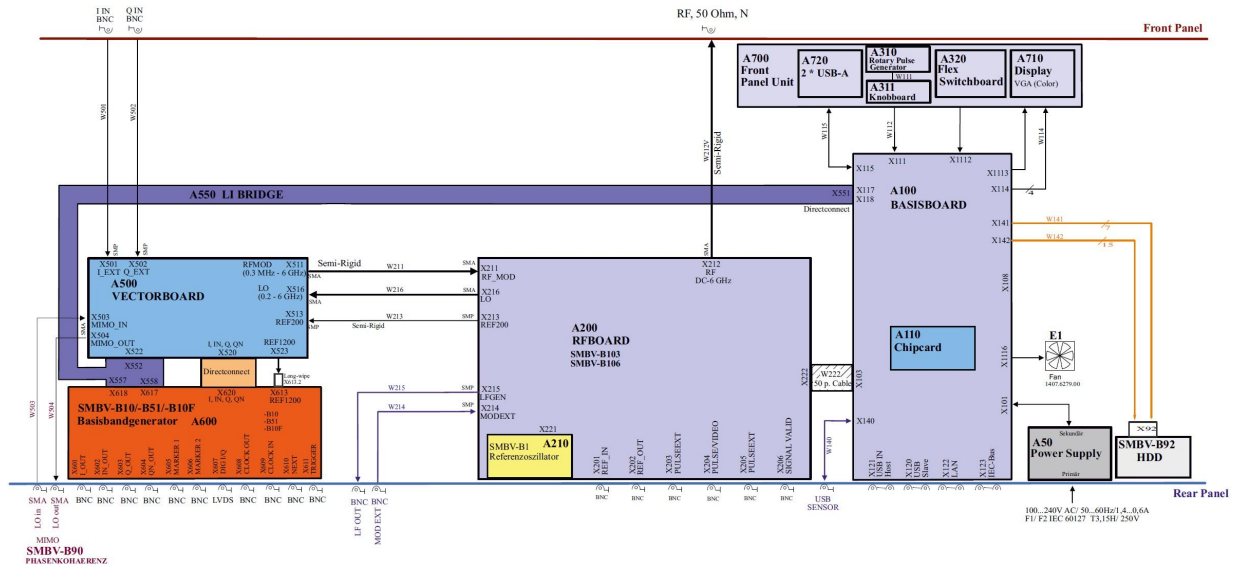

Safety Instructions

DANGER



Danger of injury

- For module replacement, ensure that the instrument is switched off and disconnected from the power supply. Remove the plug from the AC and DC power connector.
- Read all grouped safety messages carefully before module replacement.
- Only Rohde & Schwarz Service personnel and trained personnel may perform a module replacement.

With removed rear feet the instrument can slip out of the cabinet.

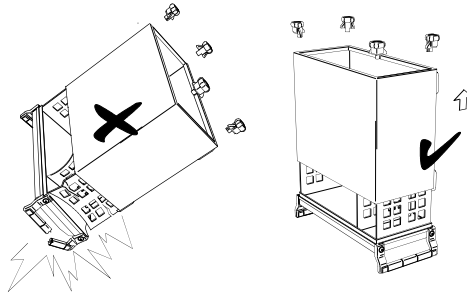

- To avoid the risk of injury and damage to the unit, put it into the front handles before removing the rear feet and taking off the cabinet.
- Do not pen in your fingers when mounting the cabinet. Also pay attention to the cables, which must not be damaged or pulled off. Affix the rear feet immediately after mounting the cabinet. Do not move the unit without the rear feet.

NOTICE

Protection of electronic components

Electrostatic discharge may cause damage to the electronic components of the instrument.

Protect your operational site against electrostatic discharge using one or both of the following methods:

- Wrist strap with cord to ground connection.
- Conductive floor mat and heel strap combination.

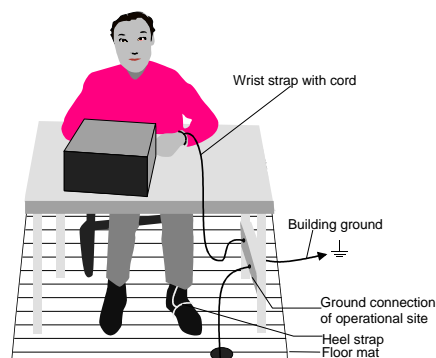

Dismounting the housing

- Put the instrument on the front shock mounts.
- Unscrew the four screws of the two protective rear shock mounts (rear right and rear left (740) and (730)) on both sides and take them off.
- Pull off the R&S SMBV cabinet (700).



Mounting the housing

- Put the instrument on the front shock mounts.
- Pull on the R&S SMBV cabinet (700).
- Take the two protective rear shock mounts (rear right and rear left (740) and (730)) on both sides on and screw the four screws.

NOTICE

When mounting the housing, take care not to damage or pull off cables.

Replacing Fuses

(see chapter 5, drawing and parts list 1407.6004.01).

NOTICE Replacement of fuses

Disconnect the mains cable before replacing the fuses. Always use the fuses supplied by Rohde & Schwarz as spare parts, or fuses of the same type and rating.

- Switch off the instrument.
- Disconnect the power supply cord.
- To replace a fuse, unscrew the fuse holder at the rear panel of the instrument.
- Pull the fuse off the fuse holder.

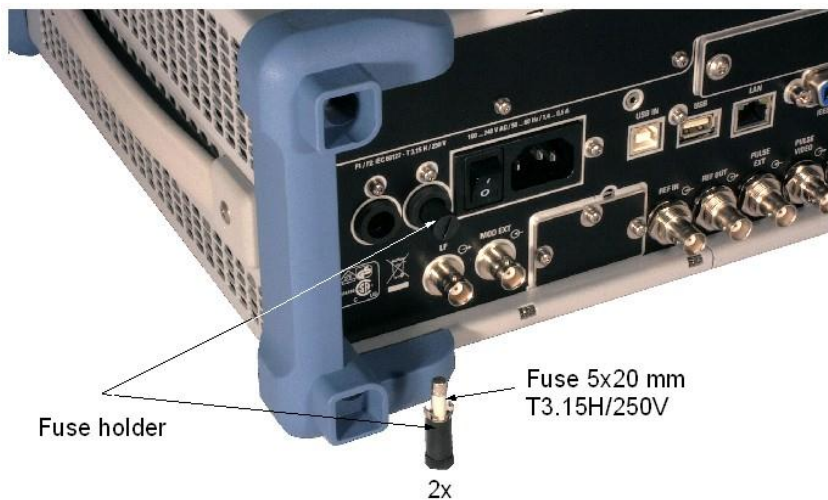

Installing Fuse

- Push the fuse into the fuse holder (Fuse 5 mm x 20 mm, T3.15H/250 V).
- Screw in the fuse holder at the rear panel of the instrument.

Replacing the Front Unit

(See chapter 5, drawing and parts list 1407.6004.01 / 1407.8007.01).

NOTICE The front unit variant depends on the basis board variant. For details see [Table 3-2](#) on page 3.52.

Removing the Front Unit

- Switch off the instrument and pull the mains plug.
- Dismount the cabinet (see page 3.55).
- Unscrew the four screws (725) and remove the left and right protective front corners (710 and 720).

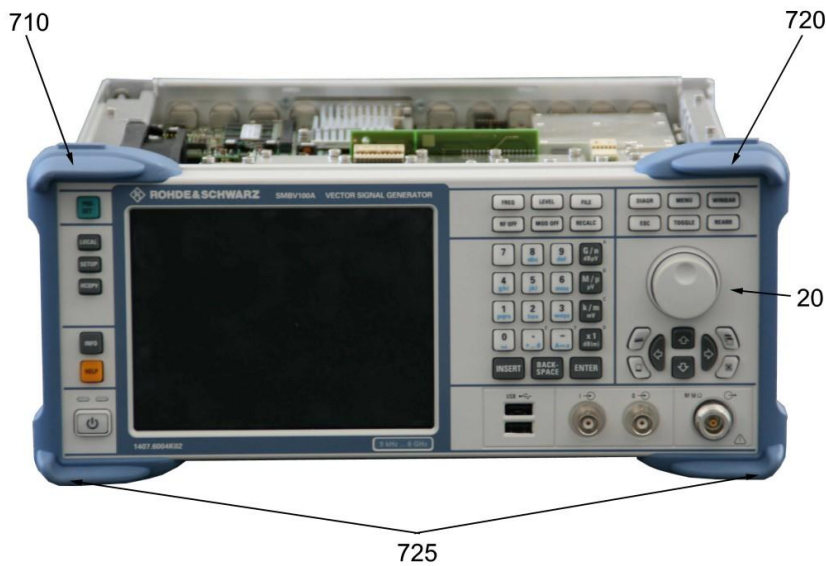

- Unscrew the four screws (210), two on the left and two on the right side from the front unit.

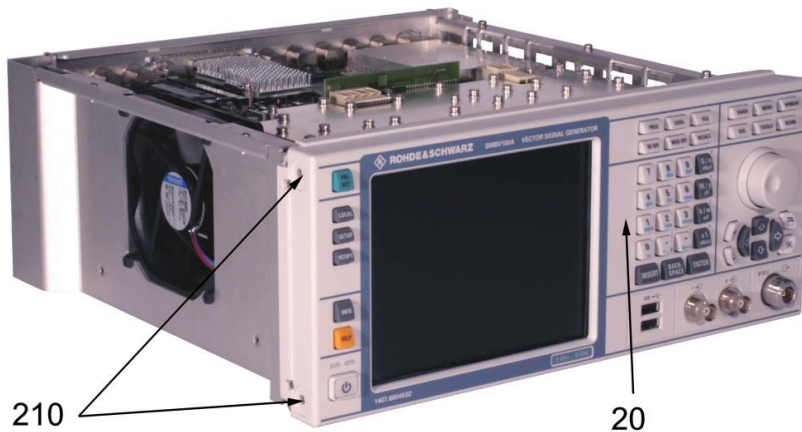

- Pull off the RF cable W212V (250).



- Pull off the RF cables W501 (422) and W502 (432).

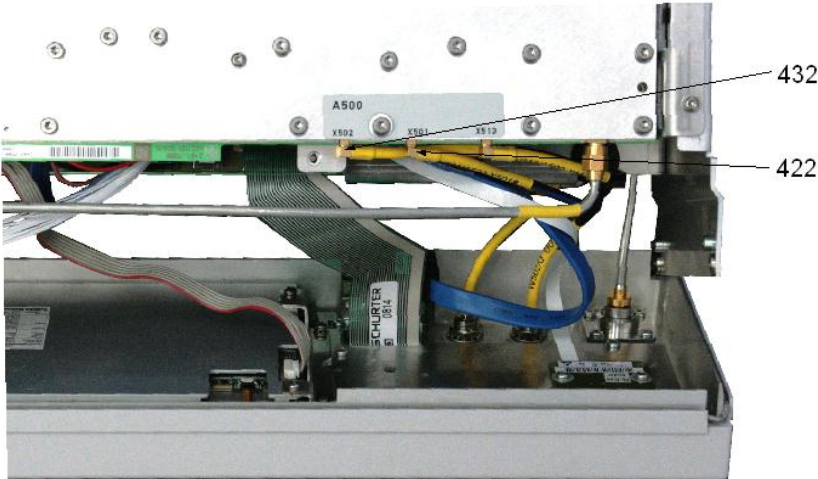

- Disconnect the SATA data cable W115 (270), the LCD LED input cable W114 (395), the flex strip 10-pin cable W111 (290), Toshiba display cable W113 (390) and the flex. switchboard cable A320 (50).

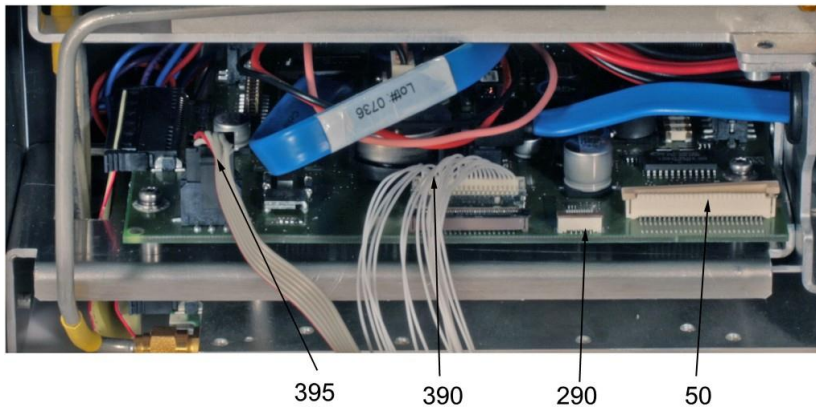
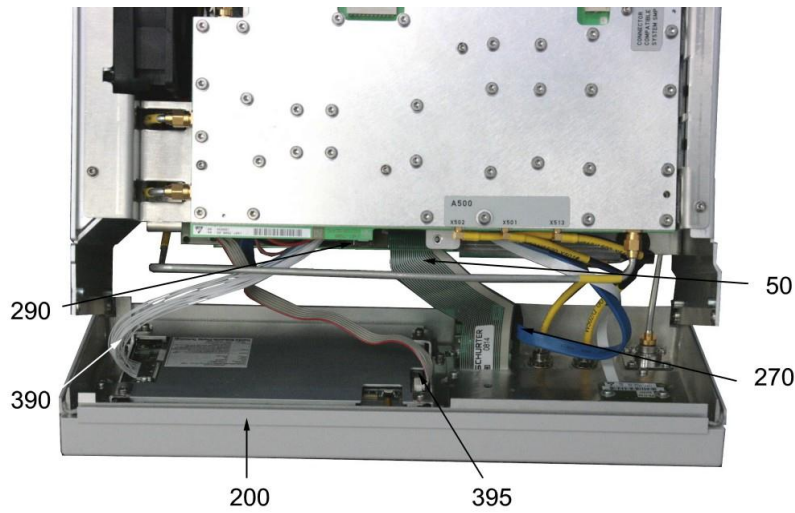

- Remove the front unit A700 (200) completely.

Installing the Front Unit

- Attach the front unit A700 (200).
- Connect the SATA data cable W115 (270), the LCD LED input cable W114 (395), the flex strip 10-pin cable W111 (290), Toshiba display cable W113 (390) and the flex. switchboard cable A320 (50).

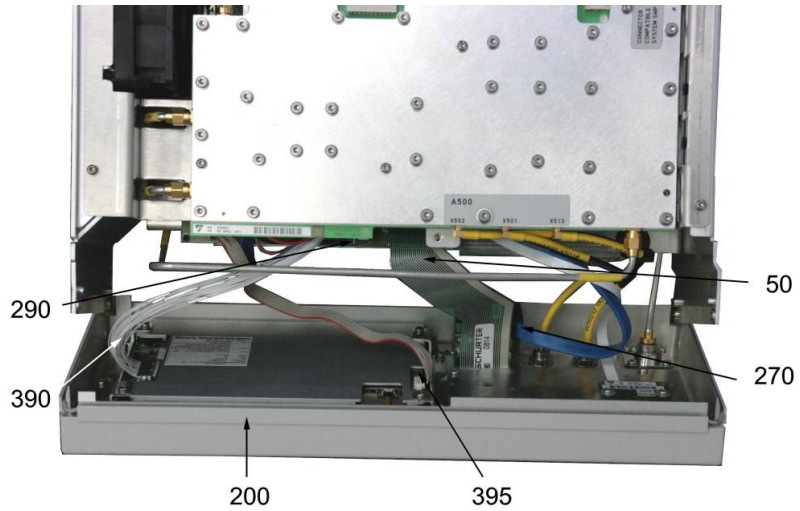
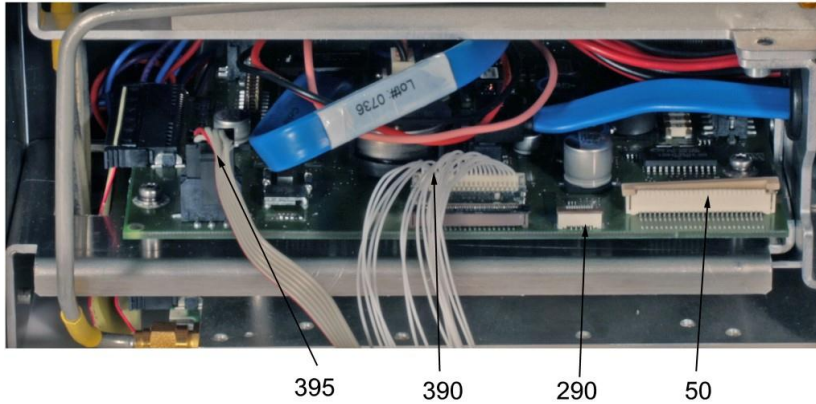

- Connect the RF cables W501 (422) and W502 (432).

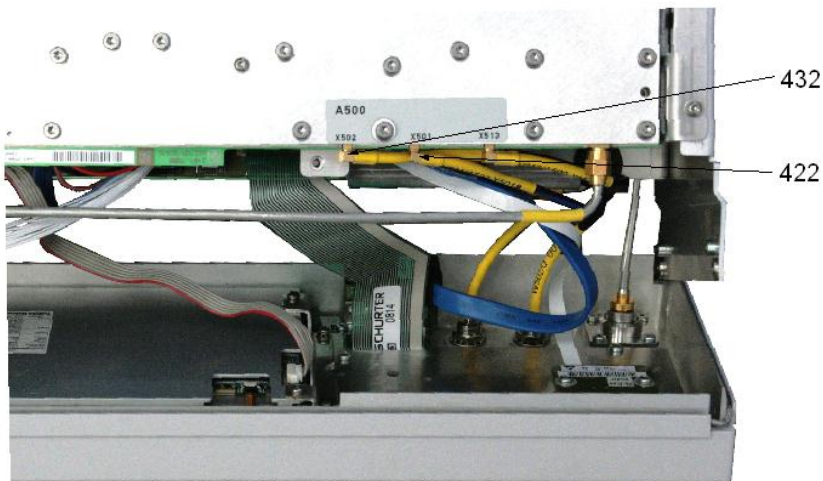

- Connect the RF cable W212V (250).



- Screw the four screws (210), two on the left and two on the right side, into the front cover R&S SMBV (20).



- Attach the left and right protective front corners (710 and 720) and screw fasten them with the four screws 1096.4909.00 (725).



- Mount the cabinet (see page 3.55).



Store the RF cables in a safe place. They are not part of the front unit.

NOTICE

Always use a torque wrench (60 Ncm) to screw all RF connectors. Do not use an open-end wrench.

When you mount the cables, ensure that they are correctly positioned in the front unit.

Replacing the TFT Display, Encoder Board, USB Hub Board, Flex. Switchboard, Pushbutton Board Set and the Screened Filter Glass

It is advisable to replace the front unit as a whole. However, the components of the front unit can be replaced individually (see figure below).

(See chapter 5, drawing and parts list 1407.8007.01).

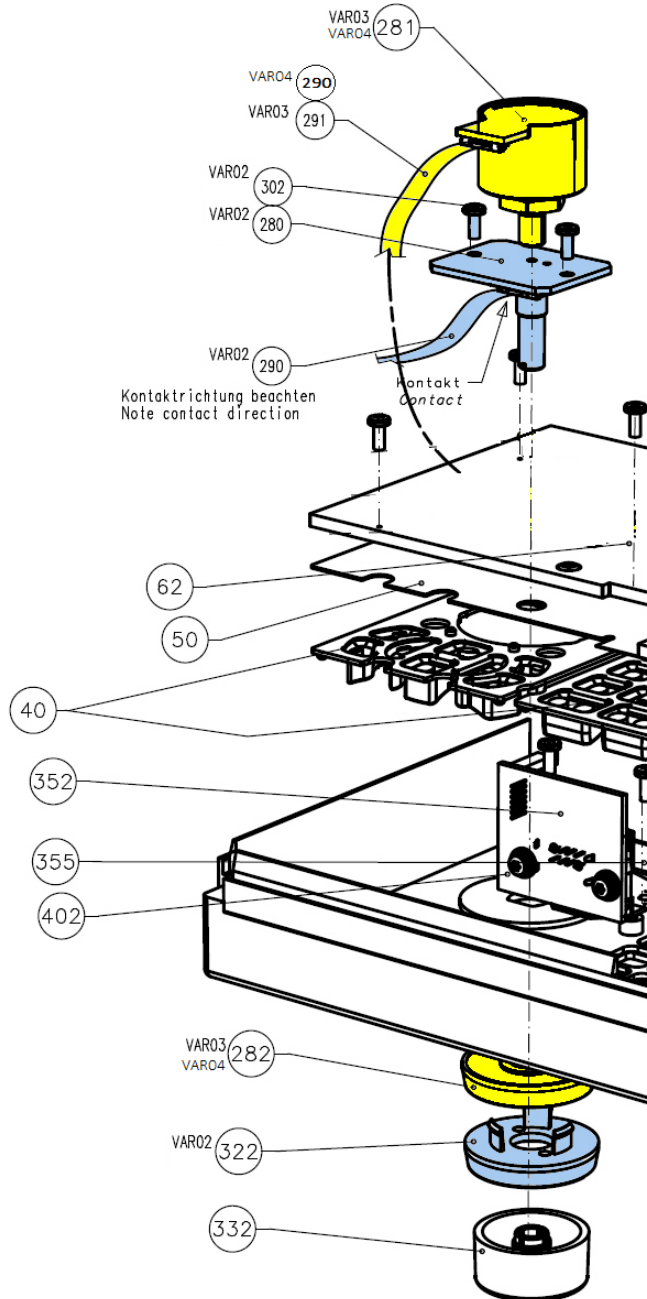

Different rotary pulse generator: Var.02 (blue), Var.03 and 04 (yellow).

The TFT display A710 (140) is clipped in the display frame, which nestles in the R&S SMBV front cover (22). The screened filter glass (102), the flex. switchboard A320 (50) and the pushbutton board set (40) also lie in the R&S SMBV front cover (22). These three parts are affixed to the keyboard + LCD panel (65) on the R&S SMBV front cover (22). To replace, proceed as follows:

Removing the TFT Display, Flex. Switchboard and Pushbutton Board Set, Screened Filter Glass, Encoder Board, USB 2.0 Hub Board

Figures show only Var. 02, differences at Var. 03 / 04 (see page 3.63).

- Switch off the instrument and pull the mains plug.
- Dismount the cabinet (see page 3.55).
- Remove the front unit A700 (see page 3.57).
- Remove the rotary knob (332) from the front of the R&S SMBV front cover (22).

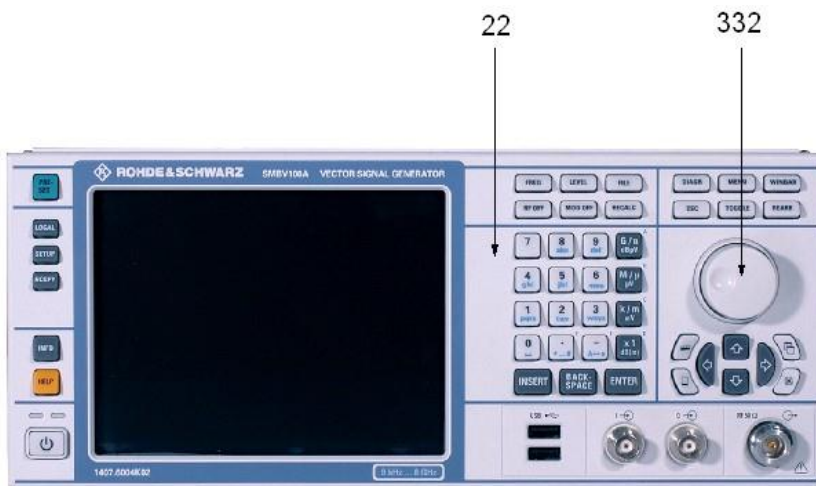

- Unscrew the two die-cast screws (302) and remove the encoder board A310 (280).

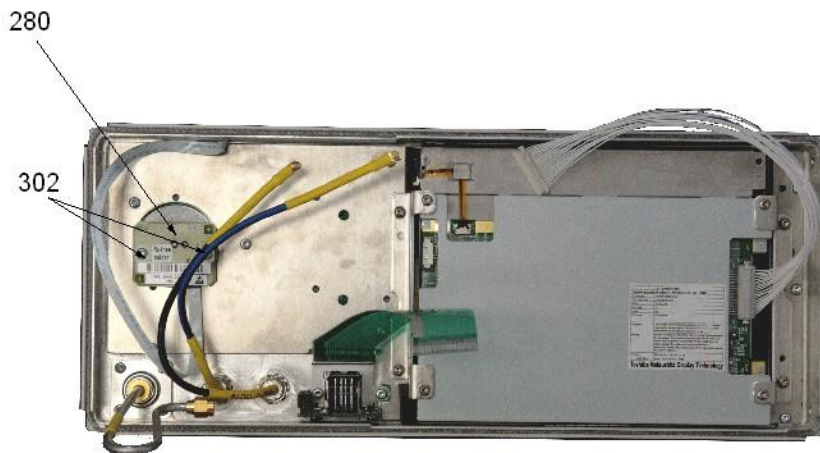

- Unscrew the two screw-and-washer assemblies (402) and remove the USB 2.0 hub board A720 (352).

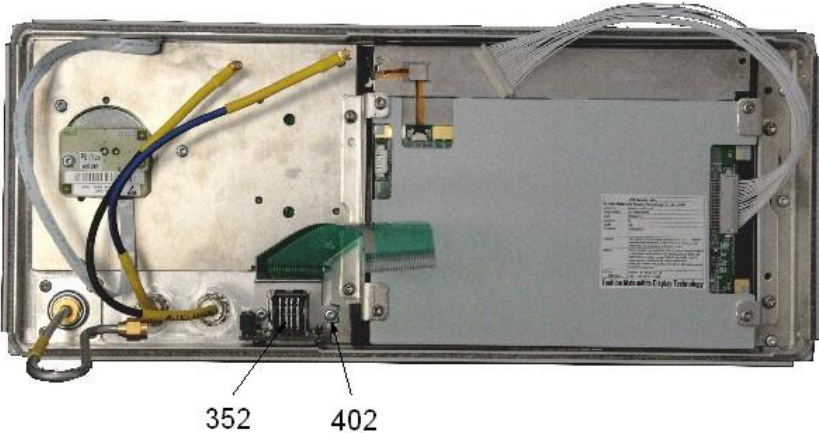

- Unscrew the four screw-and-washer assemblies (152) and remove the VGA LVDS display A710 (140).

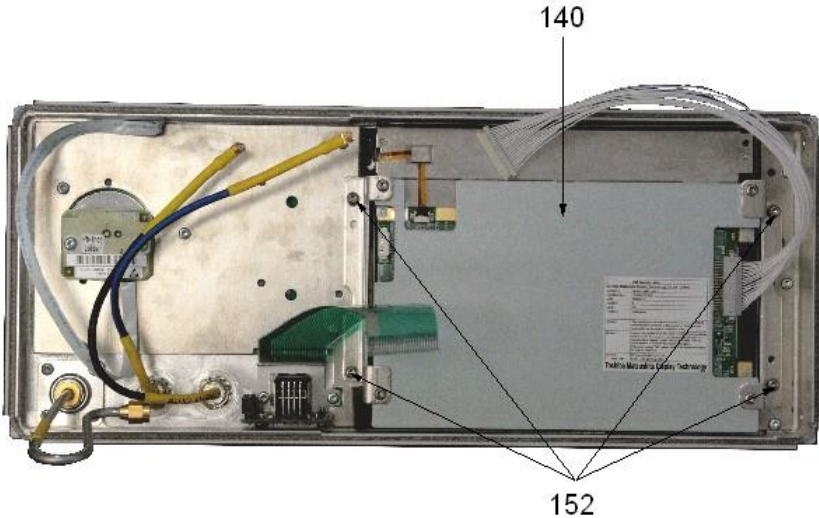

- Unscrew the four screws (162) and remove the LCD panel (130) from the VGA LVDS display A710 (140).

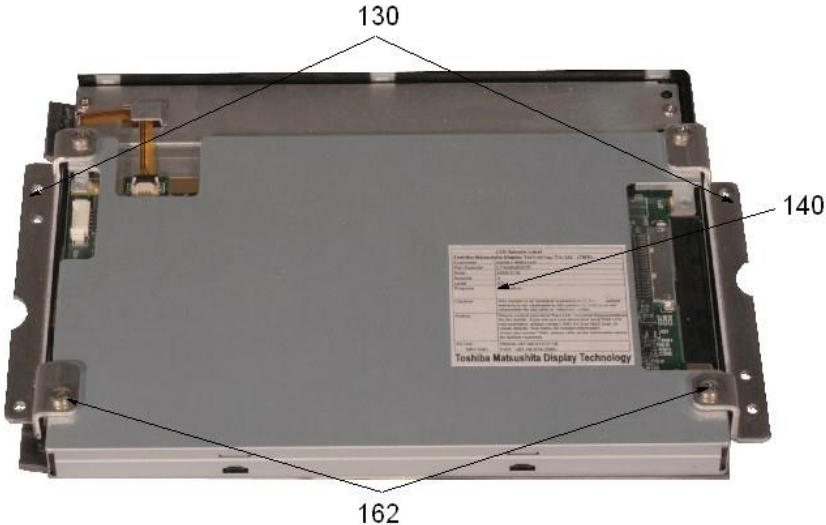

- Unscrew the eight die-cast screws (72) and remove the keyboard + LCD panel (65).

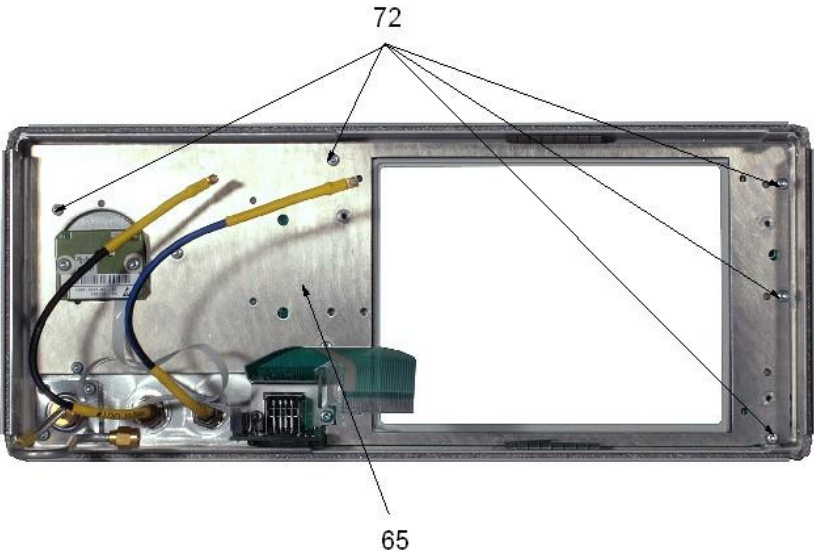

- Remove the flex. switchboard A320 (50), the pushbutton board set (40) and the screened filter glass (105).

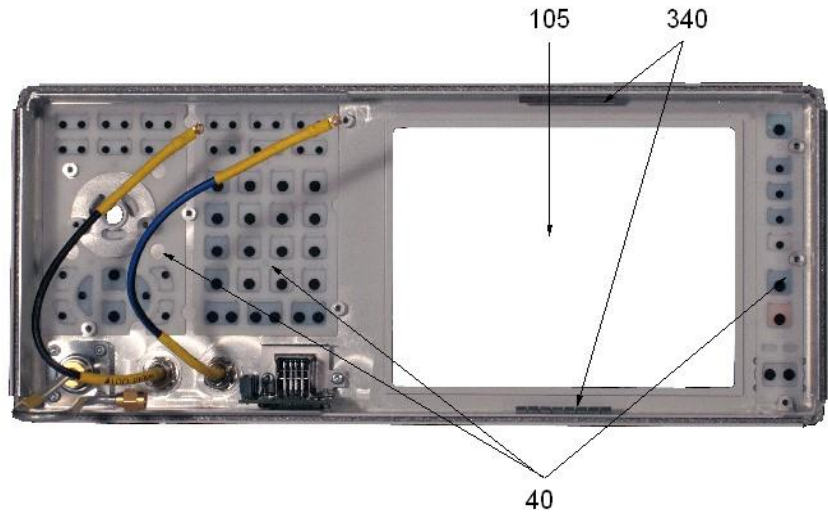
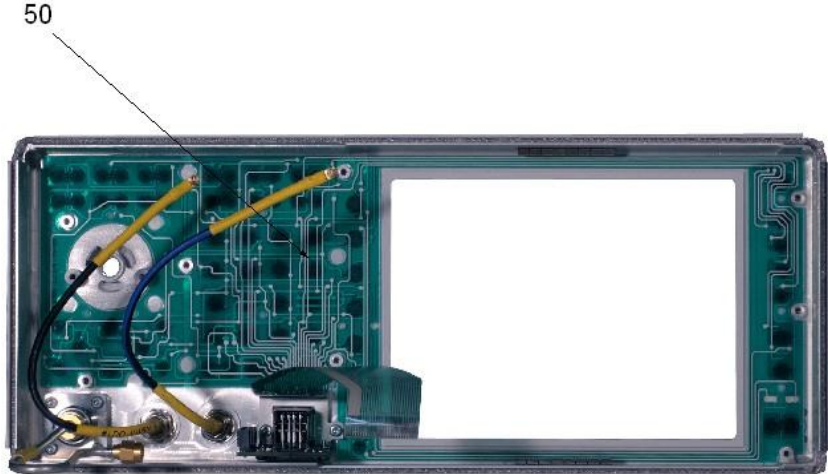

Installing the TFT Display, Flex. Switchboard and Pushbutton Board Set, Screened Filter Glass, Encoder Board and the USB 2.0 Hub Board

- Attach the screened filter glass (105), pushbutton board set (40) and the flex. switchboard (50).

NOTICE**Use clean parts**

Make sure that the installed screened filter glass is free of dust and fingerprints.

Figures show only Var. 02, differences at Var. 03 / 04 (see page 3.63).

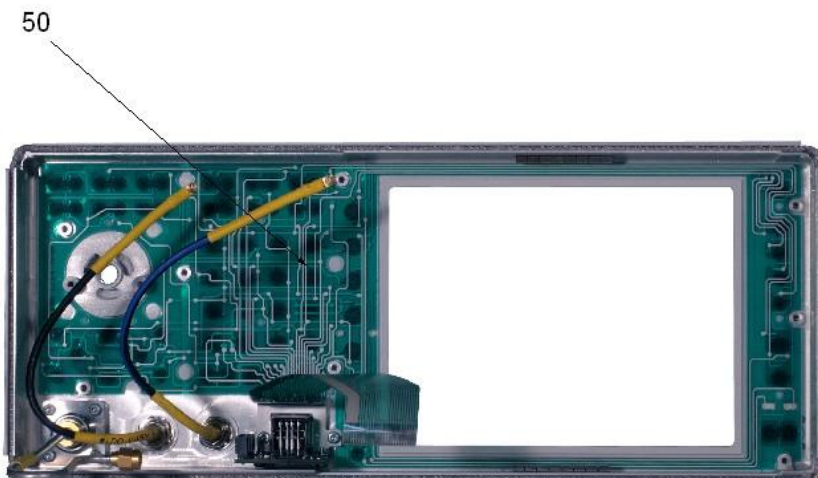
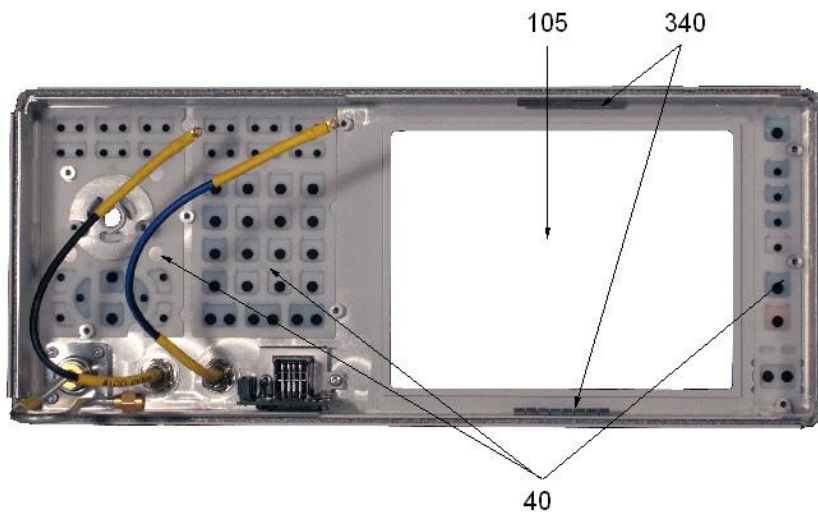

- Attach the keyboard + LCD panel (65) and fasten it with the eight die-cast screws (72).

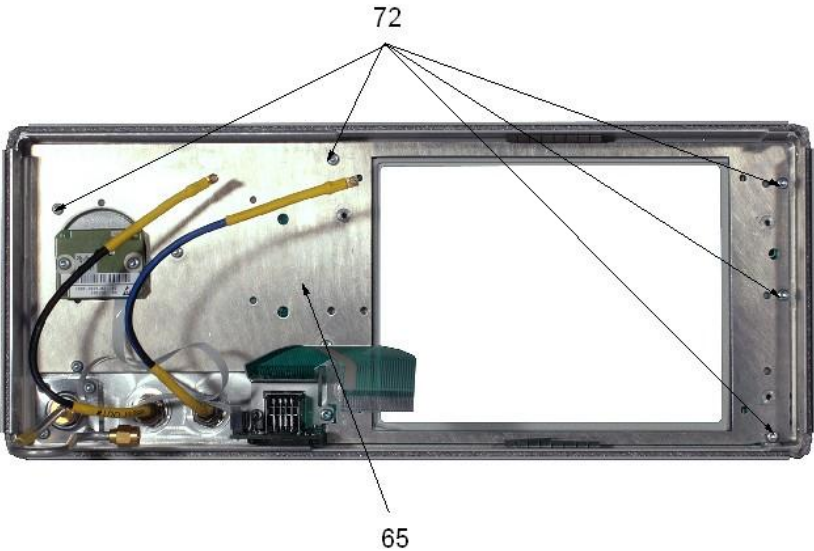

- Attach the LCD panel (130) on the VGA LVDS display (140) and fasten it with the four screws (162).

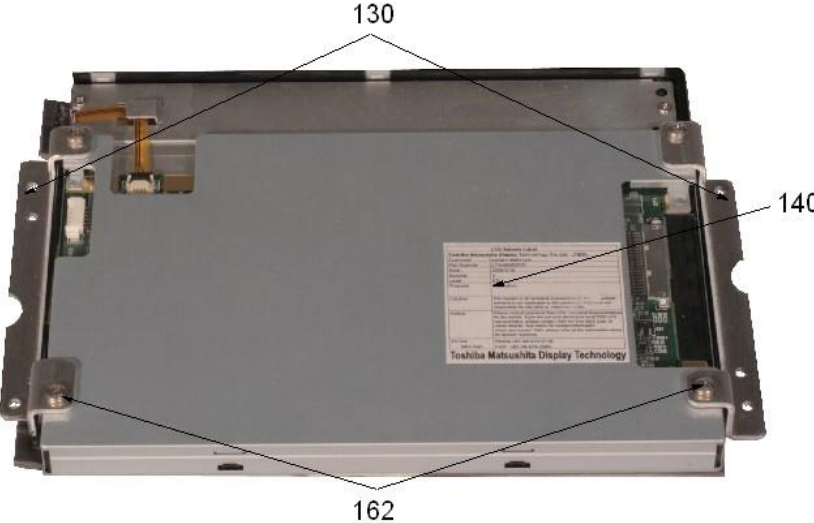

- Remove the VGA LVDS display (140) and fasten it with the four screw-and-washer assemblies (152).

NOTICE**Use clean parts**

Make sure that the installed LVDS display is free of dust and fingerprints.

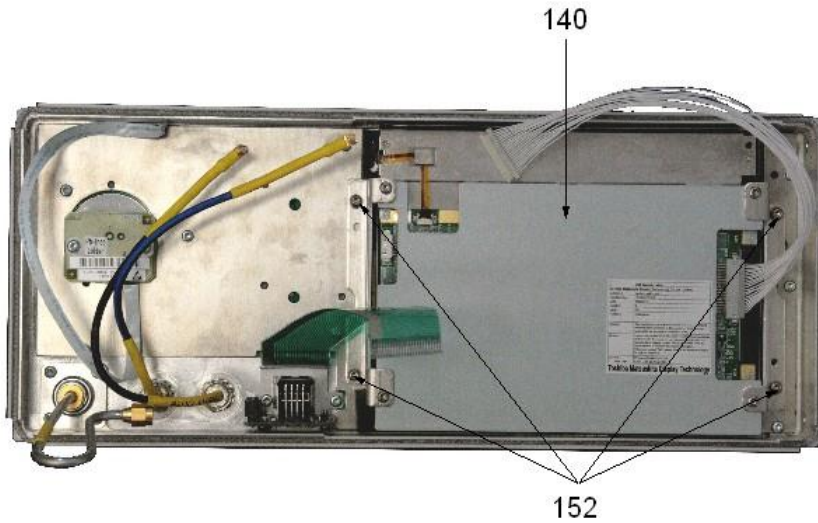

- Screw-fasten the encoder board A310 (280) with the two die-cast screws (302).

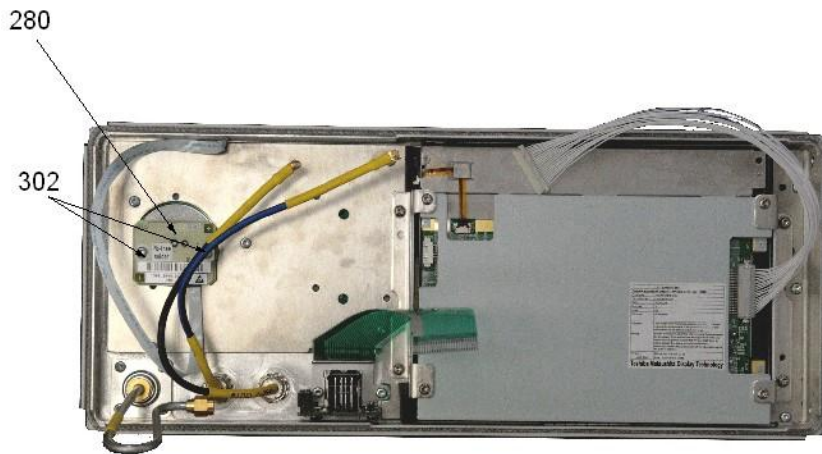

- Screw-fasten the USB 2.0 hub board A720 (352) with the two screw-and-washer assemblies (402).

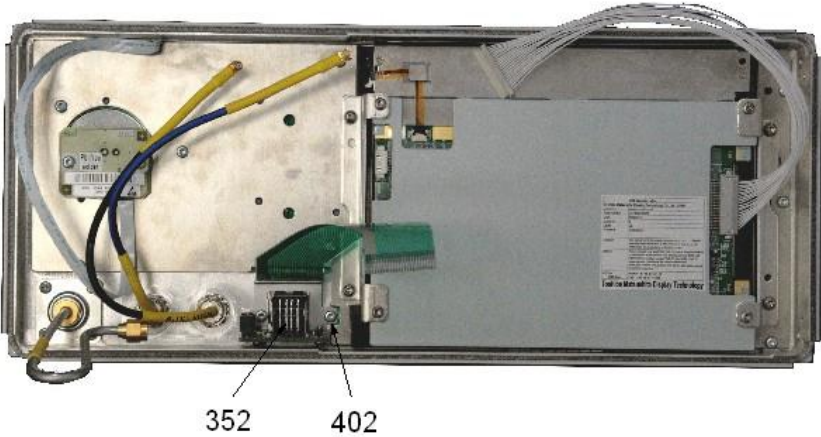

- Mount the rotary knob (332) to the front of the front cover R&S SMBV (22).

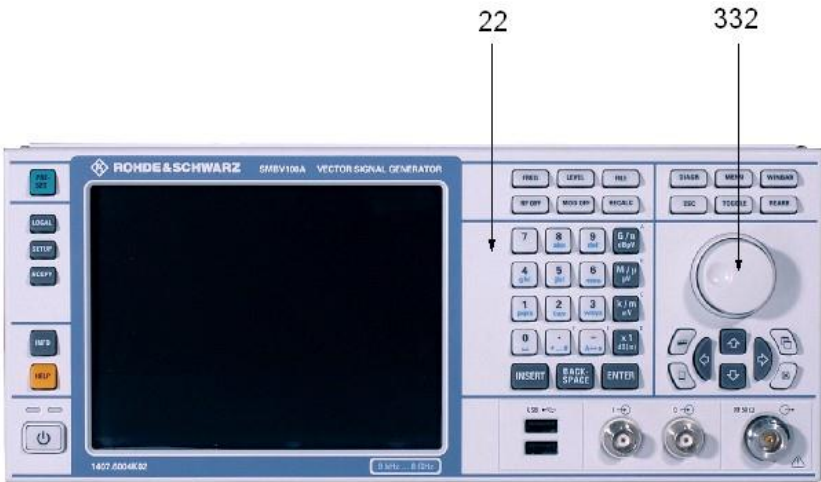

- Attach the front unit A700 (see page 3.60).
- Mount the cabinet (see page 3.55).

Replacing the R&S SMBV-B92 Hard Disc

(see chapter 5, drawings and parts lists 1407.6004.01 / 1407.9403.01).

Removing the R&S SMBV-B92 Hard Disc

- Switch off the instrument and pull the mains plugs.
- Unscrew the two knurled-head screws.
- Carefully remove the hard disc.

Installing the R&S SMBV-B92 Hard Disc

- Carefully insert in the hard disc as far as possible.

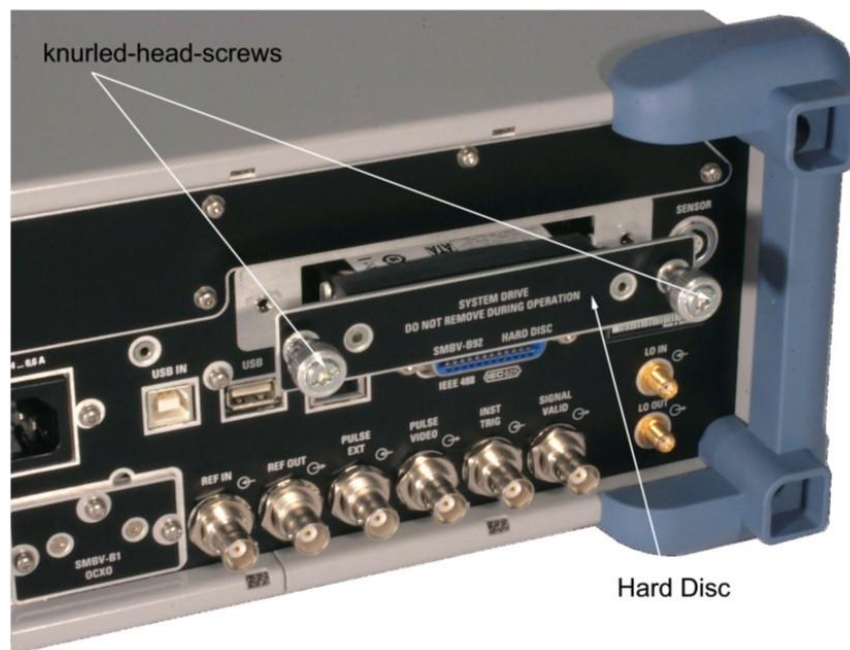

- Fasten the hard disc with the two knurled-head screws.

Replacing the R&S SMBV-B90 Phase Coherence

(See chapter 5, drawings and parts lists 1407.6004.01 / 1407.9303.01)

Removing the R&S SMBV-B90 Phase Coherence

- Switch off the instrument and pull the mains plugs.
- Disconnect the two RF cables W503 (1520) and W504 (1530) on the vector board A500 (450).

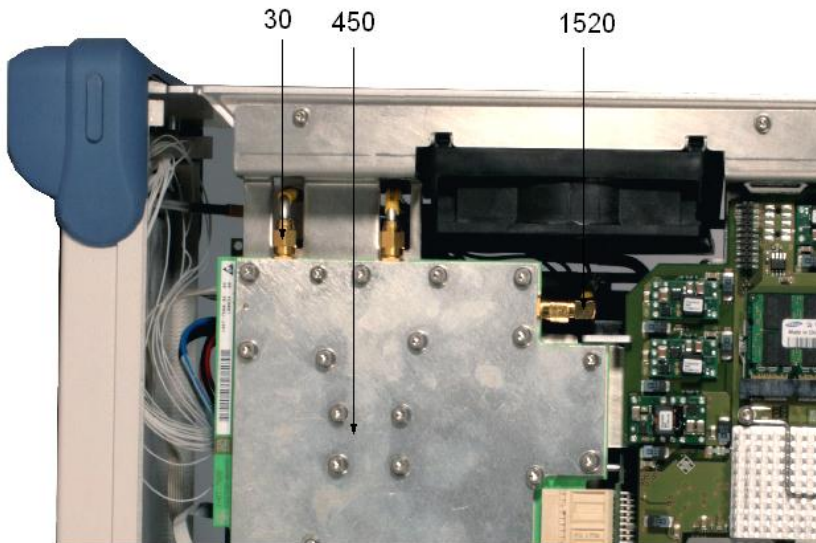

- Disconnect the two RF cables W503 (1520) and W504 (1530).
W503 (1520) LO IN
W504 (1530) LO OUT
- Connect the two covers (665) on the rear panel of the instrument (instead of the connectors at LO IN (1520) and LO OUT (1530)).



- Mount the cabinet (see page 3.55).

Installing the R&S SMBV-B90 Phase Coherence

- Switch off the instrument and pull the mains plugs.
- Dismount the cabinet (see page 3.55).
- Detach the two covers (665) from the rear panel of the instrument (instead of the connectors at position LO IN (1520) and LO OUT (1530)).



- Mount the two RF cables W503 (1520) and W504 (1530) at the place from the two covers.
 W503 (1520) LO IN
 W504 (1530) LO OUT

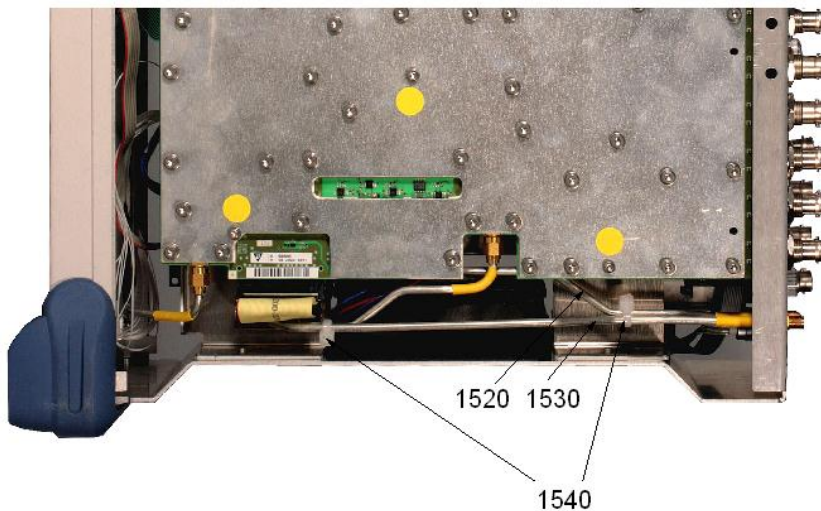

- Fix the two RF cables W503 (1520) and W504 (1530) with the two cable ties (1540).

- Connect the two RF cables W503 (1520) and W504 (1530) on the vector board A500 (450).

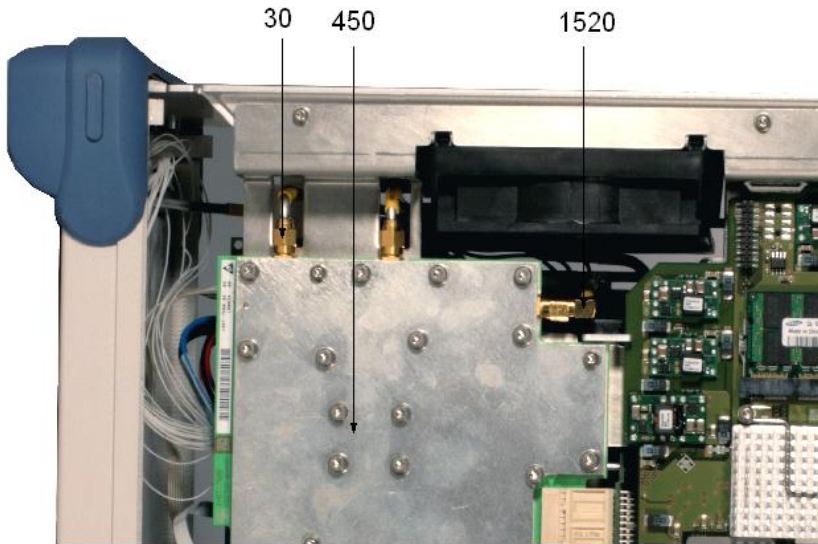

- Mount the cabinet (see page 3.55).

Replacing the R&S SMBV-B10/-B50/-B51 Baseband Generator

(See chapter 5, drawings and parts lists 1407.6004.01 / 1407.8607.01 / 1407.8907.01 / 1407.9003.01).

Removing the R&S SMBV-B10/-B50/-B51 Baseband Generator

- Switch off the instrument and pull the mains plugs.
- Unscrew the six screw-and-washer assemblies (620) from the rear panel of the R&S SMBV.
- Carefully pull the baseband generator A600 backwards and remove it.

Installing the R&S SMBV-B10/-B50/-B51 Baseband Generator

- Carefully plug in the baseband generator A600 (1120, 1220 or 1320) as far as possible.



- Connect the six screw-and-washer assemblies (620).

Replacing the Vector Board

(See chapter 5, drawing and parts list 1407.6004.01).

Removing the Vector Board

- Switch off the instrument and pull the mains plug.
- Dismount the cabinet (see page 3.55).

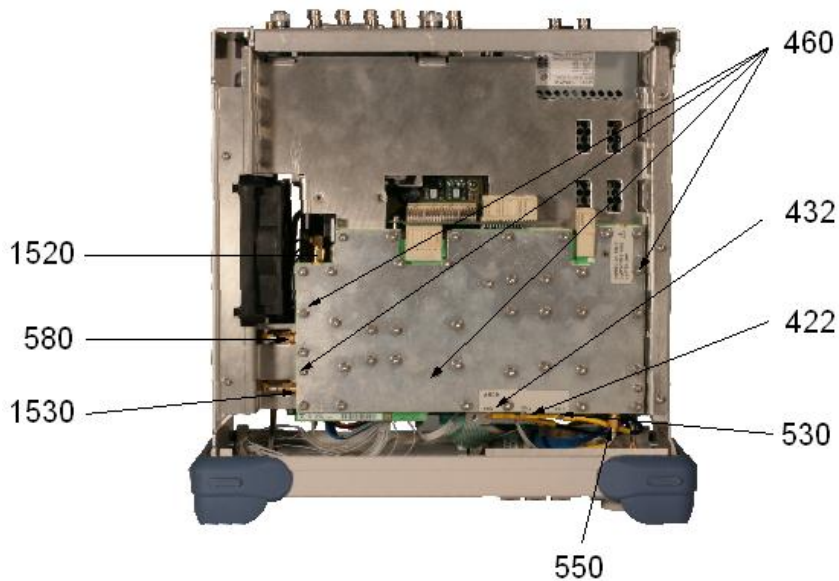

- Disconnect the RF cables W211 (550), W504 (1530), W216 (580) and W503 (1520).
- Disconnect the RF cables W502 (430), W501 (420) and W213 (530).
- Unscrew the five screws (460).
- Pull the vector board A500 forwards and remove it.

Installing the Vector Board

- Put the vector board A500 (450) into the R&S SMBV.
- Screw in the five screws (460).
- Connect the RF cables W211 (550), W504 (1530), W216 (580) and W503 (1520).
- Connect the RF cables W502 (432), W501 (422) and W213 (530).

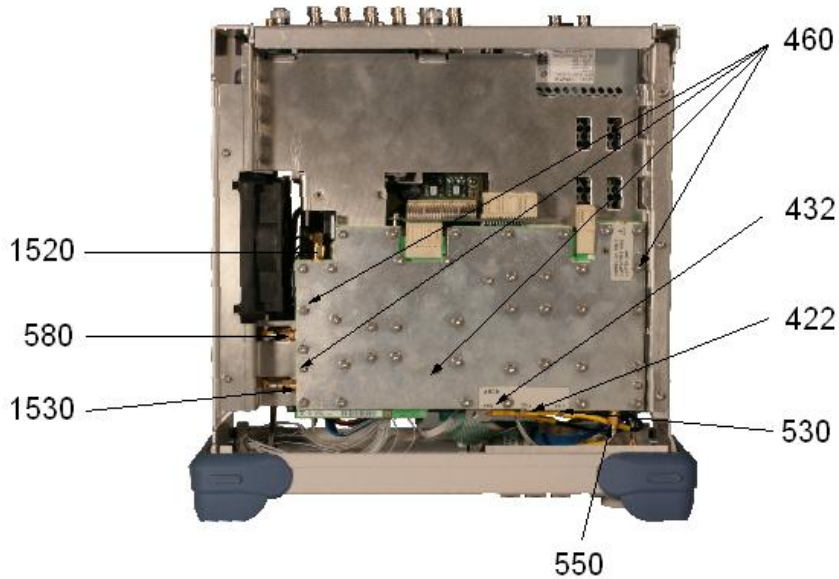

- Mount the cabinet (see page 3.55).

Replacing the Basis Board

(see chapter 5, drawing and parts list 1407.6004.01).

NOTICE The basis board variant depends on the front unit variant. For details see [Table 3-2](#) on page 3.52.

Removing the Basis Board

- Switch off the instrument and pull the mains plug.
- Dismount the cabinet (see page 3.55).
- If the R&S SMBV-B10/-B50/-B51 baseband generator A600 is included, first remove it (see page 3.77).
- If the R&S SMBV-B92 hard disc is included, remove it (see page 3.73).
- Remove the vector board A500 (see page 3.78).
- Disconnect the seven screw-and-washer assemblies (310).
- Remove the trough (300).

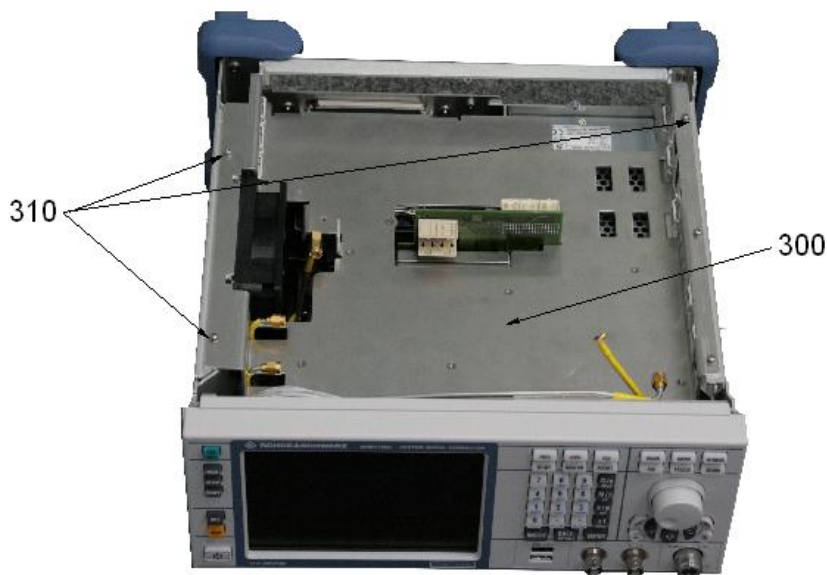

- Disconnect the SATA data cable W141 (420) and the SATA power cable W142 (430).

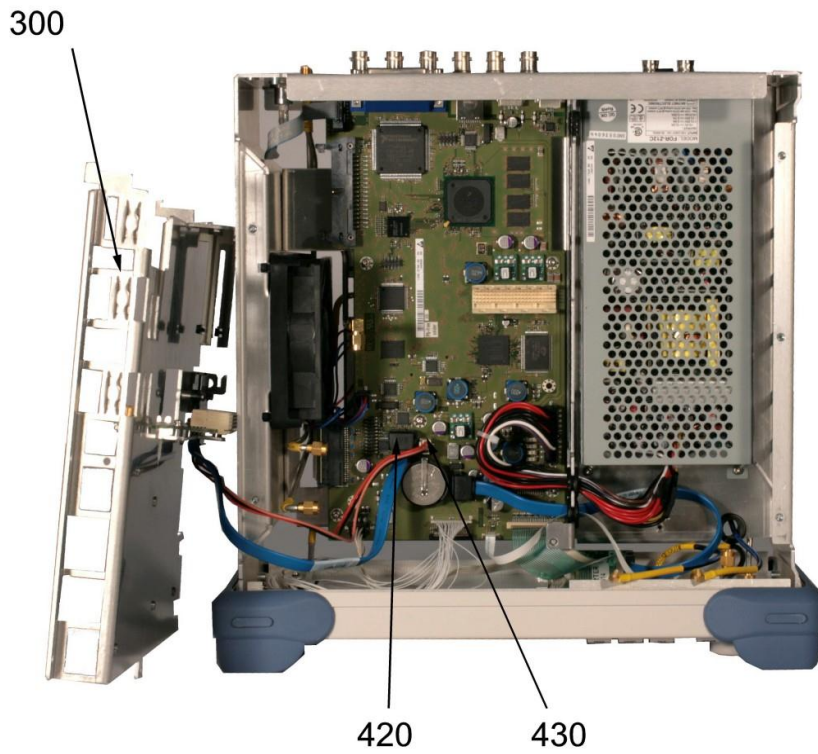

- Disconnect the fan cable from X116 and the power supply cable from X101 (remove the plastic tie before disconnecting the cable).

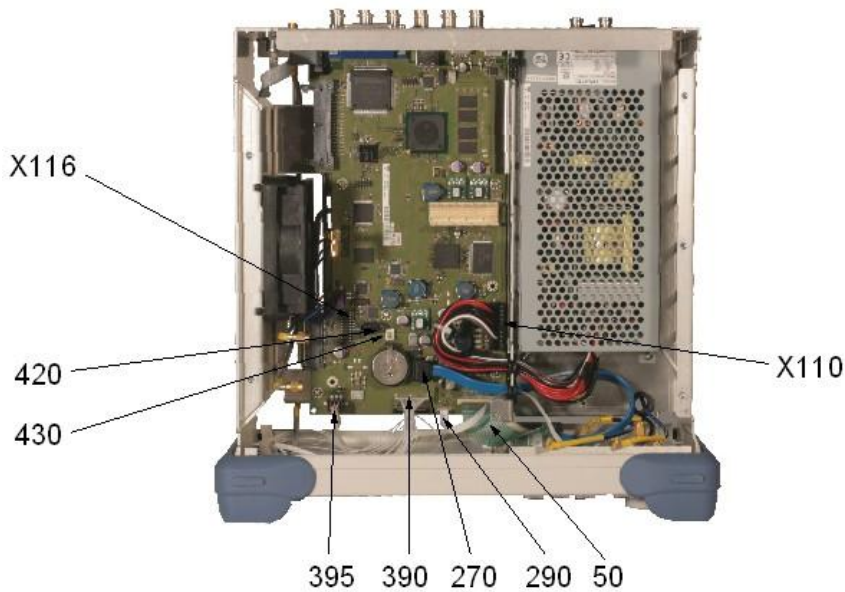

- Disconnect the SATA data cable W115 (270), the LCD LED input cable W114 (395), the flex strip 10-pin cable W111 (290), Toshiba display cable W113 (390) and the flex. switchboard cable A320 (50).

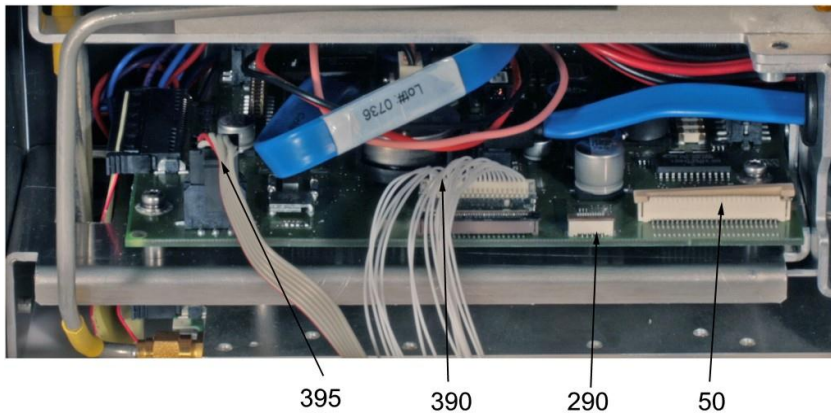

- Unscrew one screw-and-washer assembly (110) and two screws from the IEC connector at the back of the instrument.

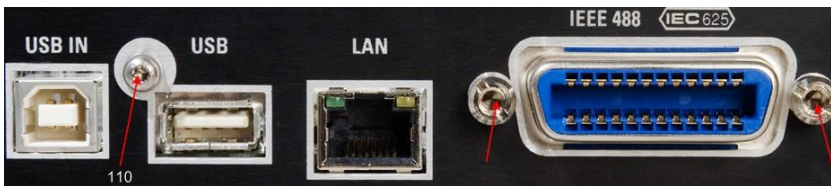

- Unscrew the six screw-and-washer assemblies (110) from the Basis Board A100 (100).
- Remove the Basis Board A100 (100) by turning it up towards the front and pulling it out and upward.

NOTICE

When changing the Basis Board, you have to remove the SIM card. The SIM card is part of your instrument and will not be replaced by Rohde & Schwarz if lost. Therefore, always keep the SIM card with you.



Installing the Basis Board

- Place the screw angle on the IEC connector.
- Insert the new Basis Board A100 (100) and screw-fasten it with the six screw-and-washer assemblies (110).

NOTICE

When replacing the Basis Board, you have to move the SIM card from the old board to the new one. The SIM card is part of your instrument and will not be replaced by Rohde & Schwarz if lost!



- Screw in one screw-and-washer assembly (110) and two screws of the IEC connector at the back of the instrument.



- Connect the SATA data cable W115 (270), the LCD LED input cable W114 (395), the flex strip 10-pin cable W111 (290), Toshiba display cable W113 (390) and the flex. switchboard cable A320 (50).

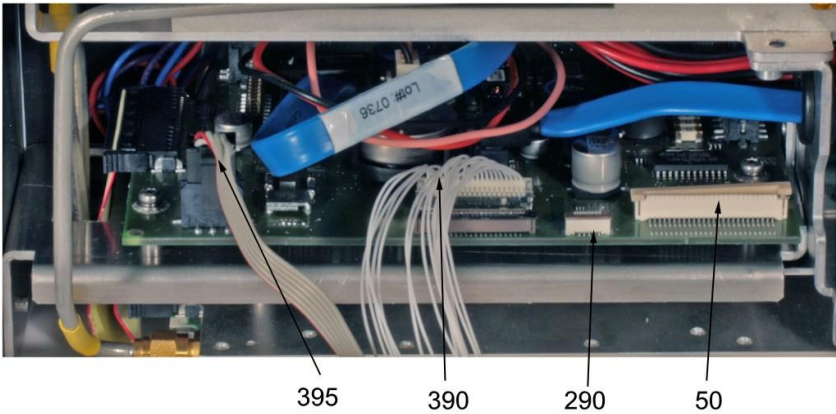

- Connect the SATA data cable W141 (420) and the SATA power cable W142 (430).
- Connect the fan cable from X116 and the power supply cable from X101.

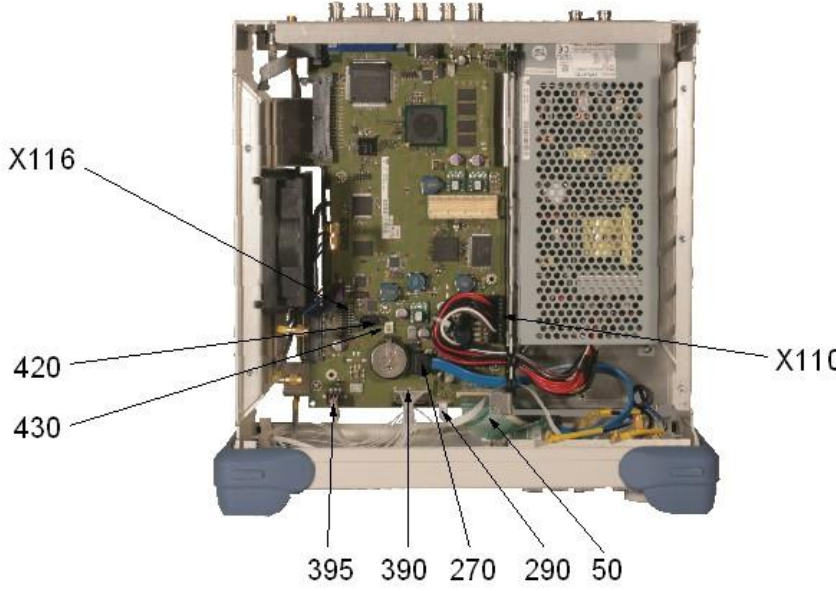

- Replace the trough (300) and screw-fasten it with the seven screw-and-washer assemblies (310).

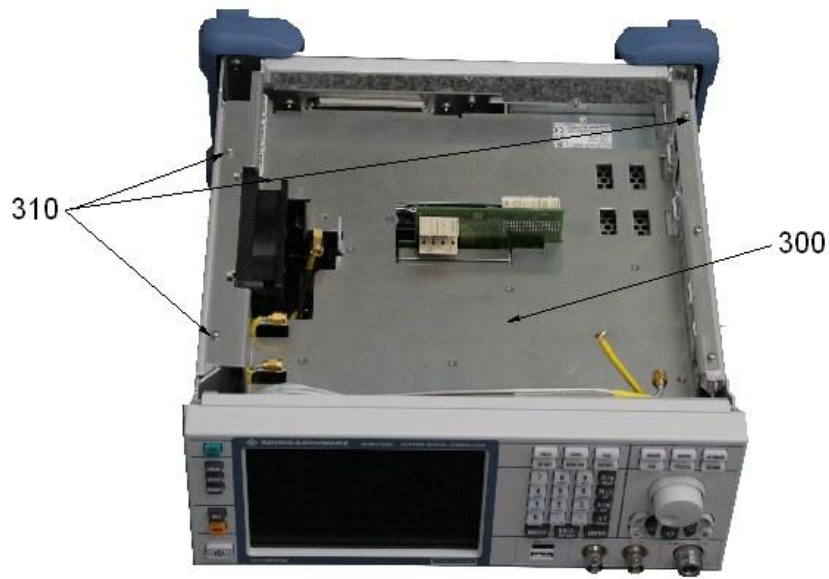

- Replace the vector board (see page 3.78)
- If the R&S SMBV-B10/-B50/-B51 option is included, remove it (see page 3.77).
- If the R&S SMBV-B92 option is included, remove it (see page 3.74).
- Mount the cabinet (see page 3.55).

Replacing the SIM Card

NOTICE When changing the Basis Board, you have to remove the SIM card.

The SIM card is part of your instrument and will not be replaced by Rohde & Schwarz if lost. Therefore, always keep the SIM card with you.

- Remove the Basis Board (see page 3.80).
The SIM card is located on the rear side of the Basis Board.

Sim card

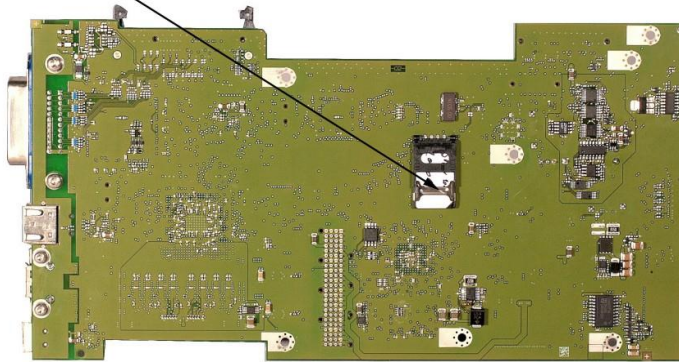

Different Position on Basis Board 4 (see page 3.7)

- Open the latch of the SIM card holder by sliding the retaining bracket toward OPEN.

The latch of the SIM card holder is open.

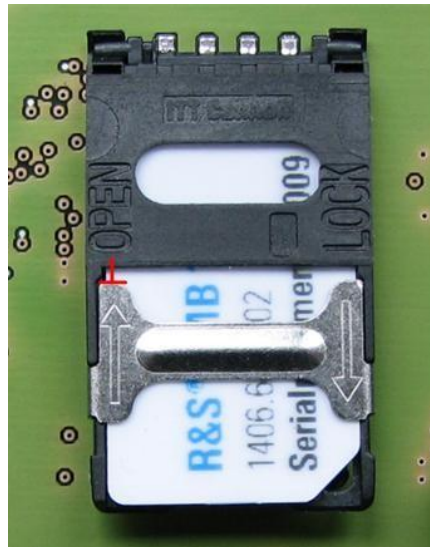
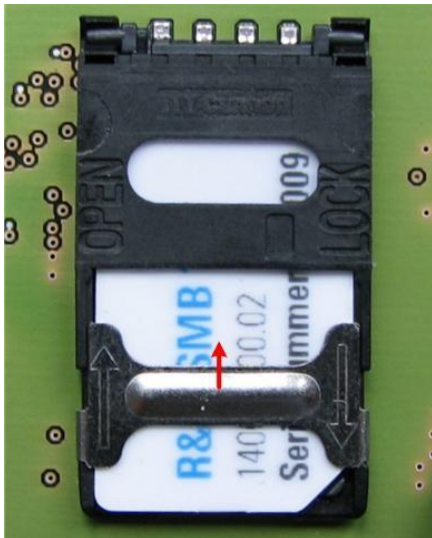

- Flip the SIM card holder upward and remove the SIM card.

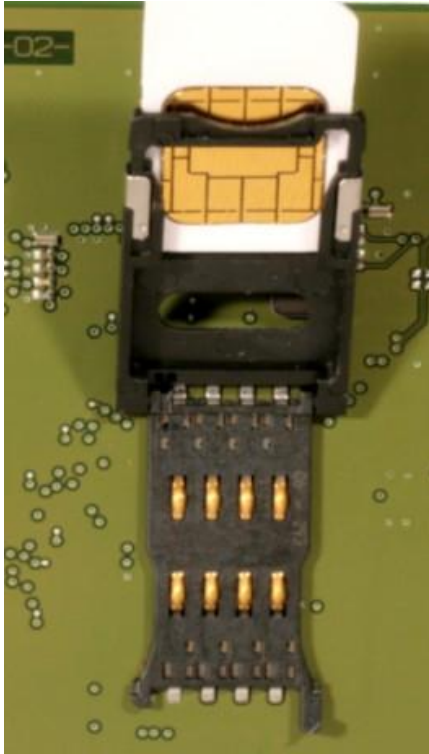

- To install the SIM card, proceed in the reverse order.

Replacing the RF Board

(see chapter 5, drawing and parts list 1407.6004.01).

Removing the RF Board

Note:

If the R&S SMBV-B1/-B1H (reference oscillator) option is installed, uninstall this option first (see page 3.102)

- Switch off the instrument and pull the mains plug.
- Dismount the cabinet (see page 3.55).
- Disconnect the RF cables W213 (530), W214 (510), W215 (520), W211 (550), W212V (250) W216 (580) and the BB-RF board W222 cable (540).

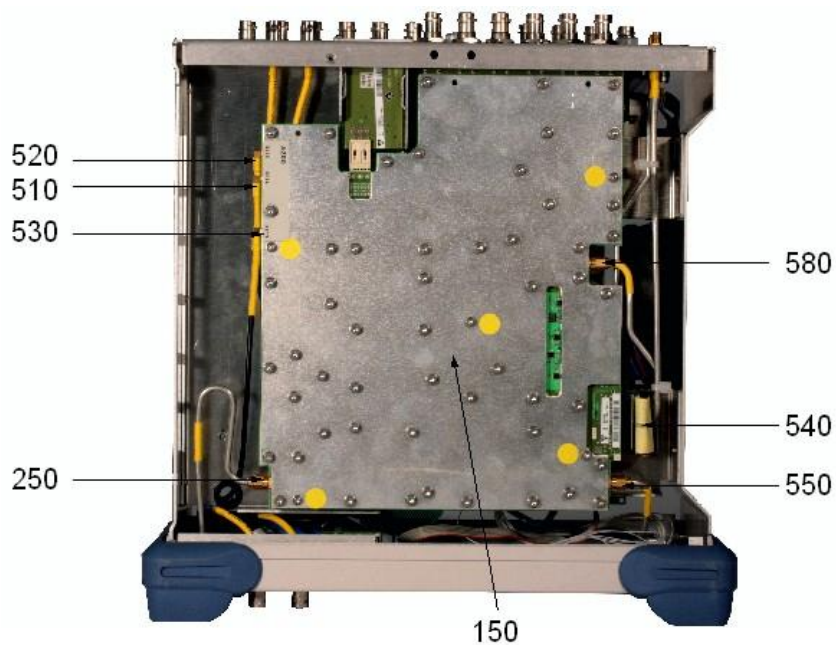

- Remove the six nuts (154) of the BNC connectors.
- Unscrew the eight screws (160) on the RF board A200 (150) and remove the board.

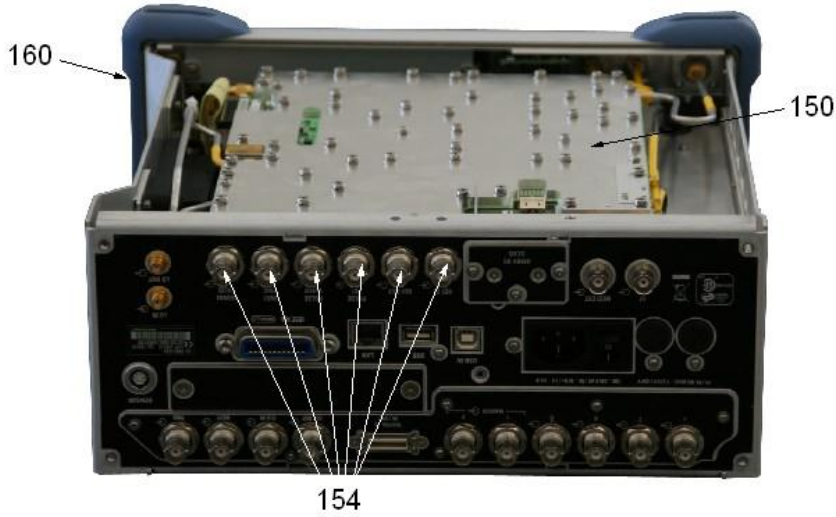

Installing the RF Board

- Place the RF board A200 (150) into the R&S SMBV frame in the right position and screw-fasten it with eight screws (160).
- Screw-fasten the six BNC connectors with the nuts (154).

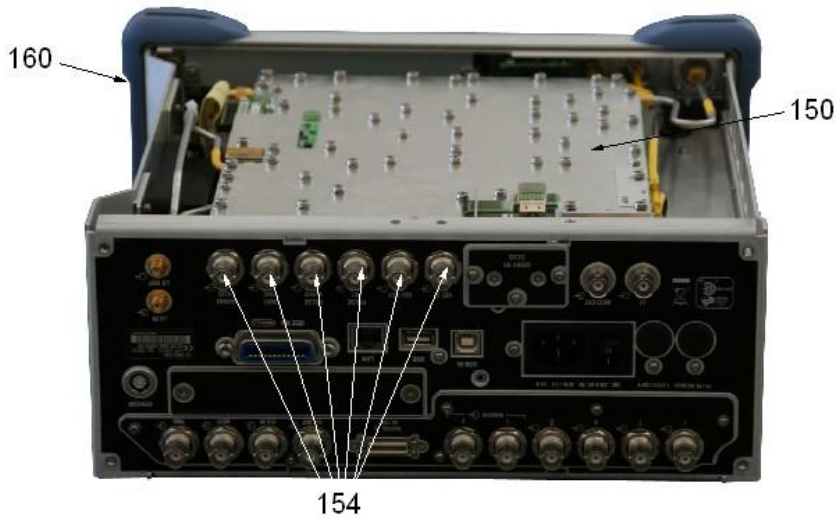

- Connect the RF cables W213 (530), W214 (510), W215 (520), W211 (550), W212V (250) W216 (580) and the BB-RF board W222 cable (540).

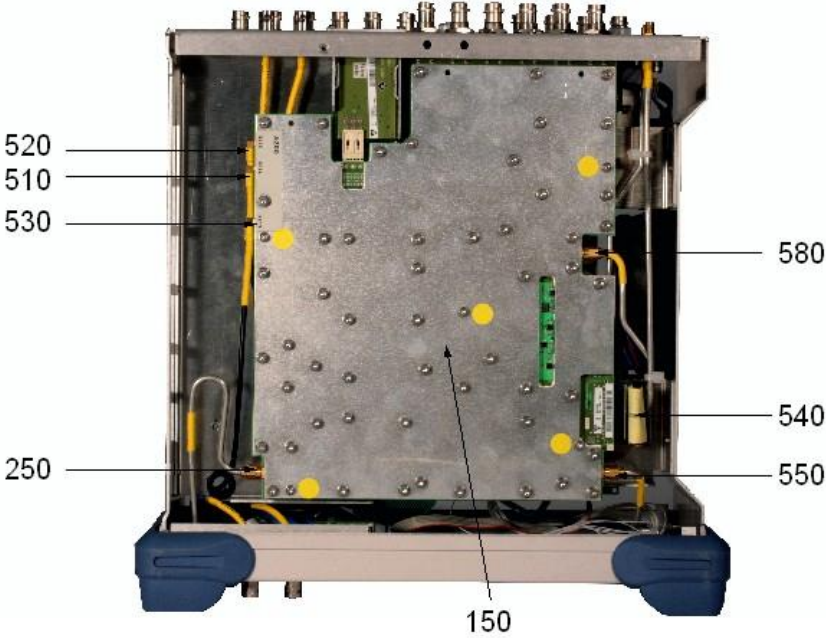

- Mount the cabinet (see page 3.55)

Replacing the Power Supply

(see chapter 5, drawing and parts list 1407.6004.01).

Removing the Power Supply

- Switch off the instrument and pull the mains plug.
- Dismount the cabinet (see page 3.55).
- If the R&S SMBV-B10/-B50/-B51 baseband generator A600 is included, first remove it (see page 3.77).
- If the R&S SMBV-B92 hard disc is included, remove it (see page 3.73).
- Remove the vector board A500 (see page 3.78).
- Unscrew the six screw-and-washer assemblies (310).

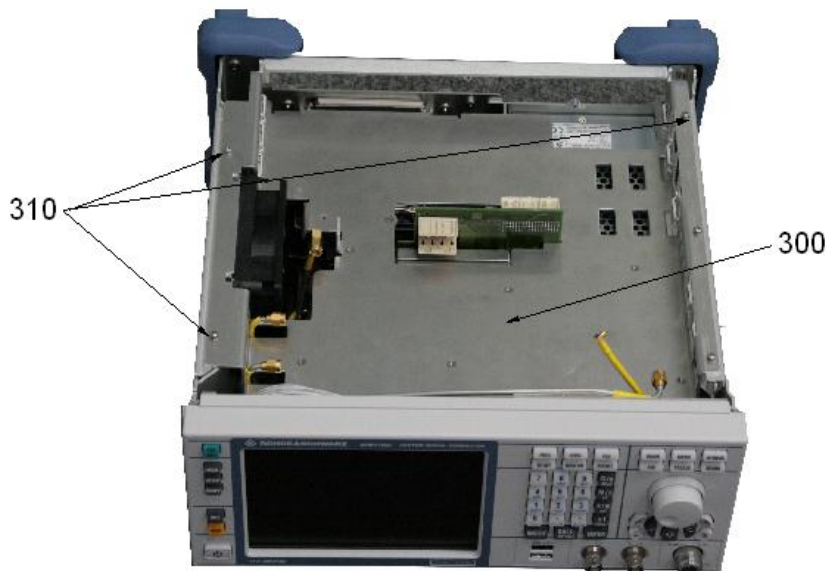

- Remove the trough (300).

- Remove connector X101 from the Basis Board A100 (100).
- Unscrew two screw-and-washer assemblies (70).

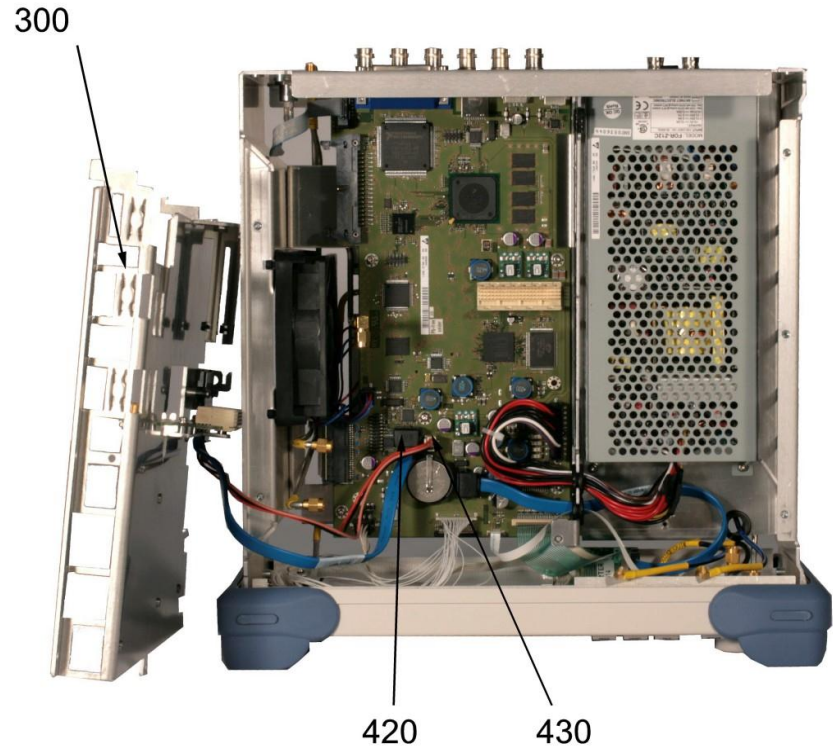

- Unscrew three screw-and-washer assemblies (70) at the rear panel of the instrument.



- Pull the power supply A50 (60) forward and remove it.

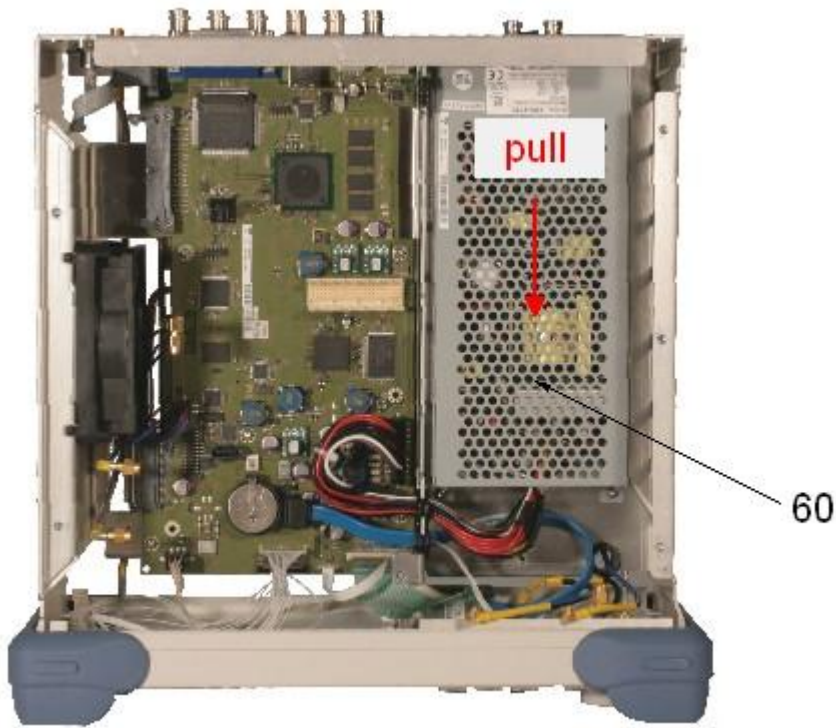

Installing the Power Supply

- Place the power supply A50 (60) in the instrument and screw-fasten it with two screw-and-washer assemblies (70) at the power supply trough.

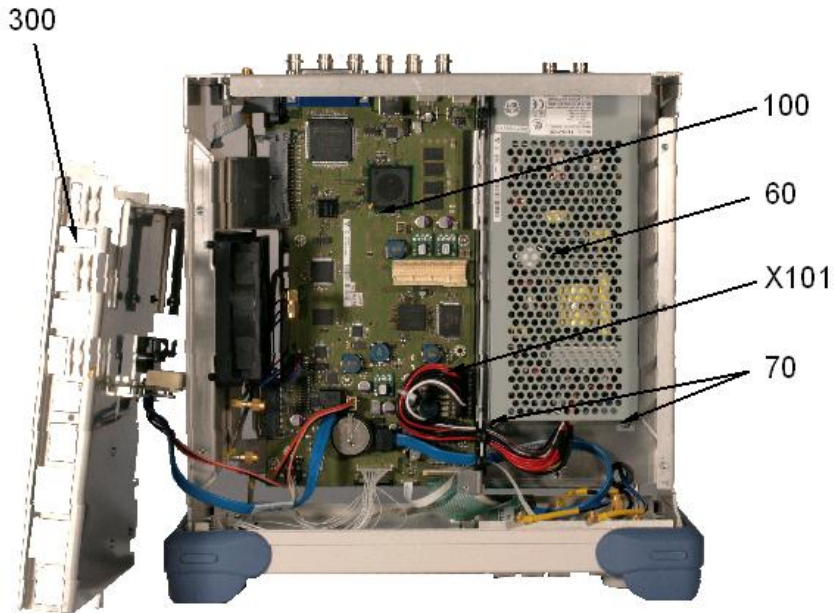

- Connect the power supply cable at X101 on the Basis Board.
- Affix the power supply A50 (60) at the back of the instrument with three screw-and-washer assemblies (70).



- Replace the trough (300) and screw-fasten it with the six screw-and-washer assemblies (310).

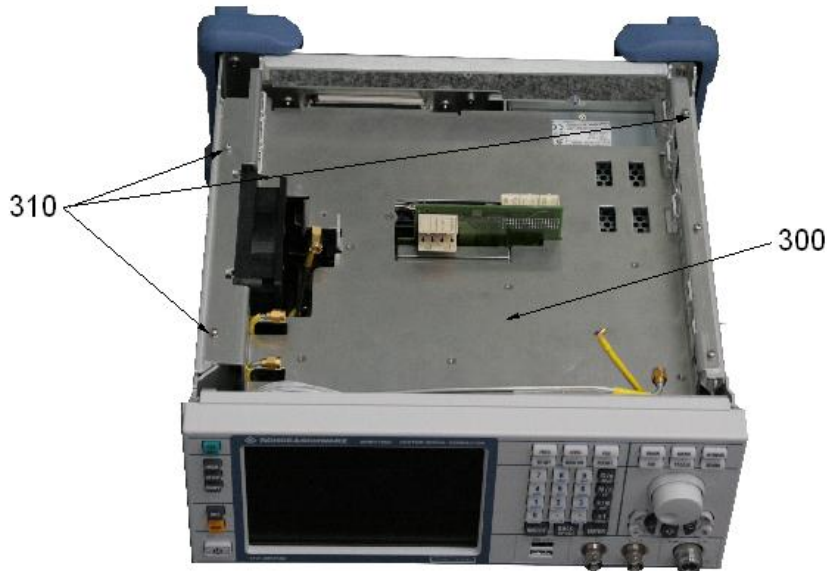

- Replace the vector board (see page 3.78).
- If the R&S SMBV-B10/-B50/-B51 option is included, replace it (see page 3.77).
- If the R&S SMBV-B92 option is included, replace it (see page 3.73).
- Mount the cabinet (see page 3.55).

Replacing the Fan Unit

(see chapter 5, drawing and parts list 1407.6004.01).

Removing the Fan Unit

- Switch off the instrument and pull the mains plug.
- Dismount the cabinet (see page 3.55).
- Press the fan unit E1 (142) out of the grill for fan (144).



- Pull the fan unit E1 (142) upwards.

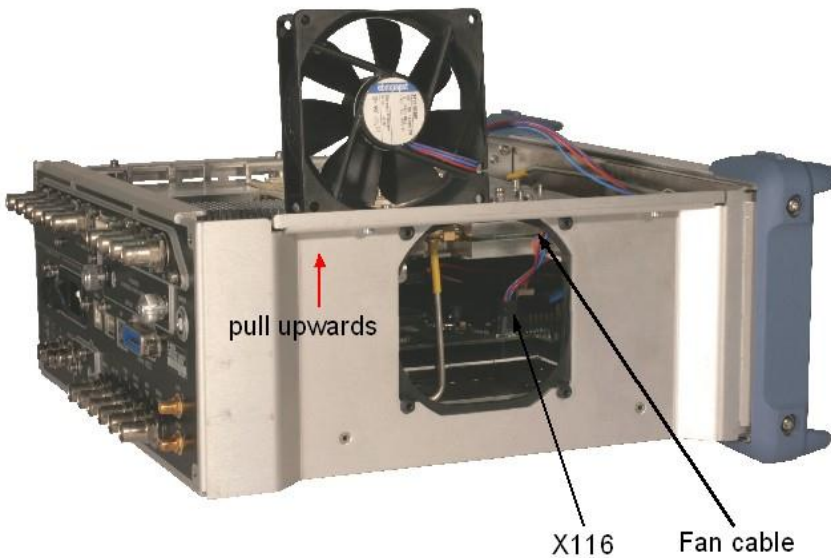

- Disconnect the fan cable at X116.

Installing the Fan Unit

- Install the new fan and connect the fan cable at X116.

NOTICE Note the fan direction of rotation (arrow on fan must point to the outside) air is sucked off the device.

- Press the fan unit E1 (142) into the grill for fan (144).

Replacing the Li Bridge

(See chapter 5, drawing 1407.6004.01 sheet 2).

Removing the Li Bridge

- Switch off the instrument and pull the mains plug.
- Dismount the cabinet (see page 3.55).
- If the R&S SMBV-B10/-B50/-B51 baseband generator A600 is included, first remove it (see page 3.77).
- If the R&S SMBV-B92 hard disc is included, remove it (see page 3.73).
- Remove the vector board A500 (see page 3.78).
- Unscrew the six screw-and-washer assemblies (310).

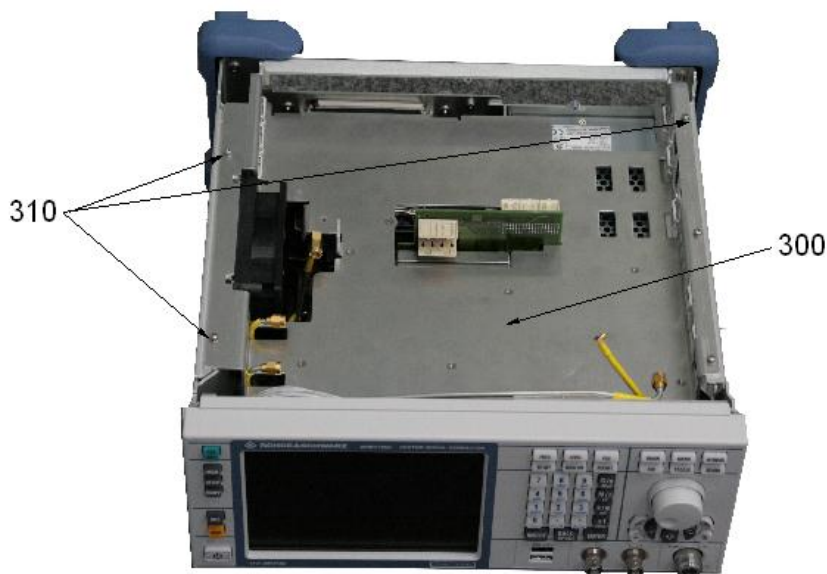

- Remove the trough (300).
- Disconnect the SATA data cable W141 (420) and the SATA power cable W142 (430).

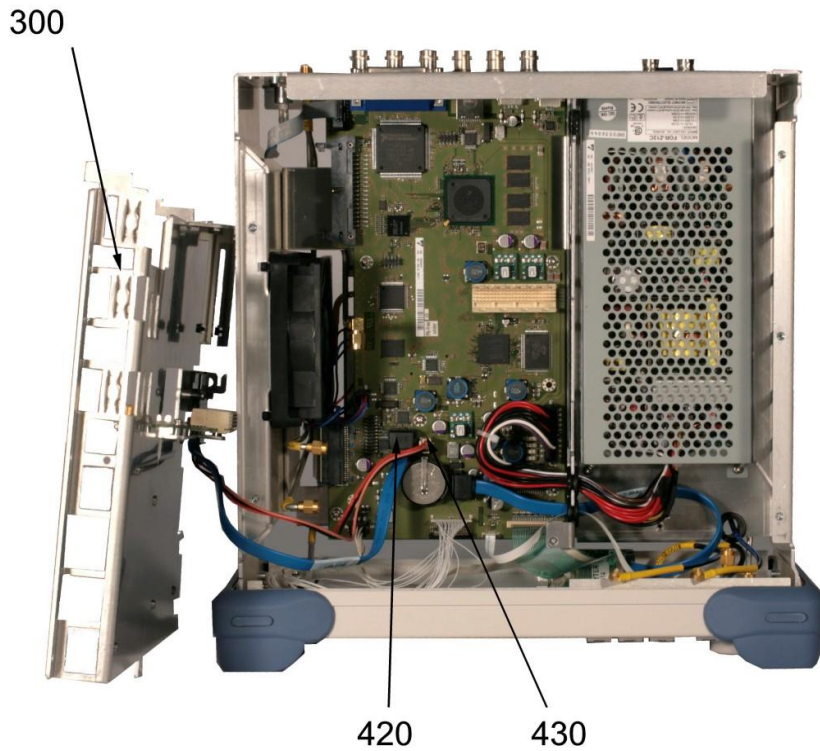

- Unscrew the three screw-and-washer assemblies (360) and remove the Li bridge A550 (350).

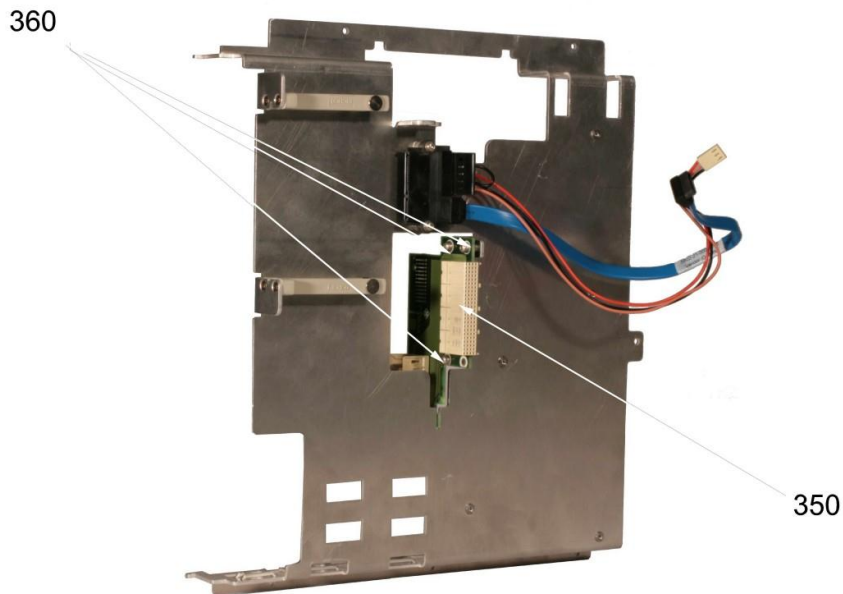

Installing the Li Bridge

- Attach the Li bridge A550 (350) and screw-fasten it with the three screw-and-washer assemblies (360).

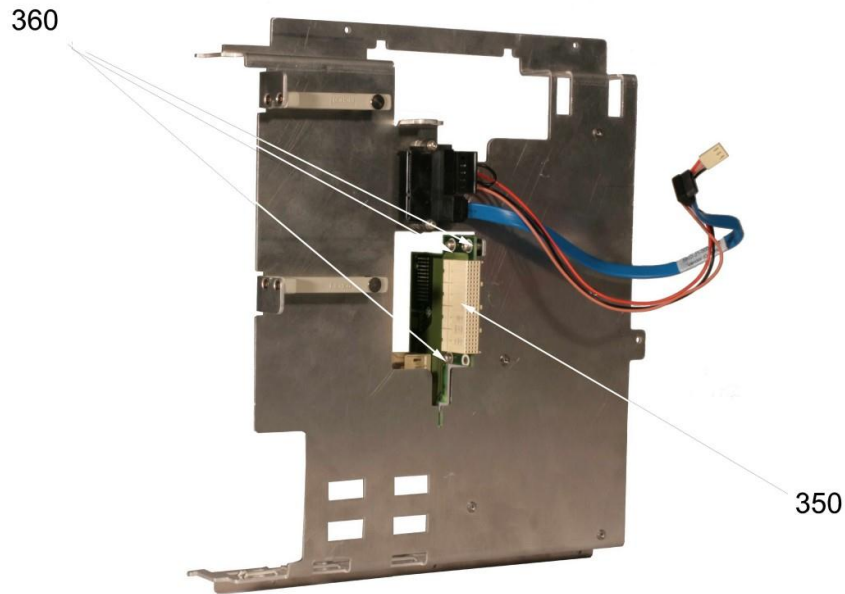

- Connect the SATA data cable W141 (420) and the SATA power cable W142 (430).

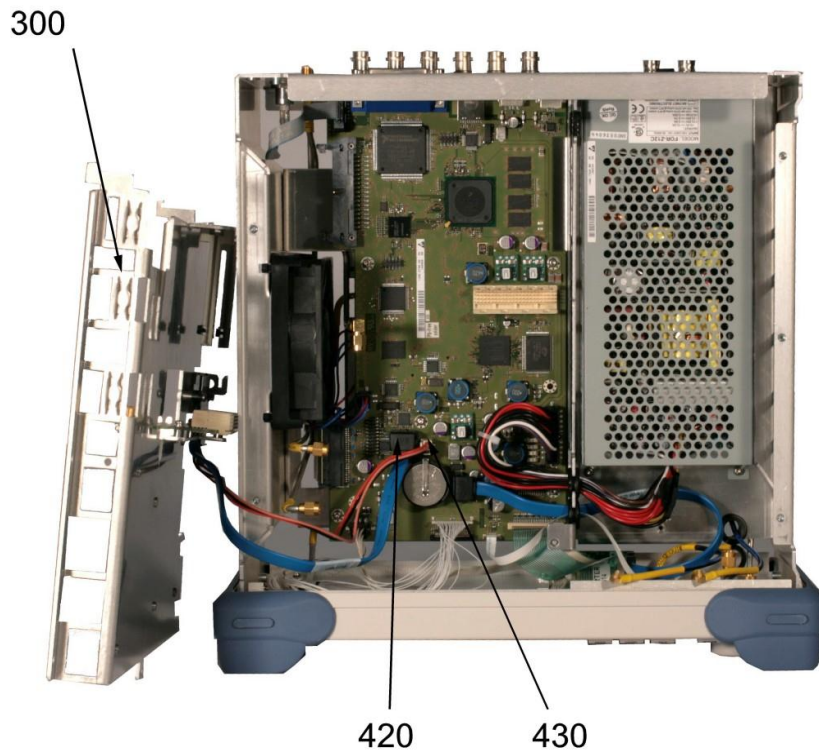

- Attach the trough (300) and screw-fasten it with the six screw-and-washer assemblies (310).

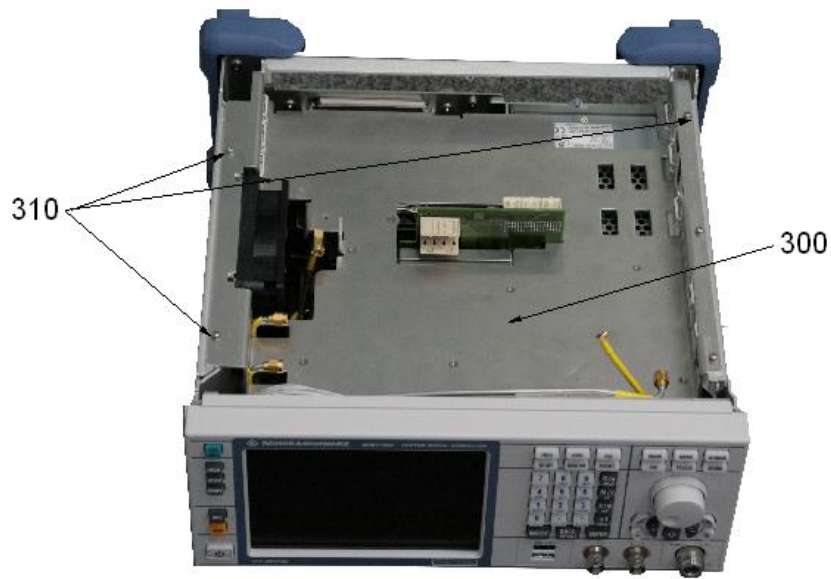

- Attach the vector board A500 (see page 3.79).
- If the R&S SMBV-B10/-B50/-B51 baseband generator A600 is included, mount it (see page 3.77).
- If the R&S SMBV-B92 hard disc is included, replace it (see page 3.73).
- Mount the cabinet (see page 3.55).

Replacing the Battery

The lithium battery is accommodated on the Basis Board.

- Switch off the instrument and pull the mains plug.
- Dismount the cabinet (see page 3.55).
- If the R&S SMBV-B10/-B50/-B51 baseband generator A600 is included, first remove it (see page 3.77).
- If the R&S SMBV-B92 hard disc is included, remove it (see page 3.73).
- Remove the vector board A500 (see page 3.78).
- Unscrew the six screw-and-washer assemblies (310).
- Remove the trough (300).

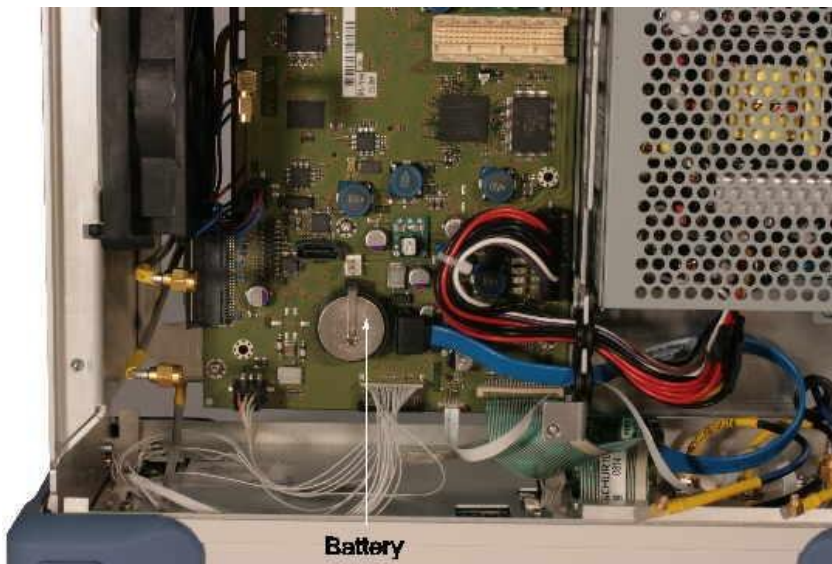

Different battery holder on Basis Board 4 (see page 3.7).

CAUTION



Handling of lithium batteries!

Lithium batteries must not be exposed to high temperature or fire. Keep away from children.

The battery may explode if replaced improperly. In particular, do not short-circuit the battery. Use batteries of the type recommended by Rohde & Schwarz only (see also ["Overview of the Modules"](#), page 3.51).

Lithium batteries are hazardous waste and must be disposed of in dedicated containers.

- Carefully lift and pull out the battery.

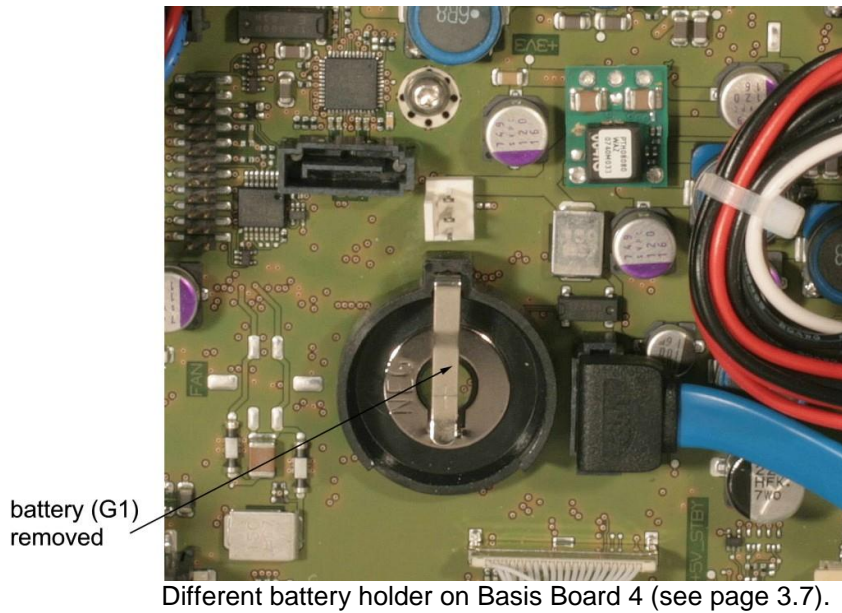

Note: 3.0 V lithium battery ($\varnothing 24,5 \text{ mm} * 7,7 \text{ mm}$, type CR2477N), see also “[Overview of the Modules](#)”, page 3.51.

- Insert new battery into holder below the spring.

Note: The positive pole (+) of the battery should point up.

- Attach the trough (300) and screw-fasten it with the six screw-and-washer assemblies (310).

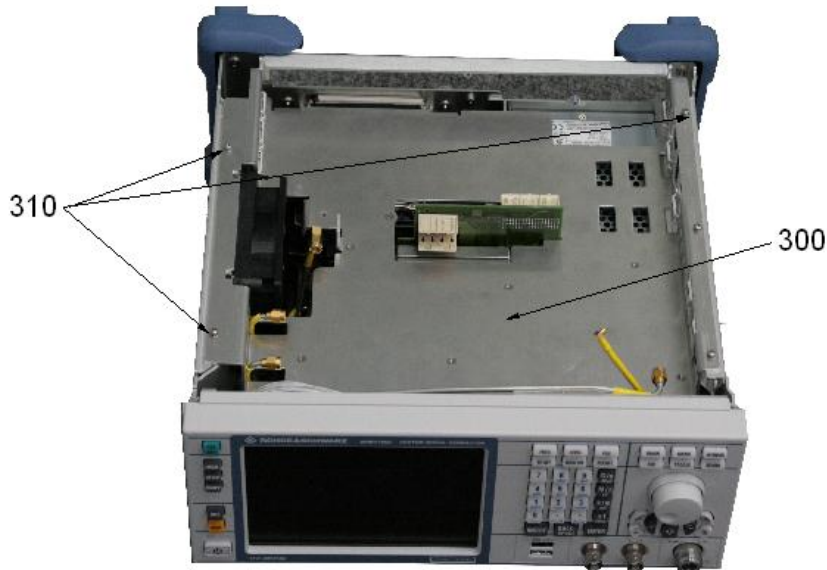

- Attach the vector board A500 (see page 3.79).
- If the R&S SMBV-B10/-B50/-B51 baseband generator A600 is included, mount it (see page 3.77).
- If the R&S SMBV-B92 option is included, replace it (see page 3.73).
- Mount the cabinet (see page 3.55).

Replacing the R&S SMBV-B1/-B1H Reference Oscillator

(see chapter 5, drawing and parts list 1407.6004.01).

Removing the R&S SMBV-B1/-B1H Reference Oscillator

- Unscrew the three screw-and-washer assemblies (1030).
- Carefully remove the reference oscillator (1020).

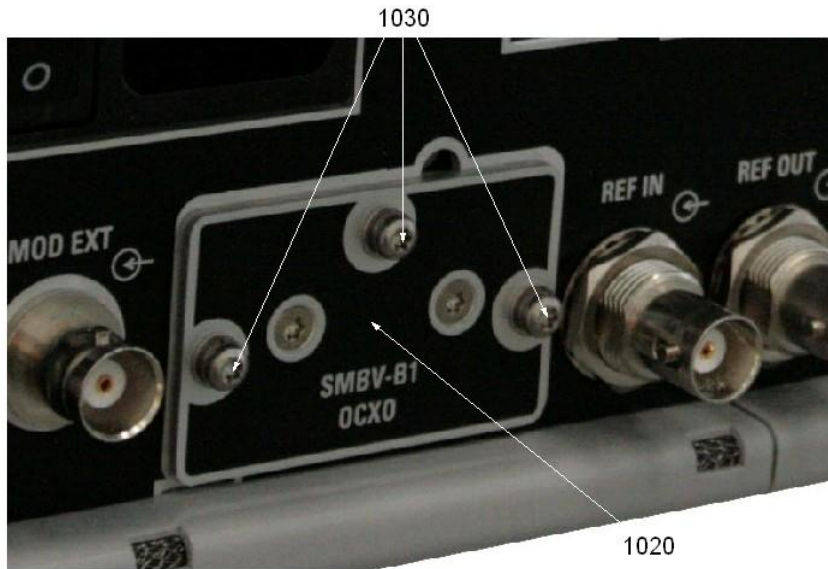

Installing the R&S SMBV-B1/-B1H Reference Oscillator

- Carefully attach the reference oscillator A210 (1020).

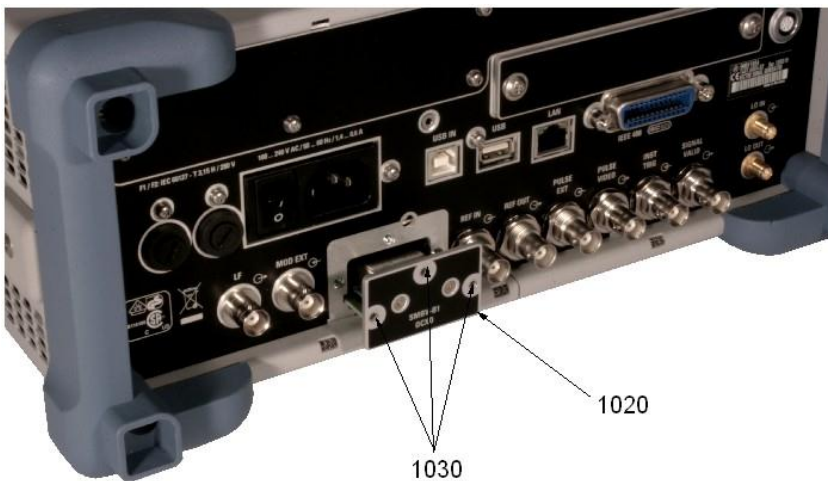

- Fasten the reference oscillator A210 (1020) with the three screw-and-washer assemblies (1030).

Contents - Chapter 4 "Software Update/Installing Options"

4 Software Update / Installing Options	4.1
Installation of New R&S SMBV Firmware.....	4.1
Maintenance System	4.2
Installing the Options.....	4.5
Hardware Options	4.5
Software Options.....	4.6

4 Software Update / Installing Options

This chapter contains information on firmware update, Linux operating system update and installing options to the R&S SMBV. Additional manuals obtained together with a firmware update or with subsequently acquired options can be filed here.

NOTICE

Possible impairment of the functioning of the instrument!

The instrument is equipped with the Linux operating system. It is thus possible to install COTS software in the instrument. The use and installation of commercial off-the-shelf (COTS) software may impair the instrument function. For this reason, we recommend that you only execute programs tested by Rohde&Schwarz with regard to their compatibility with the instrument software. In certain cases, the use of these programs can impair the performance of the instrument.

The drivers and programs used in the instrument under Linux have been adapted to the test instrument. Existing instrument software must only be modified with update software released by Rohde & Schwarz.

Installation of New R&S SMBV Firmware

Your R&S SMBV is delivered with the latest firmware version available. Firmware updates as well as the Release Notes describing the improvements and modifications are provided on the Internet at the download site of the R&S SMBV homepage <http://www.rohde-schwarz.com/product/smbv100a>. This homepage always offers the latest information on your signal generator, e.g. also on **changes of the firmware update procedure**.

Firmware updates always are delivered in one single file with a filename starting with "SMBV_" and ending in ".rsu". The version numbers in the filename vary with each update.

Firmware update: `SMBV_x.xx.xx.rsu`

The installation of a new firmware version is performed via the USB interface. A deinstallation of the old firmware is not necessary.

The update file has to be downloaded from the Internet to a PC. From there the file should be transferred to a memory stick which will later be plugged into the USB interface of the instrument. The firmware update is performed while the instrument is running. The new firmware will be loaded right after the update process.

If the instrument "sees" a memory stick at its USB interface, it offers all versions stored on the memory stick for selection. Thus, an upgrade or downgrade of the firmware is possible at any time.

Installing the firmware

NOTICE**Risk of impairment of instrument function!**

To avoid impairment of instrument functions, the update of the firmware must not be cancelled and the instrument must not be switched off during this update.

1. Switch on the instrument and wait until it is operational.
2. Plug in the memory stick which contains the update file (previously downloaded from the Internet) to the USB interface of the instrument.
3. Wait until the software update dialog appears and confirm the update.
4. Select the firmware version to be installed with the cursor up/down keys and press the rotary knob to activate your selection. The selected version will be installed.
5. Wait until the software update completed message appears.
6. Remove USB stick and press the rotary knob to reboot.
7. When the new/updated firmware is up and running, execute internal adjustments after a warmup time of approx. 10 minutes.
 - Press the **SETUP** key on the instrument front panel, select **Internal Adjustments** and execute **Adjust All**.
This process updates internal instrument adjustments and can take several minutes. Adjustments requiring external measurement equipment are not affected by the firmware update and need not to be performed.

Maintenance System

R&S SMBV provides a maintenance system. A backup of the delivery configuration is stored per default and can be recovered in case of a system crash.

In addition, the maintenance system offers the following functionality:

- **Reset power on settings**
This function removes the instrument settings saved during the last power off sequence. Instrument restarts using PRESET configuration.
- **Factory Recover**
This function restores the instrument to delivery configuration, including the system password. User data and instrument settings are lost irrevocably.
- **Backup internal memory to USB**
This function writes the system configuration to a USB stick. With exception of the factory recovery data the whole system data will be saved, including operating system, firmware and user data. To protect user data, this function requires knowledge of the system password.
- **Install Firmware Package**
This function forces a complete reinstallation of a firmware update package from USB and frees the remaining mass memory. User data and instrument settings are lost.

- **Sanitize internal memory**

This function erases all flash memory cells of the writeable area of the internal mass memory.

It is provided to irrevocably remove confidential user data from instrument, including information hidden in deleted files of partially filled sectors.

Note that the instrument is equipped with a flash file system. User data can not be reliably destroyed by overwriting files since new memory locations are allocated for most write operations.

So sanitizing is performed by applying low level sector erase instruction to the corresponding flash memory sectors and verifying their successful operation.

To enable future instrument operation, the following items are excluded from sanitizing:

- Basic boot code
- Linux Kernel
- FPGA configuration data
- Factory recovery data

These areas are write protected during normal operation and therefore are not able to store any information about the history of usage.

After sanitizing, a firmware installation or factory recovery is required, followed by execution of internal adjustments.

- **Initialize Harddisk**

This function partition and formats the harddisk. All user data saved on the harddisk are lost irrevocably.

- **Rescue Mode**

This function is for Rohde & Schwarz internal use. It's main purpose is for assembly and device error diagnostic.

Start the maintenance system

1. Switch the instrument off and on again
2. When the R&S SMBV boot screen with the message “Press rotary knob for maintenance” appears press the rotary knob.

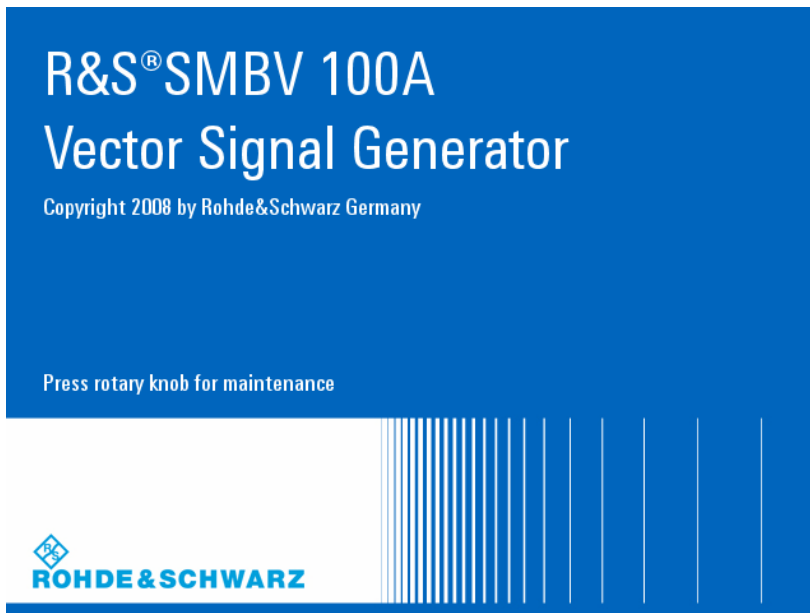

3. The maintenance systems starts, when the message “Booting maintenance system ...” appears.

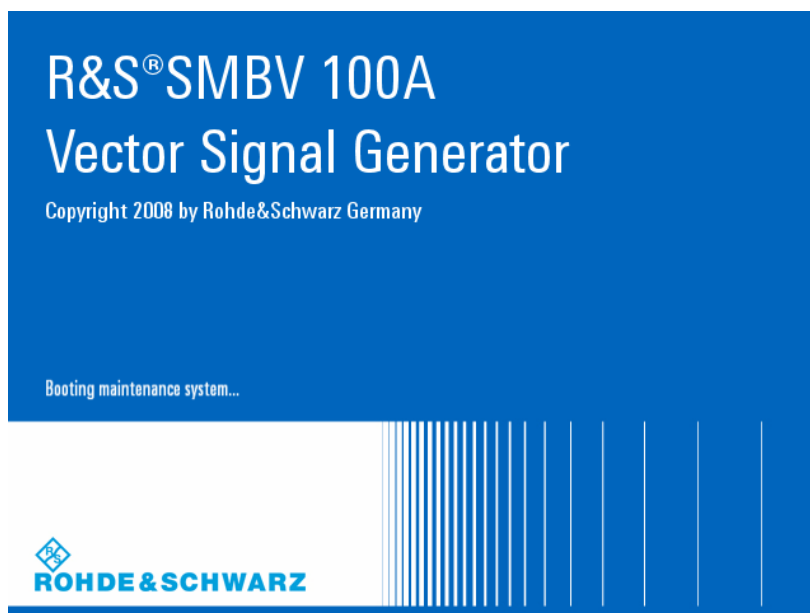

Installing the Options

A list of all available R&S SMBV options is provided in the data sheet and on the internet <http://www.rohde-schwarz.com/product/smbv100a>.

Hardware Options

Installation and replacement of hardware options is described in chapter 3 of this service manual.

Please also note the mounting instructions enclosed with the options. These mounting instructions can be filed at this place in the service manual and are thus easily available whenever they are required.

DANGER**Danger of shock hazard!**

For module replacement, ensure that the instrument is switched off and disconnected from the power supply by removing the plug from the AC and DC power connector.

Read all safety instructions at the beginning of this manual carefully before module replacement!

NOTICE**Danger of damage to components of the module!**

Protect the operational site against electrostatic discharge to avoid damage to electronic components of the modules. For details refer to the safety instructions at the beginning of this manual.

The **SETUP** **Installed Options** menu provides information on the already installed options.

Software Options

All available software options are already included in the latest firmware. They are ready to operate after they are enabled by means of a key code supplied with the option.

Only if the R&S SMBV is equipped with an older firmware version, a firmware update prior to enabling the software option may be required. The information on the valid firmware versions for the purchased software option is provided together with the option.

The key code is to be entered into the **SETUP** **Install SW Option** menu.

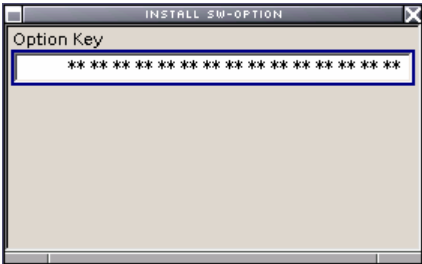

The **SETUP** **Installed Options** menu provides information on the already installed options

Contents - Chapter 5 "Documents"

- 5 Documents.....5.1
 - Spare Parts.....5.1
 - Available Power Cables5.2

5 Documents

This chapter contains the spare parts list and the documents for the complete R&S SMBV unit. For general information about spare parts for our products please refer to the sheet "Procedure in Case of Service and Ordering of Spare Parts" at the beginning of this manual.

Spare Parts

The stock numbers necessary for ordering replacement parts and modules can be found in the component lists further down.

DANGER**Danger of shock hazard!**

For module replacement, ensure that the instrument is switched off and disconnected from the power supply by removing the plug from the AC and DC power connector.

Read all safety instructions at the beginning of this manual carefully before module replacement!

NOTICE**Risk of damage to the module!**

When shipping a module be careful to provide for sufficient mechanical and antistatic protection.

Available Power Cables

Table 5-1 List of power cables available

Stock No.	Earthed-contact connector	Preferably used in
DS 0006.7013.00	BS1363: 1967' 10 A, 250 V complying with IEC 83: 1975 standard B2	Great Britain
DS 0006.7020.00	Type 12, 10 A, 250 V complying with SEV-regulation 1011.1059, standard sheet S 24 507	Switzerland
DS 0006.7036.00	Type 498/13, 10 A, 250 V complying with US-regulation UL 498, or with IEC 83	USA/Canada
DS 0041.4752.00	GB2099, GB1002, 10 A, 250 V approvals CCC	China
DS 0041.6232.00	JIS C 8303, 7A, 125 V AC approvals PSE (JET)	Japan
DS 0006.7107.00	Type SAA3, 10 A, 250 V, complying with AS C112-1964 Ap.	Australia
DS 0025.2365.00 DS 0099.1456.00	DIN 49 441, 10 A, 250 V, angular DIN 49 441, 10 A, 250 V, straight approvals VDE, ÖVE, CEBEC, KEMA, S, D, N, FI, LCIE, IMQ, UCIEE	Europe (except Switzerland)

R&S SMBV100A

Spare Parts List

Für diese Unterlage behalten wir uns alle Rechte vor.
Ausgedruckte Dokumente unterliegen nicht dem Änderungsdienst.
For this document all rights are reserved.
Printed documents are not subject to revision

Pos.-Nr. ItemNo	Menge Quantity	ME Unit	El.Kennz Ref.Des.	Benennung / Bezeichnung Designation	Z	Sachnummer Stock No.	Ersatzteil Subst.part	BA	VH
				ACHTUNG EGB/ATTENTION ESD *VARIANTENERKLAERUNG *EXPLANATION OF MODELS VAR02=GRUNDVARIANTE MOD02=BASIC MODEL					
5 0		S		ZS ERSATZTEILLISTE VORHANDEN SPARE PARTS LIST AVAIL Sach-Nr. / Part No. 1407.6040.01 ST für SMBV100A und Optionen		0999.9684.00		M	O
15 1		S		ZM RAHMEN VORMONT. FUER SMBV EQUIPMENT FRAME FOR SMBV	Z	1407.6104.02		M	P
60 1		S	A50	NJ SCHALTNETZTEIL AC 90-264V 120W POWER SUPPLY		1406.7336.00	X	B	V
70 5		S		VS 6900/ISR-M2.5X8-A2 COMBI SCREW 6900/ISR-M2.5X8-A2		0041.1653.00		B	T
100 1		S	A100	ED BASISBOARD 4 BASIS BOARD 4	Z	1406.6900.02	X	M	P
105 1		S	A110	BC SMARTCARD SLE66 V4.4 SIM FORMAT SMARTCARD SLE66 V4.4 SIM FORMAT		3586.7860.00		B	I
110 6		S		VS 6900/ISR-M2.5X8-A2 COMBI SCREW 6900/ISR-M2.5X8-A2		0041.1653.00		B	T
150 1		S	A200	ED RF BOARD RF BOARD	Z	1406.7220.03	X	M	W
152 6		S		FJ FAECHERSCHEIBE SERRATED LOCKWASHER		3583.1578.00		B	O
154 6		S		FJ MUTTER HEX 16 1/2 -28UNEF HEX 16 NUT 1/2 -28UNEF		3585.2707.00		B	B
160 5		S		VS 6900/ISR-M2.5X20-A2 COMBI SCREW 6900/ISR-M2.5X20-A2		5302.0431.00		B	T
200 1		S	A700	ZM FRONTEINHEIT SMBV FRONTUNIT SMBV	Z	1407.8007.03		M	P
210 4		S		VS 965/ISR-M2.5X8-A4-PA 965/ISR-M2.5X8-A4-PA		1148.3294.00		B	T
250 1		S	W212V	DW HF-KABEL W212V RF-CABLE W212V	Z	1407.6504.00	X	M	W
255 4		S		VS SCHRAUBE WN1552 DG 2.5X6 DIE CAST SCREW 2.5X6		1300.4457.00		B	O
270 1		S	W115	DG SATA DATENKABEL 265 SATA DATACABLE 265		1091.3440.00		B	O
300 1		S		MZ WANNE TROUGH	Z	1407.6210.00		M	P
310 7		S		VS 6900/ISR-M2.5X8-A2 COMBI SCREW 6900/ISR-M2.5X8-A2		0041.1653.00		B	T
312 1		S		VS DIN6797-A2.7-A2 TOOTH WASHER DIN6797-A2.7-A2		0016.2814.00		B	O
320 2		S		KM LP-FUEHRUNG 65.0MM BEARING		1300.4340.00		B	O
330 4		S		VS 965/ISR-M3X6-A4-PA 965/ISR-M3X6-A4-PA		1148.2781.00		B	O
350 1		S	A550	ED LI BRIDGE LI BRIDGE	Z	1407.7400.02	X	M	P



ROHDE & SCHWARZ

Benennung/Designation

SMBV100A VECTOR SIGNAL GENERATOR
SMBV100A VECTOR SIGNAL GENERATOR

Sprach./Lang
de en

Ä.I. / C.I
24.00

Blatt/Sheet
1 of 3

Dokument Nr. / Document No.

1407.6004.01 ST

SMBV100A

Datum/
Date 2013-04-17

Abt. /
Dept. MTEK

Name /
Name HM

Für diese Unterlage behalten wir uns alle Rechte vor.
 Ausgedruckte Dokumente unterliegen nicht dem Änderungsdienst.
 For this document all rights are reserved.
 Printed documents are not subject to revision

Pos.-Nr. ItemNo	Menge Quantity	ME Unit	El.Kennz Ref.Des.	Benennung / Bezeichnung Designation	Z	Sachnummer Stock No.	Ersatzteil Subst.part	BA	VH
360	3	S		VS 6900/ISR-M2.5X8-A2 COMBI SCREW 6900/ISR-M2.5X8-A2		0041.1653.00		B	T
400	1	S	X92	FP SATA ADAPTER VERSCHLEISSFREI SATA ADAPTOR		1308.0280.00	X	B	B
410	2	S		VS 6900/ISR-M2.5X10-A2 COMBI SCREW 6900/ISR-M2.5X10-A2		0041.1660.00		B	T
420	1	S	W141	DG SATA DATENKABEL 265 SATA DATACABLE 265		1091.3440.00		B	O
430	1	S	W142	DF SATA VERSORGUNGSKABEL 285 SATA POWERCABLE 285		1091.3427.00		B	O
450	1	S	A500	ED VECTORBOARD VECTOR BOARD	Z	1407.7500.02	X	M	P
460	5	S		VS 6900/ISR-M2.5X25-A2 COMBI SCREW 6900/ISR-M2.5X25-A2		3584.5502.00		B	O
500	1	S	W140	DY SENSOR KABEL SENSOR CABLE	Z	1407.6656.00	X	M	W
510	1	S	W214	DV HF KABEL W214 RF CABLE W214	Z	1407.6627.00		M	L
520	1	S	W215	DV HF KABEL W215 RF CABLE W215	Z	1407.6633.00		M	W
530	1	S	W213	DV HF KABEL W213 RF CABLE W213	Z	1407.6610.00		M	W
540	1	S	W222	DY KABEL BB-RF-BOARD CABLE BB-RF-BOARD	Z	1406.8110.00		M	P
550	1	S	W211	DW HF-KABEL W211 RF-CABLE W211	Z	1407.6527.00		M	P
580	1	S	W216	DW HF-KABEL W216 RF-CABLE W216	Z	1407.6533.00		M	P
590	2	S		DZ KABELBI.RD 1 BIS 25 B2 CABLETIE		0015.9038.00		B	O
600	1	S		KB RUECKWAND 2 REAR PANEL 2	Z	1406.6281.00		M	P
610	1	S		KB ABDECKPL. F. BBGEN-SLOT LACKIERT PANEL FOR BBGEN SLOT	Z	1407.6385.00		M	T
620	9	S		VS 6900/ISR-M2.5X10-A2 COMBI SCREW 6900/ISR-M2.5X10-A2		0041.1660.00		B	T
640	1	S		KB ABDECKPL. F. HDD-SCHACHT LACKIERT COVER FOR HDD SLOT	Z	1407.6427.00		M	T
660	2	S		VS 965/ISR-M4X6-A4-PA 965/ISR-M4X6-A4-PA		1148.2800.00		B	T
665	2	S		MP ABDECKKAPPE RD6.4 COVER		0009.9181.00		B	O
680	2	S		OS EGB-SCHILD 14X30 (12X28) WARNING LABEL FOR ESDS		0061.1520.00		M	O
700	1	S		MZ TUBUS 3E 3/4 T350 SMBV VORMONT. TUBE SMBV, MOUNTED	Z	1407.6291.00		M	W
710	1	S		KR BW2-SCHUTZECK VO.LI.3E HART PROTECTIVE CORNER FRONT LEFT		1096.6653.00		B	V



ROHDE & SCHWARZ

Benennung/Designation

SMBV100A VECTOR SIGNAL GENERATOR
SMBV100A VECTOR SIGNAL GENERATOR

Sprach./Lang
de en

Ä.I. / C.I.
24.00

Blatt/Sheet
2 of 3

Dokument Nr. / Document No.

1407.6004.01 ST

SMBV100A

Datum/
Date 2013-04-17

Abt. /
Dept. MTEK

Name /
Name HM

Für diese Unterlage behalten wir uns alle Rechte vor.
 Ausgedruckte Dokumente unterliegen nicht dem Änderungsdienst.
 For this document all rights are reserved.
 Printed documents are not subject to revision

Pos.-Nr. ItemNo	Menge Quantity	ME Unit	El.Kennz Ref.Des.	Benennung / Bezeichnung Designation	Z	Sachnummer Stock No.	Ersatzteil Subst.part	BA	VH
720	1	S		KR BW2-SCHUTZECK VO.RE.3E HART PROTECTIVE CORNER FRONT RIGHT 3HU		1096.6660.00		B	V
725	4	S		VS SCHR. M4X14 PA SCREW M4X14		1096.4909.00		B	V
730	1	S		KR BW2-SCHUTZECK HI.LI.3E HART PROTECTIVE COVER REAR LEFT 3HU		1096.6676.00		B	V
740	1	S		KR BW2-SCHUTZECK HI.RE.3E HART PROTECTIVVER REAR RIGHT 3HU		1096.6682.00		B	V
800	1	S		HS FIRMWARE SMBV FIRMWARE SMBV	Z	1407.6140.00		M	O
805	1	S		HS FONT MICROSOFT ARIAL WGL FONT MICROSOFT ARIAL WGL		3584.9795.00		B	O
815	1	S		OS KC SCHILD SMBV LABEL KC SMBV geklebt auf Rückwand		1407.8294.00		M	P

 ROHDE & SCHWARZ	Benennung/Designation SMBV100A VECTOR SIGNAL GENERATOR SMBV100A VECTOR SIGNAL GENERATOR			Sprach./Lang de en	Ä.I. / C./ 24.00	Blatt/Sheet 3 of 3
	SMBV100A	Datum/ Date 2013-04-17	Abt. / Dept. MTEK	Name / Name HM	Dokument Nr. / Document No. 1407.6004.01 ST	

Für diese Unterlage behalten wir uns alle Rechte vor.
 Ausgedruckte Dokumente unterliegen nicht dem Änderungsdienst.
 For this document all rights are reserved.
 Printed documents are not subject to revision

Pos.-Nr. ItemNo	Menge Quantity	ME Unit	El.Kennz Ref.Des.	Benennung / Bezeichnung Designation	Z	Sachnummer Stock No.	Ersatzteil Subst.part	BA	VH
				ACHTUNG EGB/ATTENTION ESD *VARIANTENERKLAERUNG *EXPLANATION OF MODELS VAR02=GRUNDVARIANTE MOD02=BASIC MODEL					
20	1	S		MZ U-RAHMEN BESCHRIFTET U FRAME	Z	1407.6191.00		M	
30	2	S		MZ Dichtungsfeder L=12.05 MZ SEAL SPRING L=12.05	Z	1143.8881.00		M	
50	1	S		MZ RECHNERWANNE PROCESSOR TROUGH	Z	1406.6246.00		M	
60	1	S		ZN NETZTEILWANNE POWER SUPPLY TROUGH	Z	1407.6233.00		M	
80	1	S		MZ FUEHRUNGSBLECH FUER OCXO PANEL FOR OCXO	Z	1407.6240.00		M	
110	3	S		DZ DURCHF.TUELLE 10X17X6.8 GROMMET 10X17X6.8		0099.1433.00		B	O
130	12	S		VN BLINDNIET 3.2X5.8 ST BLIND RIVET 3.2X5.8 ST		1096.4821.00		B	O
142	1	S	E1	DX LUEFTEREINHEIT (92MM) FAN UNIT	Z	1407.6279.00	X	M	
144	1	S		EV LUEFTERMANS. 92X92X4 T=1.5-2.5 FRILL FOR FAN		2112.3032.00		B	T
180	1	S		VS 965/ISR-M3X10-A4-PA 965/ISR-M3X10-A4-PA		1148.3320.00		B	O
190	2	S		VS DIN6797-A3.2-A2 TOOTHED LOCK WASHERS		0016.2820.00		B	O
200	1	S		VS DIN125-A3.2-A4 WASHER DIN125		0082.4670.00		B	V
210	1	S		VS DIN934-M3-A4 NUT DIN 934-M3		0016.4398.00		B	O



ROHDE & SCHWARZ

Benennung/Designation

**RAHMEN VORMONT. FUER SMBV
EQUIPMENT FRAME FOR SMBV**

Sprach./Lang
de en

Ä.I. / C.I
05.00

Blatt/Sheet
1 of 1

Dokument Nr. / Document No.

1407.6104.01 ST

SMBV100A

Datum/
Date 2008-11-03

Abt. /
Dept. 1GPK

Name /
Name HI

Für diese Unterlage behalten wir uns alle Rechte vor.
 Ausgedruckte Dokumente unterliegen nicht dem Änderungsdienst.
 For this document all rights are reserved.
 Printed documents are not subject to revision

Pos.-Nr. ItemNo	Menge Quantity	ME Unit	El.Kennz Ref.Des.	Benennung / Bezeichnung Designation	Z	Sachnummer Stock No.	Ersatzteil Subst.part	BA	VH
				ACHTUNG EGB/ATTENTION ESD *VARIANTENERKLAERUNG *EXPLANATION OF MODELS VAR02=GRUNDVARIANTE MOD02=BASIC MODEL VAR03=MIT DREHIMPULSGEBER UND KNOBBOARD MOD03=WITH ROTARY PULSE GENERATOR AND KNOBBOARD VAR04=NEUER DREHIMPULSGEBER UND BASISBOARD 4 MOD04=NEW ROTARY PULSE GENERATOR AND BASISBOARD 4					
20	1	S		KB FRONTH. SMBV F.0852.2876 DREHIMP DV FRONT COVER SMBV F.0852.2876 ROTARY DV VAR 03 04	Z	1407.8236.00		M	W
22	1	S		KB FRONTHAUBE SMBV DV FRONT COVER SMBV DV VAR 02	Z	0283.8687.00		M	G
25	.85	M		EK HF-DICHTUNG O-PROF 2.0 SI SEALING		0396.1035.00		B	T
32	1	S		MM SCHUTZKRAGEN 9.6X13.9 SHROUD		0852.1234.00		B	O
40	1	S		SF SCHALTMATTE SMBV RUBBER KEYPAD SMBV	Z	1407.8036.00	X	B	B
50	1	S	A320	SF SCHALTFOLIE SMBV FLEX. SWITCHBOARD		1407.8020.00	X	B	B
62	1	S		MZ TAST. + LCD-HALTEBLECH F LCD M LED KEYBOARD + LCD PANEL	Z	1407.8088.00		M	P
65	0	S		MZ TAST. + LCD-HALTEBL. F LCD + MESH KEYBOARD + LCD PANEL + MESH	Z	1407.8188.00		M	
72	8	S		VS SCHRAUBE WN1552 DG 2.5X6 DIE CAST SCREW 2.5X6		1300.4457.00		B	O
102	1	S		OP SCHEIBE FSL SCREENED FILTER GLASS		1300.4311.00		B	B
103	4	S		MZ DÄMPFUNGSECKE GLASSCHEIBE ABSORBER GLASS PLATE		1300.4992.00		M	W
105	0	S		OP FILTERSCHEIBE SMF SCREENED FILTER GLASS		1167.0768.00		B	B
107	0	S		EK HF-FEDER		1069.3128.00		M	P
108	0	S		MZ HF-FEDER (137) RF SPRING	Z	1069.3105.00		M	W
112	1	S		MZ STAUBABDICHTUNG POWDER SEAL	Z	1407.8042.00		M	W
130	1	S		MZ SCHIRMWANNE LCD SHIELD TROUGH LCD	Z	1407.8142.00		M	P
140	1	S	A710	ND TFT 6.5 VGA LVDS LED (AUO) TFT 6.5 VGA LVDS LED (AUO)		5702.6056.00	X	B	T
152	4	S		VS 6900/ISR-M2.5X5-A2 COMBI SCREW 6900/ISR-M2.5X5-A2		0041.1630.00		B	T
162	4	S		VS 7985/ISR-M2.5X4-A4-PA		1148.2717.00		B	T



ROHDE & SCHWARZ

Benennung/Designation

**FRONTEINHEIT SMBV
FRONTUNIT SMBV**

Sprach./Lang
de en

Ä.I. / C.I
15.00

Blatt/Sheet
1 of 2

Dokument Nr. / Document No.

1407.8007.01 ST

SMBV100A

Datum/
Date 2013-08-22

Abt. /
Dept. MTEK

Name /
Name EI

Für diese Unterlage behalten wir uns alle Rechte vor.
 Ausgedruckte Dokumente unterliegen nicht dem Änderungsdienst.
 For this document all rights are reserved.
 Printed documents are not subject to revision

Pos.-Nr. ItemNo	Menge Quantity	ME Unit	El.Kennz Ref.Des.	Benennung / Bezeichnung Designation	Z	Sachnummer Stock No.	Ersatzteil Subst.part	BA	VH
280	1	S	A310	7985/ISR-M2.5X4-A4-PA ED ENCODER BOARD ENCODER BOARD VAR 02	Z	1300.3044.02	X	M	P
281	1	S	A310	EM DREHIMP. L18 (ACHSE 17) M. TASTE ROTARY PULS-GENERATOR VAR 03 04		0852.2901.00	X	B	T
282	1	S		MM KRAGEN M. MUTTER COLLER WITH NUT VAR 03 04	Z	0852.2699.00		B	O
285	1	S	A311	ED KNOB BOARD KNOB BOARD VAR 03	Z	1407.7246.02	X	M	P
286	2	S		VS 6900-3 Z4/ISR-M2X5-A2 COMBI SCREW 6900-3 Z4/ISR-M2X5-A2 VAR 03		2109.1378.00		B	B
290	1	S	W111	DF FLEX-STRIP 10P R=0.5 L=250 OBEN- OBE FLEX-STRIP 10POL VAR 02 04		1407.8113.00		B	B
291	1	S	W111	DF FLEX STRIP 10P R0.5 L90 FLEX STRIP 10P R0.5 L90 VAR 03		1314.3458.00		B	B
292	1	S	W112	DF FLEX-STRIP 10P. R=0.5 L=300 FLEX-STRIP 10P. R=0.5 L=300 VAR 03		3584.3368.00		B	O
302	2	S		VS SCHRAUBE WN1552 DG 2.5X6 DIE CAST SCREW 2.5X6 VAR 02		1300.4457.00		B	O
322	1	S		MM KRAGEN F.DREHIMPULSGEBER COLLAR ENCODER VAR 02		0852.1105.00		B	T
332	1	S		OK DREH.RD28 ACHS-RD6 KNOB		0852.1086.00		B	V
340	2	S		EK FEDERSTREIFEN SPRING STRIP	Z	1300.3438.00		M	W
352	1	S	A720	ED USB 2.0 HUB USB 2.0 HUB	Z	1411.2000.02	X	M	W
355	1	S		MZ HALTEBLECH F. FRONT CONTR. HOLDER	Z	1407.6227.00		M	W
362	2	S		VS SCHRAUBE WN1552 DG 2.5X6 DIE CAST SCREW 2.5X6		1300.4457.00		B	O
390	1	S	W113	DF DISPLAYKABEL AUO 200MM DISPLAYCABLE AUO 200MM		1407.8159.00	X	B	B
395	1	S	W114	DX LCD LED INPUT CABLE LCD LED INPUT CABLE	Z	1407.8136.00		M	W
402	2	S		VS 6900/ISR-M2.5X6-A2 COMBI SCREW 6900/ISR-M2.5X6-A2		1148.3059.00		B	T
422	1	S	W501	DV HF KABEL W501 RF CABLE W501	Z	1407.6556.00		M	W
432	1	S	W502	DV HF KABEL W502 RF CABLE W502	Z	1407.6562.00		M	W



ROHDE & SCHWARZ

Benennung/Designation

**FRONTEINHEIT SMBV
FRONTUNIT SMBV**

Sprach./Lang
de en

Ä.I. / C.I.
15.00

Blatt/Sheet
2 of 2

Dokument Nr. / Document No.

1407.8007.01 ST

SMBV100A

Datum/
Date 2013-08-22

Abt. /
Dept. MTEK

Name /
Name EI

Für diese Unterlage behalten wir uns alle Rechte vor.
 Ausgedruckte Dokumente unterliegen nicht dem Änderungsdienst.
 For this document all rights are reserved.
 Printed documents are not subject to revision

Pos.-Nr. <i>ItemNo</i>	Menge <i>Quantity</i>	ME <i>Unit</i>	El.Kennz <i>Ref.Des.</i>	Benennung / Bezeichnung <i>Designation</i>	Z	Sachnummer <i>Stock No.</i>	Ersatzteil <i>Subst.part</i>	BA	VH
				ACHTUNG EGB/ATTENTION ESD *VARIANTENERKLAERUNG *EXPLANATION OF MODELS VAR02=GRUNDVARIANTE MOD02=BASIC MODEL					
1620	1	S	A750	NM HDD 2.5 SATA 160GB MK1676GSX HDD 2.5 SATA 160GB MK1676GSX		3587.7306.00	X	B	T
1630	1	S	A750.2	ZM HDD-HALTERUNG MONT., OHNE HDD HDD MOUNTING UNIT	Z	1407.6440.00	X	M	P
1640	2	S	A750.3 A750.4	MP HARDDISKHALTER 2.5 HOLDER		1201.8161.00	X	B	O

 ROHDE & SCHWARZ	Benennung/ <i>Designation</i> SMBV-B92 FESTPLATTE SMBV-B92 HARD DISC			Sprach./Lang de en	Ä.I. / C./ 06.00	Blatt/Sheet 1 of 1
	SMBV-B92	Datum/ Date 2011-11-23	Abt. / Dept. MTEK	Name / Name EI	Dokument Nr. / Document No. 1407.9403.01 ST	

Für diese Unterlage behalten wir uns alle Rechte vor.
 Ausgedruckte Dokumente unterliegen nicht dem Änderungsdienst.
 For this document all rights are reserved.
 Printed documents are not subject to revision

Pos.-Nr. <i>ItemNo</i>	Menge <i>Quantity</i>	ME <i>Unit</i>	El.Kennz <i>Ref.Des.</i>	Benennung / Bezeichnung <i>Designation</i>	Z	Sachnummer <i>Stock No.</i>	Ersatzteil <i>Subst.part</i>	BA	VH
				ACHTUNG EGB/ATTENTION ESD *VARIANTENERKLAERUNG *EXPLANATION OF MODELS VAR02=GRUNDVARIANTE MOD02=BASIC MODEL					
1820	1	S		OS FREQUENZSCHILD 9KHZ ... 3.2GHZ FREQUENCY LABEL		1407.8165.00		B	B
1830	1	S		PD INSTALLATION MANUAL INSTALLATION MANUAL	Z	1407.9626.00		M	

 ROHDE & SCHWARZ	Benennung/ <i>Designation</i> SMBV-B103 9KHZ ... 3.2GHZ SMBV-B103 9KHZ TO 3.2GHZ				Sprach./Lang de en	Ä.I. / C./ 03.00	Blatt/Sheet 1 of 1
	SMBV-B103	Datum/ Date 2008-11-03	Abt. / Dept. 1GPK	Name / Name HI	Dokument Nr. / Document No. 1407.9603.01 ST		

Für diese Unterlage behalten wir uns alle Rechte vor.
 Ausgedruckte Dokumente unterliegen nicht dem Änderungsdienst.
 For this document all rights are reserved.
 Printed documents are not subject to revision

Pos.-Nr. <i>ItemNo</i>	Menge <i>Quantity</i>	ME <i>Unit</i>	El.Kennz <i>Ref.Des.</i>	Benennung / Bezeichnung <i>Designation</i>	Z	Sachnummer <i>Stock No.</i>	Ersatzteil <i>Subst.part</i>	BA	VH
				ACHTUNG EGB/ATTENTION ESD *VARIANTENERKLAERUNG *EXPLANATION OF MODELS VAR02=GRUNDVARIANTE MOD02=BASIC MODEL					
1920	1	S		OS FREQUENZSCHILD 9KHZ ... 6GHZ FREQUENCY LABEL		1407.8171.00		B	B
1930	1	S		PD INSTALLATION MANUAL INSTALLATION MANUAL	Z	1407.9726.00		M	

 ROHDE & SCHWARZ	Benennung/ <i>Designation</i> SMBV-B106 9KHZ ... 6GHZ SMBV-B106 9KHZ TO 6GHZ			Sprach./Lang de en	Ä.I. / C./ 03.00	Blatt/Sheet 1 of 1
	SMBV-B106	Datum/ <i>Date</i> 2008-11-03	Abt. / <i>Dept.</i> 1GPK	Name / <i>Name</i> HI	Dokument Nr. / Document No. 1407.9703.01 ST	

Für diese Unterlage behalten wir uns alle Rechte vor.
 Ausgedruckte Dokumente unterliegen nicht dem Änderungsdienst.
 For this document all rights are reserved.
 Printed documents are not subject to revision

Pos.-Nr. ItemNo	Menge Quantity	ME Unit	El.Kennz Ref.Des.	Benennung / Bezeichnung Designation	Z	Sachnummer Stock No.	Ersatzteil Subst.part	BA	VH
				ACHTUNG EGB/ATTENTION ESD *VARIANTENERKLAERUNG *EXPLANATION OF MODELS VAR02=GRUNDVARIANTE MOD02=BASIC MODEL VAR04=GRUNDVARIANTE NEU MOD04=BASIC MODEL NEW					
1120	1	S	A600	ED BBGEN BOARD BBGEN BOARD VAR 02	Z	1407.7000.02	X	M	W
1122	1	S	A600	ED BBGEN BOARD 2 BBGEN BOARD 2 VAR 04	Z	1407.7046.02	X	M	
1130	1	S		ZB ZUBEHOER SM.-Bn/AM.-Bn ACCESS. SM.-Bn/AM.-Bn	Z	1141.7020.00		M	

 ROHDE & SCHWARZ	Benennung/Designation SMBV-B10 BASISBANDGENERATOR SMBV-B10 BASEBAND GENERATOR			Sprach./Lang de en	Ä.I. / C./ 04.00	Blatt/Sheet 1 of 1
	SMBV-B10	Datum/ Date 2012-11-20	Abt. / Dept. MTEK	Name / Name HM	Dokument Nr. / Document No. 1407.8607.01 ST	

Für diese Unterlage behalten wir uns alle Rechte vor.
 Ausgedruckte Dokumente unterliegen nicht dem Änderungsdienst.
 For this document all rights are reserved.
 Printed documents are not subject to revision

Pos.-Nr. <i>ItemNo</i>	Menge <i>Quantity</i>	ME <i>Unit</i>	El.Kennz <i>Ref.Des.</i>	Benennung / Bezeichnung <i>Designation</i>	Z	Sachnummer <i>Stock No.</i>	Ersatzteil <i>Subst.part</i>	BA	VH
				ACHTUNG EGB/ATTENTION ESD *VARIANTENERKLAERUNG *EXPLANATION OF MODELS VAR02=GRUNDVARIANTE MOD02=BASIC MODEL					
1150	1	S	A600	ED BBGEN BOARD 2 BBGEN BOARD 2	Z	1407.7046.04	X	M	
1160	1	S		ZB ZUBEHOER SM.-Bn/AM.-Bn ACCESS. SM.-Bn/AM.-Bn	Z	1141.7020.00		M	

 ROHDE & SCHWARZ	Benennung/ <i>Designation</i> SMBV-B10F SMBV-B10F			Sprach./Lang de en		Ä.I. / C./ 01.00	Blatt/Sheet 1 of 1
	SMBV-B10F	Datum/ <i>Date</i>	2012-11-20	Abt. / <i>Dept.</i>	MTEK	Name / <i>Name</i>	EI

Für diese Unterlage behalten wir uns alle Rechte vor.
 Ausgedruckte Dokumente unterliegen nicht dem Änderungsdienst.
 For this document all rights are reserved.
 Printed documents are not subject to revision

Pos.-Nr. <i>ItemNo</i>	Menge <i>Quantity</i>	ME <i>Unit</i>	El.Kennz <i>Ref.Des.</i>	Benennung / Bezeichnung <i>Designation</i>	Z	Sachnummer <i>Stock No.</i>	Ersatzteil <i>Subst.part</i>	BA	VH
				ACHTUNG EGB/ATTENTION ESD *VARIANTENERKLAERUNG *EXPLANATION OF MODELS VAR02=GRUNDVARIANTE MOD02=BASIC MODEL					
1220	1	S	A600	ED BBGEN BOARD BBGEN BOARD	Z	1407.7000.03	X	M	
1230	1	S		ZB ZUBEHOER SM.-Bn/AM.-Bn ACCESS. SM.-Bn/AM.-Bn	Z	1141.7020.00		M	

 ROHDE & SCHWARZ	Benennung/ <i>Designation</i> SMBV-B50 BASISBANDGENERATOR SMBV-B50 BASEBAND GENERATOR			Sprach./Lang de en		Ä.I. / C./ 03.00	Blatt/Sheet 1 of 1
	SMBV-B50	Datum/ Date	2010-01-26	Abt. / Dept.	1GPK	Name / Name	HI

Für diese Unterlage behalten wir uns alle Rechte vor.
 Ausgedruckte Dokumente unterliegen nicht dem Änderungsdienst.
 For this document all rights are reserved.
 Printed documents are not subject to revision

Pos.-Nr. ItemNo	Menge Quantity	ME Unit	El.Kennz Ref.Des.	Benennung / Bezeichnung Designation	Z	Sachnummer Stock No.	Ersatzteil Subst.part	BA	VH
				ACHTUNG EGB/ATTENTION ESD *VARIANTENERKLAERUNG *EXPLANATION OF MODELS VAR02=GRUNDVARIANTE MOD02=BASIC MODEL VAR04=GRUNDVARIANTE NEU MOD04=BASIC MODEL NEW					
1320	1	S	A600	ED BBGEN BOARD BBGEN BOARD VAR 02	Z	1407.7000.03	X	M	P
1322	1	S	A600	ED BBGEN BOARD 2 BBGEN BOARD 2 VAR 04	Z	1407.7046.03	X	M	
1330	1	S		ZB ZUBEHOER SM.-Bn/AM.-Bn ACCESS. SM.-Bn/AM.-Bn	Z	1141.7020.00		M	

 ROHDE & SCHWARZ	Benennung/Designation SMBV-B51 BASISBANDGENERATOR SMBV-B51 BASEBAND GENERATOR			Sprach./Lang de en	Ä.I. / C./ 03.00	Blatt/Sheet 1 of 1
	SMBV-B51	Datum/ Date 2012-11-20	Abt. / Dept. MTEK	Name / Name HM	Dokument Nr. / Document No. 1407.9003.01 ST	

Für diese Unterlage behalten wir uns alle Rechte vor.
 Ausgedruckte Dokumente unterliegen nicht dem Änderungsdienst.
 For this document all rights are reserved.
 Printed documents are not subject to revision

Pos.-Nr. <i>ItemNo</i>	Menge <i>Quantity</i>	ME <i>Unit</i>	El.Kennz <i>Ref.Des.</i>	Benennung / Bezeichnung <i>Designation</i>	Z	Sachnummer <i>Stock No.</i>	Ersatzteil <i>Subst.part</i>	BA	VH
				ACHTUNG EGB/ATTENTION ESD *VARIANTENERKLAERUNG *EXPLANATION OF MODELS VAR02=GRUNDVARIANTE MOD02=BASIC MODEL					
1020	1	S	A210	EE OCXO OCXO	Z	1407.3105.04	X	M	
1030	3	S		VS 6900/ISR-M2.5X8-A2 COMBINATION SCREWS		0041.1653.00		B	T

 ROHDE & SCHWARZ	Benennung/ <i>Designation</i> SMBV-B1 REFERENZOSZILLATOR SMBV-B1 REFERENCE OSCILLATOR			Sprach./Lang de en	Ä.I. / C./ 04.00	Blatt/Sheet 1 of 1
	SMBV-B1	Datum/ <i>Date</i> 2010-05-20	Abt. / <i>Dept.</i> MTEK	Name / <i>Name</i> EI	Dokument Nr. / Document No. 1407.8407.01 ST	

Für diese Unterlage behalten wir uns alle Rechte vor.
 Ausgedruckte Dokumente unterliegen nicht dem Änderungsdienst.
 For this document all rights are reserved.
 Printed documents are not subject to revision

Pos.-Nr. ItemNo	Menge Quantity	ME Unit	El.Kennz Ref.Des.	Benennung / Bezeichnung Designation	Z	Sachnummer Stock No.	Ersatzteil Subst.part	BA	VH
				ACHTUNG EGB/ATTENTION ESD *VARIANTENERKLAERUNG *EXPLANATION OF MODELS VAR02=GRUNDVARIANTE MOD02=BASIC MODEL					
1520	1	S		DW HF-KABEL W503 RF-CABLE W503	Z	1407.6579.00		M	
1530	1	S		DW HF-KABEL W504 RF-CABLE W504	Z	1407.6585.00		M	
1540	2	S		DZ KABELBI.RD 1 BIS 25 B2 CABLETIE		0015.9038.00		B	O
1550	1	S		PD INSTALLATION MANUAL INSTALLATION MANUAL	Z	1407.9332.00		M	

 ROHDE & SCHWARZ	Benennung/Designation SMBV-B90 PHASENKOHAERENZ SMBV-B90 PHASE COHERENCE			Sprach./Lang de en	Ä.I. / C./ 03.00	Blatt/Sheet 1 of 1	
	SMBV-B90	Datum/ Date	2008-10-30	Abt. / Dept.	1GPK	Name / Name	HI
						Dokument Nr. / Document No. 1407.9303.01 ST	

R&S SMBV100A

Mechanical Drawings

Achtung EGB !
Caution ESD !

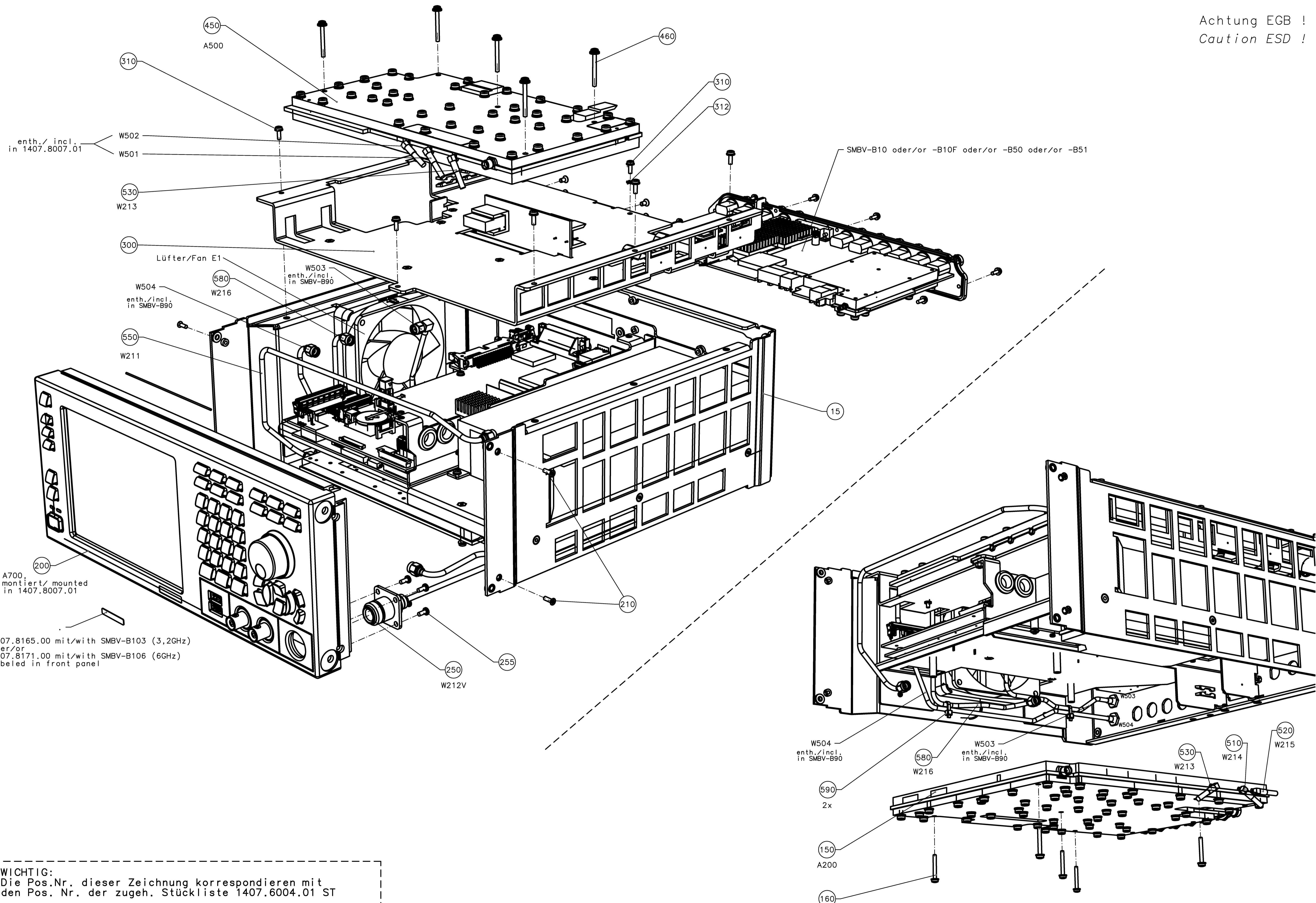

enth./incl.
in 1407.8007.01

W502
W501

530
W213

300
Lüfter/Fan E1

W504
enth./incl.
in SMBV-B90

550
W211

W503
enth./incl.
in SMBV-B90

SMBV-B10 oder/or -B10F oder/or -B50 oder/or -B51

A700,
montiert/ mounted
in 1407.8007.01

1407.8165.00 mit/with SMBV-B103 (3,2GHz)
oder/or
1407.8171.00 mit/with SMBV-B106 (6GHz)
labeled in front panel

250
W212V

W504
enth./incl.
in SMBV-B90

580
W216

W503
enth./incl.
in SMBV-B90

530
W213

510
W214

520
W215

590
2x

150
A200

160

WICHTIG:
Die Pos.Nr. dieser Zeichnung korrespondieren mit
den Pos. Nr. der zugeh. Stückliste 1407.6004.01 ST
IMPORTANT:
The item numbers of this drawing correspond to the item
numbers of the associated parts list 1407.6004.01 ST

Variantenerklärung: VAR02 = Grundausführung
Explanation of Models: MOD02 = Basic model

Modell Type	Skizzen Fig.	Werkstoff Material	Sprache / Lang. Lang. / C.F.	Blatt / 20
ROHDE & SCHWARZ	SMBV100A	SMBV100A VECTOR SIGNAL GENERATOR	de en	06.00 1
2012-11-20	2012-11-20	MTEK	hm	1407.6004.01 D

Für dieses Dokument behalten wir uns alle Rechte vor
For this document all rights are reserved

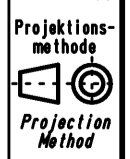

ACHTUNG EGB!
CAUTION ESD!

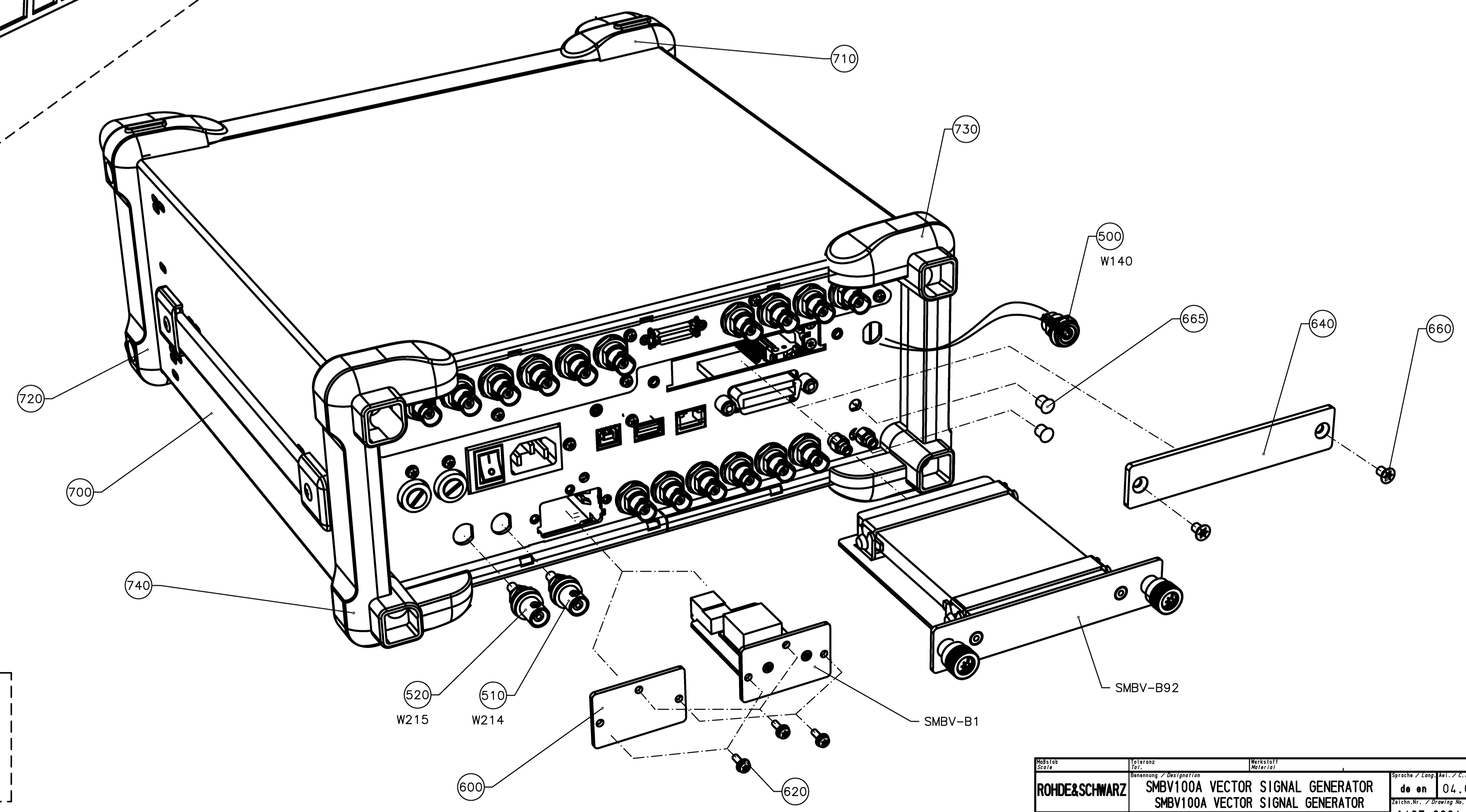
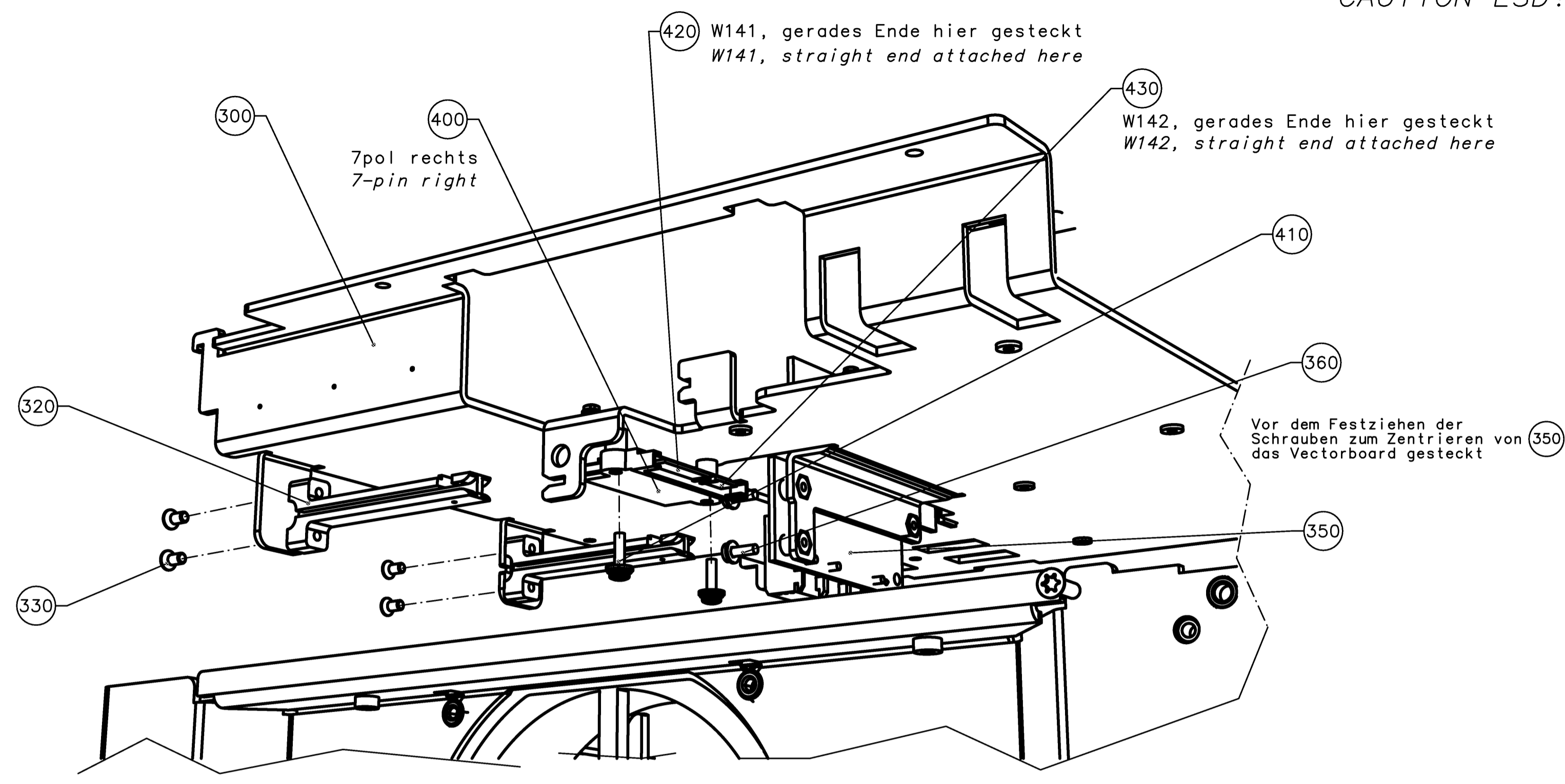
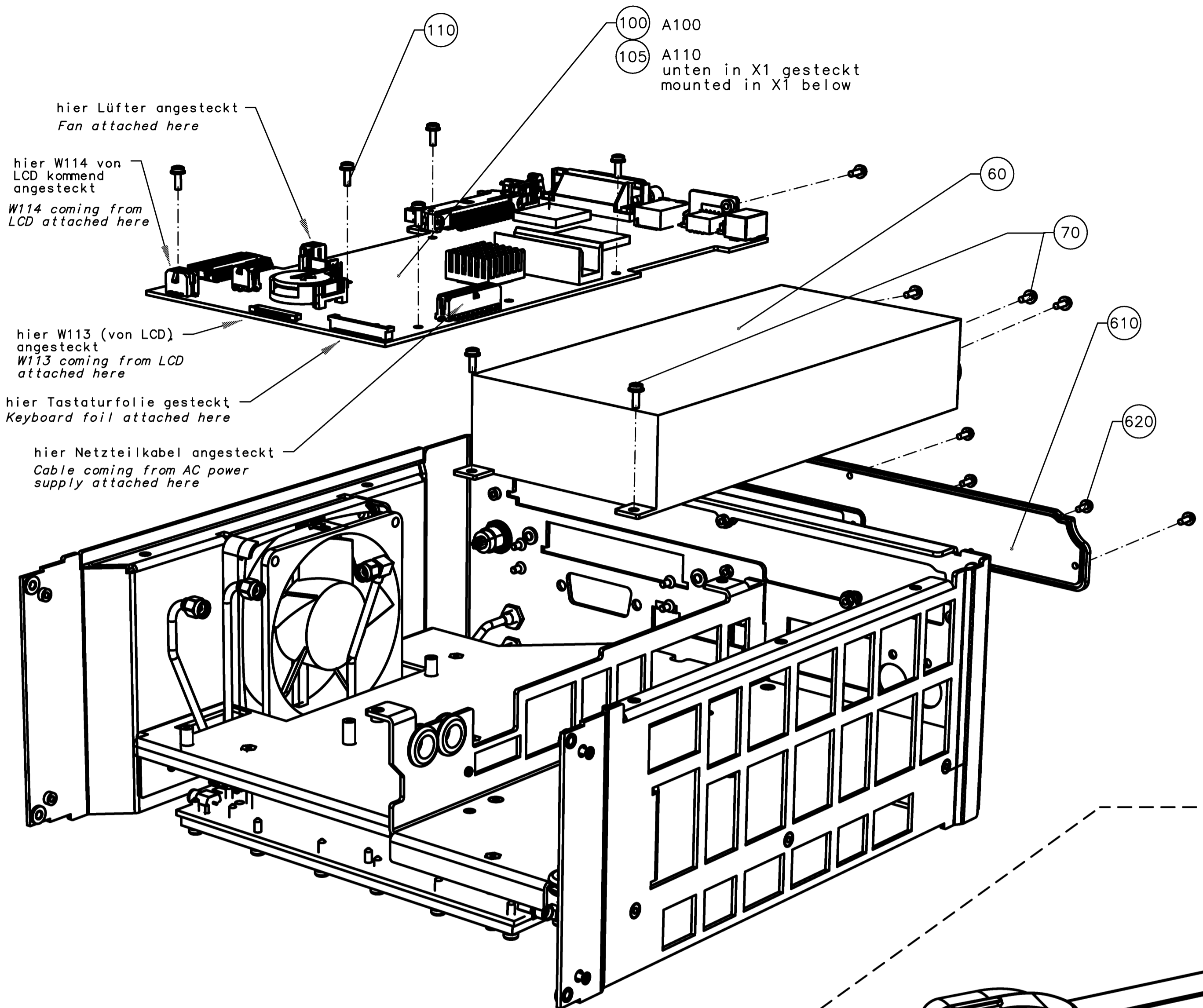

WICHTIG:
Die Pos.Nr. dieser Zeichnung korrespondieren mit den Pos. Nr. der zugeh. Stückliste 1407.6004.01 ST

IMPORTANT:
The item numbers of this drawing correspond to the item numbers of the associated parts list 1407.6004.01 ST

Modell Type	Bezeichnung / Designation	Werkstoff Material	Sprache / Lang. / C.F.	Blatt / 20
ROHDE&SCHWARZ	SMBV100A VECTOR SIGNAL GENERATOR		de en 04_00	2
SMBV100A	2011-03-30	MTEK	hm	1407.6004.01 D

Für dieses Dokument behalten wir uns alle Rechte vor
For this document all rights are reserved

ACHTUNG! EGB
CAUTION! ESD

142 Pfeil auf Luefter zur Gerateaussenseite zeigend, Kabelauslass nach vorne wie dargest.
Arrow of fan pointing to the outside of the instrument, cable outlet to the front

auf sichere Montage der Gummipoppen in den Schlüssellochern achten.
Make sure the rubber nubs are mounted securely in the keyholes

110 3x, vor dem Montieren in (60) jew. geschlitzt fuer das nachtraegliche Einlegen von Kabeln in die Tuellen
3x, before mounting in (60) each slotted for later insertion of cables into the spouts

2x genietet
2x riveted

130 5x genietet
5x riveted

2x genietet
2x riveted

130 3x genietet
3x riveted

die Lamellen an den Stirnseite des Durchbruchs anliegend, mittig +-1 geklebt
The lamellae lying dose on the face of the opening, centered +-1mm glued

Variantenerklaerung: VAR02 = Grundausfuehrung
Explanation of Models: MOD02 = Basic model

WICHTIG:
Die Pos.Nr. dieser Zeichnung korrespondieren mit den Pos. Nr. der zugeh. Stückliste 1407.6104.01 ST
IMPORTANT:
The item numbers of this drawing correspond to the item numbers of the associated parts list 1407.6104.01 ST

Maßstab Scale	1:2; 1,5	Toleranz Tol.	Werkstoff Material	Sprache / Lang. Lang. / C.I.	Blatt / Sh.
Benennung / Designation	ROHDE&SCHWARZ RAHMEN VORMONT, FUER SMBV EQUIPMENT FRAME FOR SMBV			de en	05.00
Datum Date	2007-08-07	Abteilung Dept.	16PK	Name Name	Hi
				Zeichn.Nr. / Drawing No.	1407.6104.01
					D

Für dieses Dokument behalten wir uns alle Rechte vor
For this document all rights are reserved

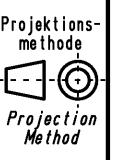

WICHTIG:
Die Pos.Nr. dieser Zeichnung korrespondieren mit den Pos. Nr. der zugeh. Stückliste 1407.8007.01 ST

IMPORTANT:
The item numbers of this drawing correspond to the item numbers of the associated parts list 1407.8007.01 ST

ACHTUNG EGB!
CAUTION ESD!

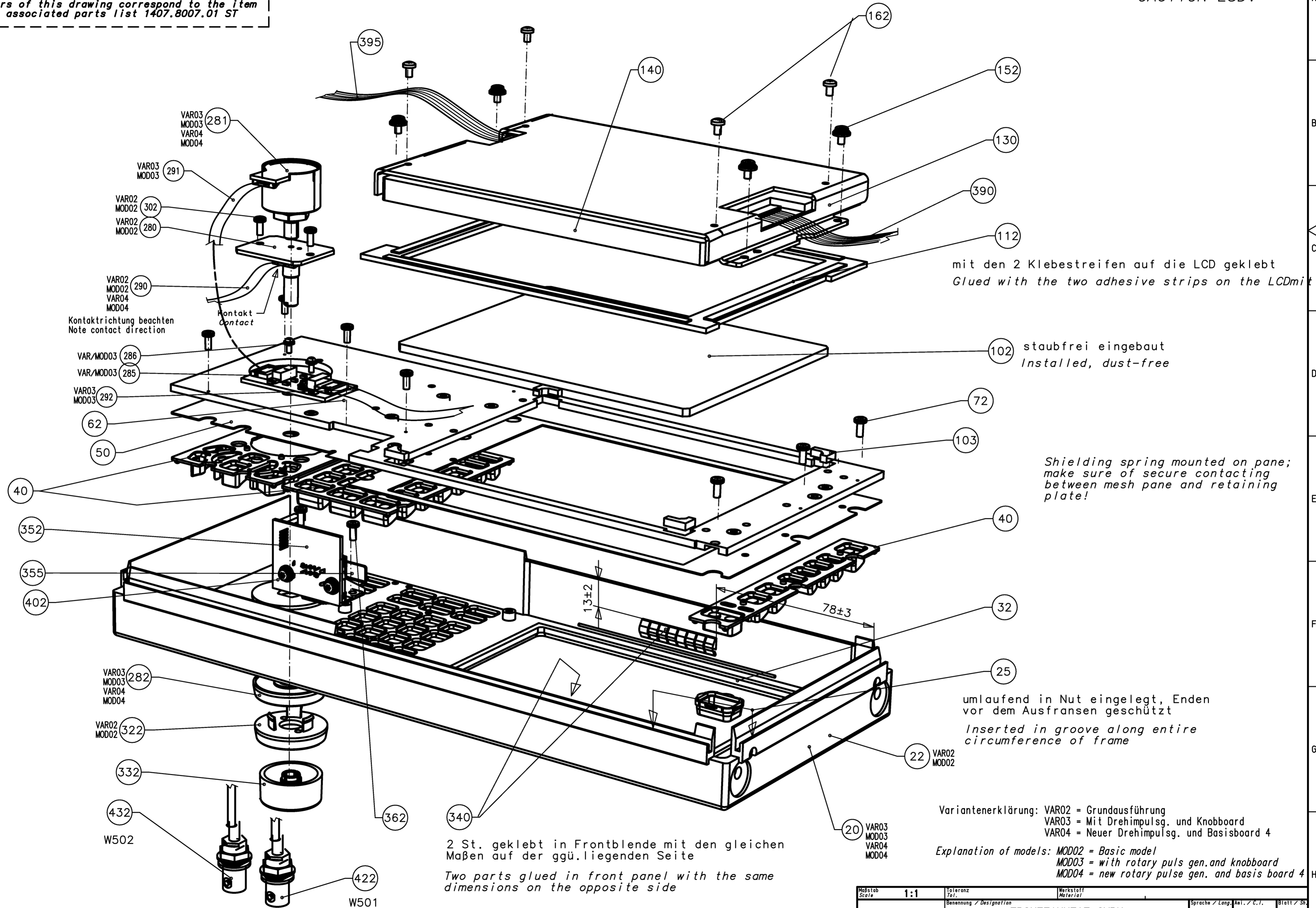

Maßstab Scale	1:1	Toleranz Tol.	Werkstoff Material	Sprache / Lang. / A. / C. / I.	Blatt / Sh.
Benennung / Designation	FRONTEINHEIT SMBV FRONTUNIT SMBV			de en	08.00 1
Datum Date	2013-08-22	Abteilung Dept.	MTEK	Zeichn.Nr. / Drawing No.	1407.8007.01 D
SMBV100A		Name	hm		

Für dieses Dokument behalten wir uns alle Rechte vor
For this document all rights are reserved

Projektions-
methode
Projection
Method

1

2

3

4

Achtung! ESG
Caution! ESD

Stifte in der Gummi-
Manschette müssen zur
Fixierung in die Gewinde
der Festplatte ragen.

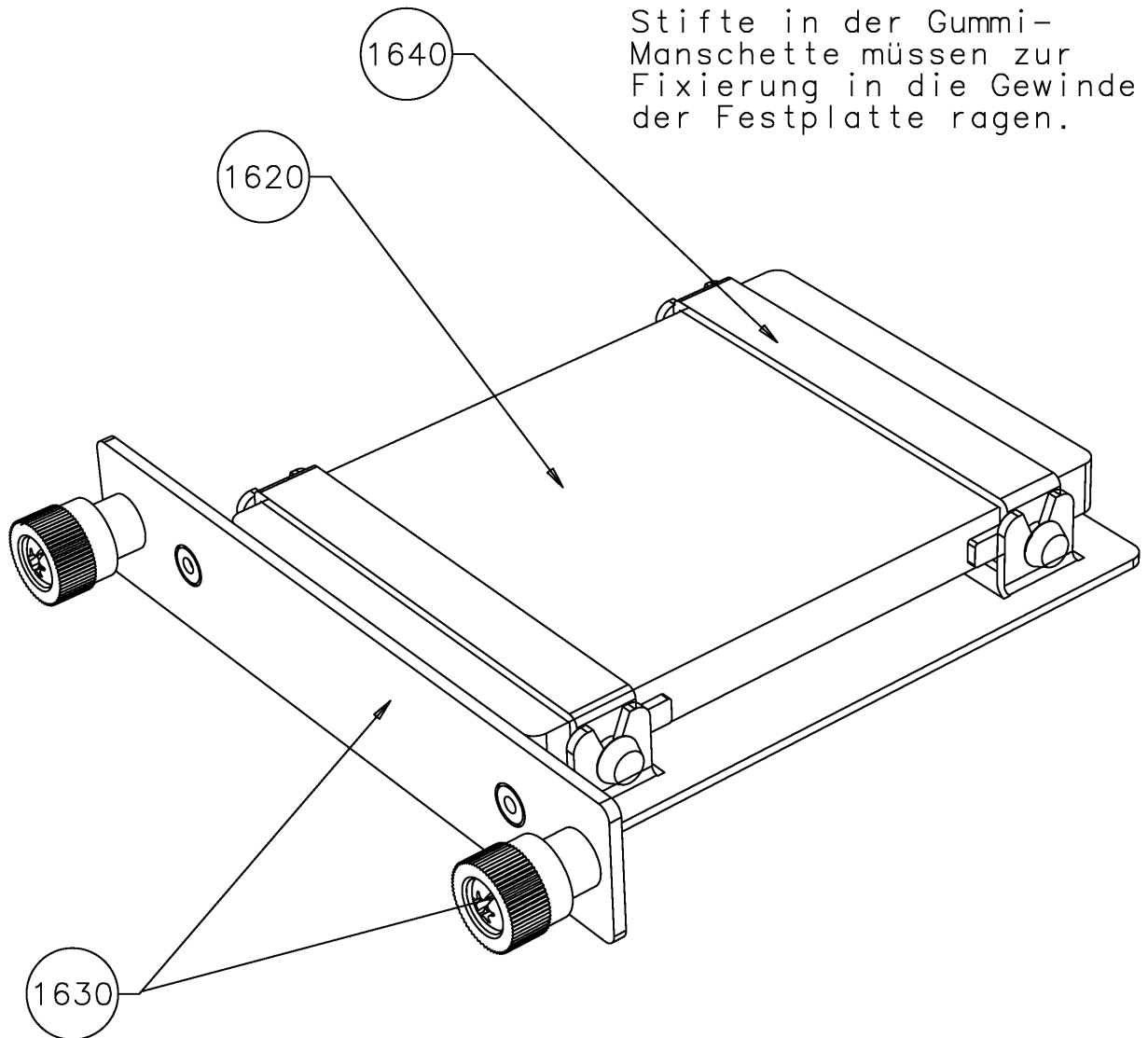

Für dieses Dokument behalten wir uns alle Rechte vor
For this document all rights are reserved

I

Projektions-
methode
Projection
Method

Variantenerklärung: VAR 02 = Grundausführung
Esplanation of models: MOD 02 = Basic model

Maßstab Scale	1:1	Toleranz Tol.	Werkstoff Material			Sprache / Lang. / Aei. / C.I.	Blatt / Sh.
ROHDE&SCHWARZ	Benennung / Designation					de en	1
	SMBV-B92 FESTPLATTE SMBV-B92 HARD DISC					Zeichn.Nr. / Drawing No.	
SMBV-B92	Datum Date	2008-04-02	Abteilung Dept.	1GPK	Name Name	Hi	1407.9403.01 D

1

2

3

4

F

F